

OWNER'S MANUAL



CMM-20

Marine Source Unit with LCD Display



Clarion®



FCC COMPLIANCE STATEMENT

This device complies with Part 15 of the FCC Rules. Operation is subject to the following two conditions: (1) this device may not cause harmful interference, and (2) this device must not accept any interference received, including interference that may cause undesired operation. These limits are designed to provide reasonable protection against harmful interference in a residential installation.

This equipment generates, uses and can radiate radio frequency energy and, if not installed in accordance with the instructions, may cause harmful interference to radio communications. However, there is no guarantee that interference will not occur in a particular installation. If this equipment does cause harmful interference to radio or television reception, the user is encouraged to try to correct the interference by one or more of the following measures:

- Reorient or relocate the receiving antenna.
- Increase separation between the equipment and the receiver.
- Connect the equipment to an outlet on a circuit different from that to which the receiver is connected.
- Consult the dealer or an experienced radio/TV technician for help.

Any changes or modifications not expressly approved by the party responsible for compliance could void the user's authority to operate this equipment.

SAFETY CONSIDERATIONS

- Only use this product in vehicles with 12 volt, negative-ground electrical systems. This product is not certified or approved for use in aircraft.
- Mount this product securely to prevent damage or injury in severe conditions.
- Do not replace the power wire fuse with one of a different value. Never bypass the fuse.
- Listen to your audio system at levels appropriate for operating conditions and hearing safety.

INSTALLATION CONSIDERATIONS

- Installation requires appropriate tools and safety equipment. Professional installation is recommended.
- This product is water-resistant. Do not submerge or subject to high-pressure water spray.
- Before installation, turn off the audio system and disconnect the battery system from the audio system.
- Install in a dry, well-ventilated location that does not interfere with your factory-installed systems. If a dry environment is not available, a location that is not exposed to heavy splashing may be used.
- Before cutting or drilling, check for potential obstacles behind mounting surfaces.
- Carefully route all system wiring away moving parts and sharp edges; secure with cable ties or wire clamps and use grommets and loom where appropriate to protect from sharp edges.

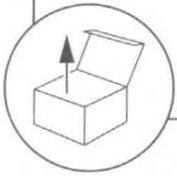
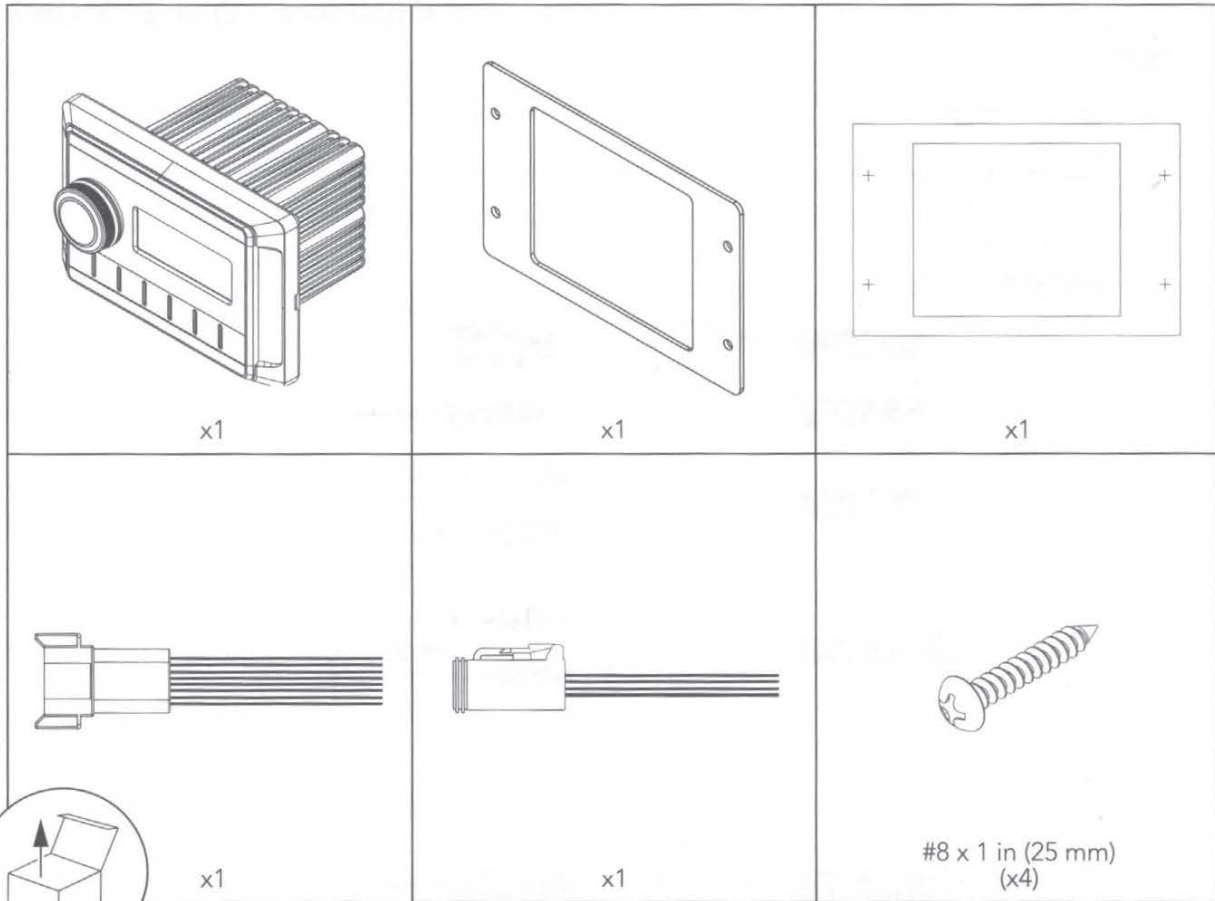

GENERAL MOUNTING

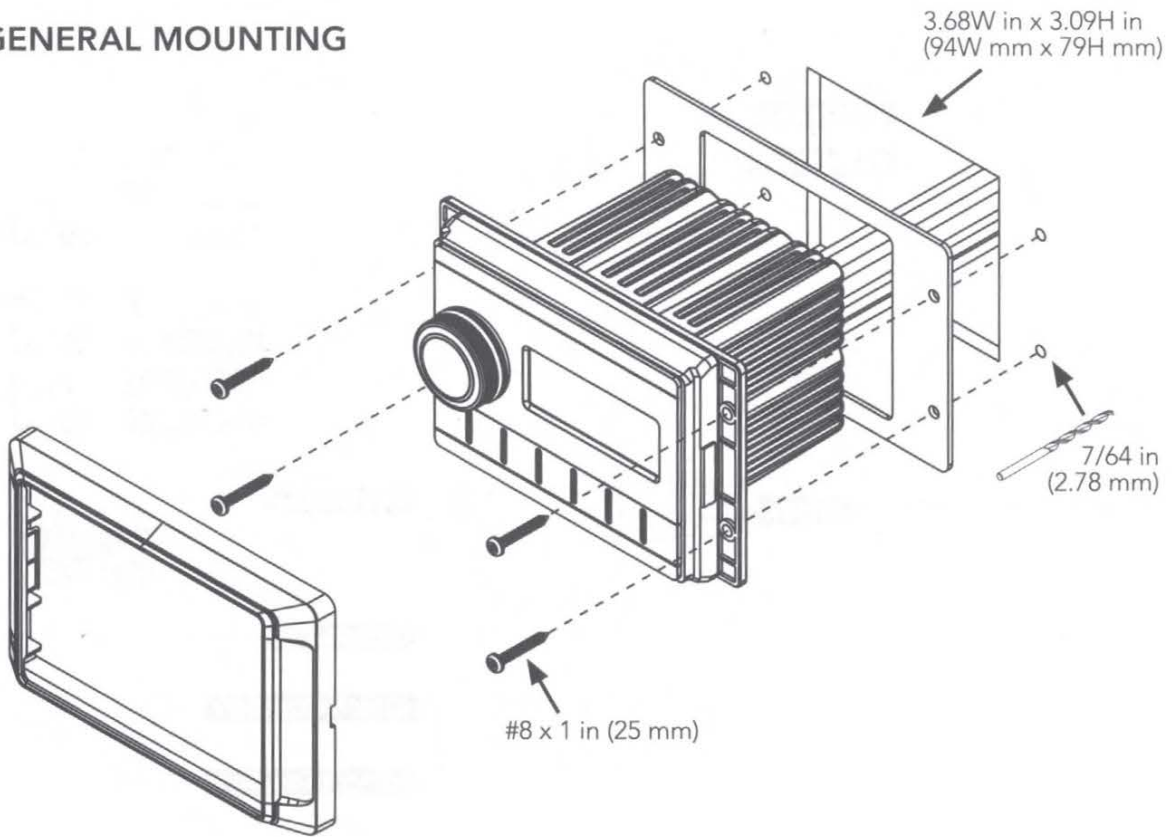

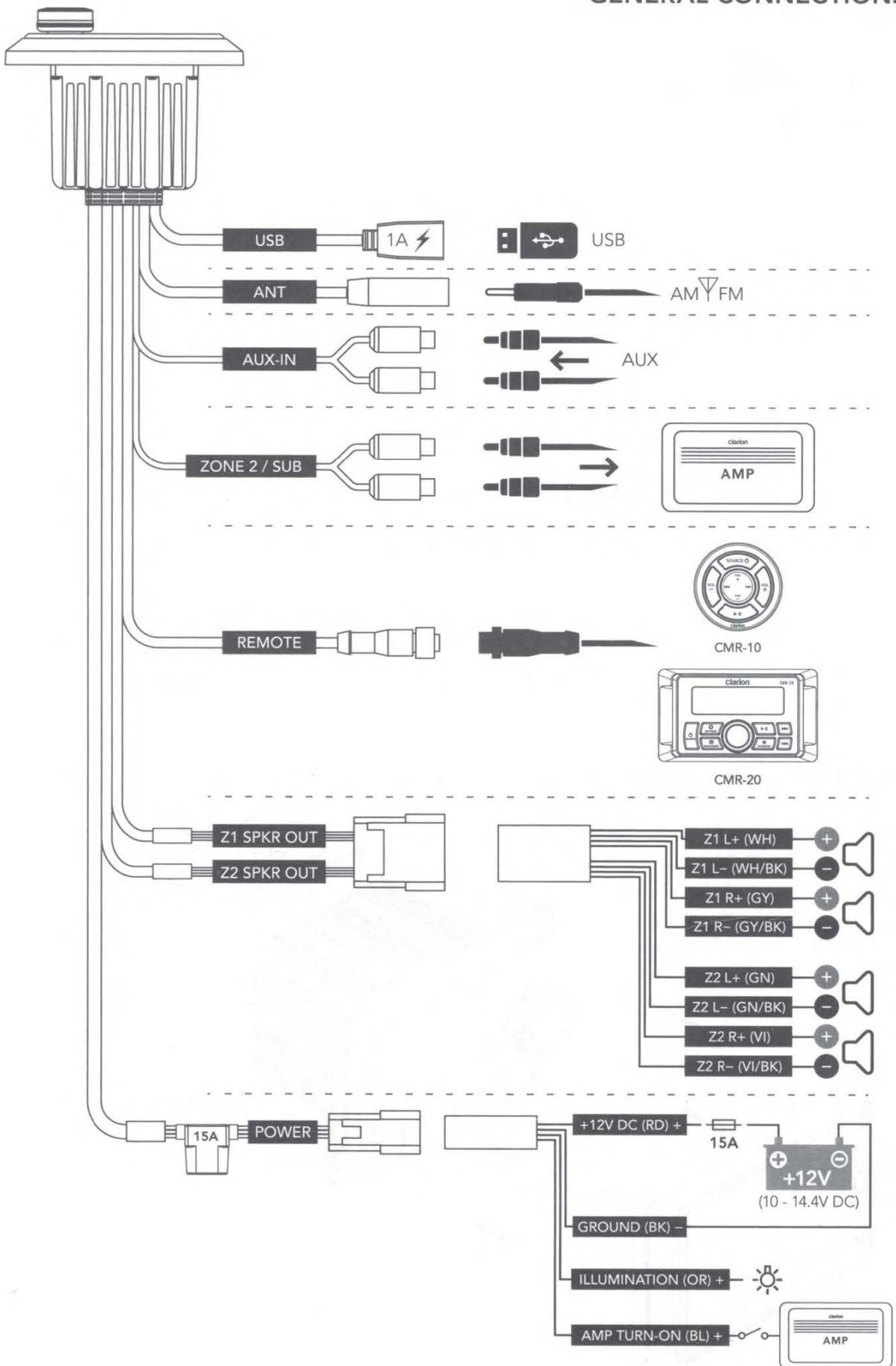

GENERAL CONNECTIONS



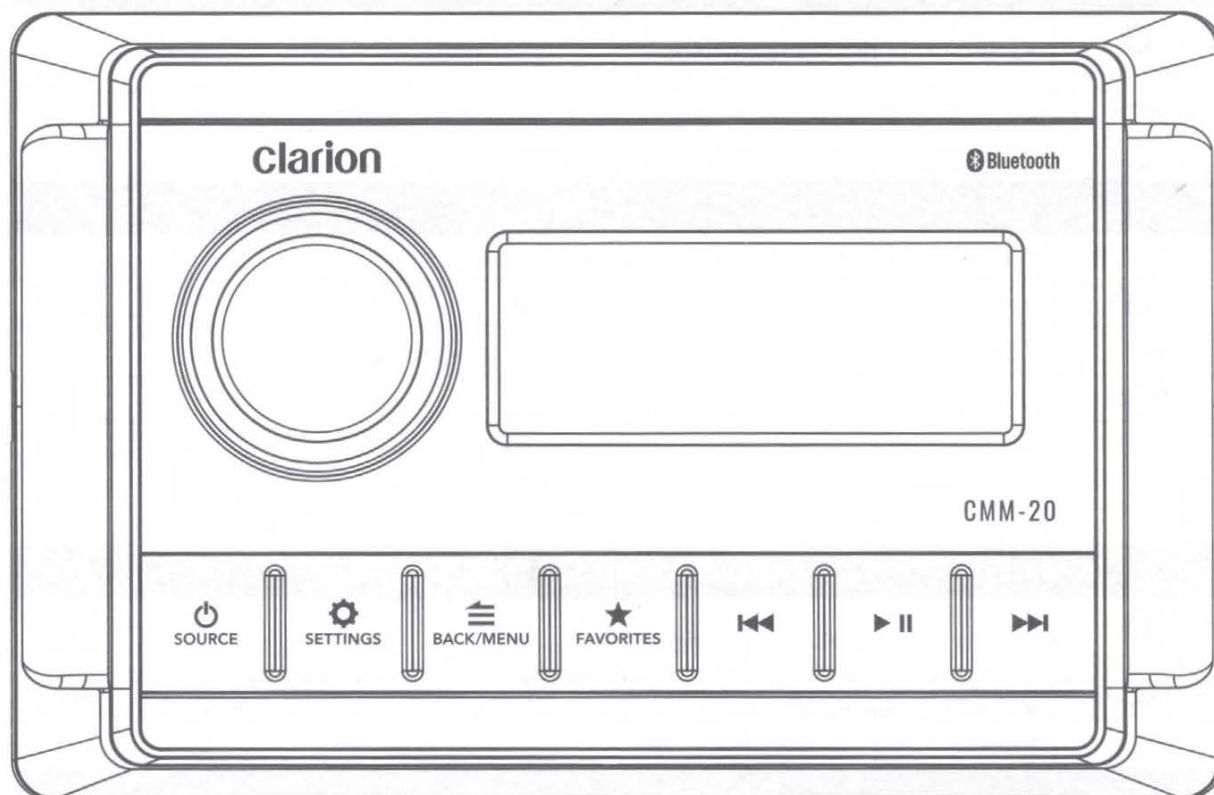



GENERAL CONTROL FUNCTIONS







Control	Function	
	Volume/ Select	<ul style="list-style-type: none"> • Rotate to adjust volume • Rotate/press for navigation and making selections
 SOURCE	Source/ Power	<ul style="list-style-type: none"> • Short press to turn ON; Long press to turn OFF • Short press to advance through available sources
 SETTINGS	Settings	<ul style="list-style-type: none"> • Short press to access audio settings (Bass/Treble/Balance/Fader/EQ) • Long press to access system settings (Z2-Sub/Beep/Area/Diagnostic)
 BACK/MENU	Back/ Menu	<ul style="list-style-type: none"> • Short press to go back one step or access source specific menus • Long press to advance through source specific menus
 FAVORITES	Favorites	<ul style="list-style-type: none"> • Short press to access stored presets • Long press to store a frequency as a preset (up to 9)
	Mute/ Pause	<ul style="list-style-type: none"> • Short press to mute/unmute audio (AM/FM/WB/AUX) or pause/resume the current selection (USB/Bluetooth)
	Forward	Short press to: <ul style="list-style-type: none"> • Manually adjust tuner forwards (AM/FM/WB) • Select the next track (USB/Bluetooth) Long press to: <ul style="list-style-type: none"> • Seek to the next channel (AM/FM/WB) • Fast-forward (USB/Bluetooth)
	Backward	Short press to: <ul style="list-style-type: none"> • Manually adjust tuner backwards (AM/FM/WB) • Restart track/select the previous track (USB/Bluetooth) Long press to: <ul style="list-style-type: none"> • Seek to the previous channel (AM/FM/WB) • Fast-rewind (USB/Bluetooth)



SYSTEM MENU SETTINGS	
 SETTINGS	<ul style="list-style-type: none"> • Long press to access settings
	<ul style="list-style-type: none"> • Rotate to navigate • Press to make selections
Setting	Function
Z2/SUB	Configures preamp outputs: Z2 (rear) or Subwoofer
BEEP	Audible button press confirmation: On or Off
AREA	Configures tuner region: USA, Europe, Australia or Other
DIAG	Displays software version for diagnostics

AUDIO MENU SETTINGS		
 SETTINGS	<ul style="list-style-type: none"> • Short press to access settings 	
	<ul style="list-style-type: none"> • Rotate to navigate • Press to make selections 	
Setting	Function	Note
BASS	Bass level control from -10 to +10	EQ must be set to Off
TREBLE	Treble level control from -10 to +10	
BALANCE	Balance control from full left (L10) to full right (R10)	
FADER	Fader control from full front (Z1:10) to full rear (Z2:10)	
SUB	Subwoofer preamp level control from 0 to +10	Z2/SUB must be set to SUB
EQ	Select EQ presets: Off, Flat, Pop, Classic, Rock	

FAVORITES MENU SETTINGS	
 FAVORITES	<ul style="list-style-type: none"> • Short press to access settings/stored presets • Long press to store a frequency as a preset (up to nine)
	<ul style="list-style-type: none"> • Rotate to navigate • Press to make selections
Setting	Function
DELETE	Select from stored presets for removal
REPLACE	Permits replacement when all nine preset locations are occupied

BLUETOOTH MENU SETTINGS	
 BACK/MENU	<ul style="list-style-type: none"> • Short press to access settings
	<ul style="list-style-type: none"> • Rotate to navigate • Press to make selections
Setting	Function
PAIR NEW DEVICE	Initiates Pairing Mode (current connected devices will be disconnected)
CONNECT PAIRED DEVICE	Display all paired devices for connection
SET PRIMARY DEVICE	Assign priority to a paired device for automatic connection
DELETE PAIRED DEVICE	Select from paired devices for removal
DELETE ALL DEVICES	Removes all paired devices from memory

USB MENU SETTINGS	
 BACK/MENU	<ul style="list-style-type: none"> • Short press to access settings
	<ul style="list-style-type: none"> • Rotate to navigate • Press to make selections
Setting	Function
RANDOM	Random playback of all tracks within all folders: On or Off
REPEAT	Repeats playback of the current track: On or Off
REPEAT FOLDER	Repeats playback of all tracks within a folder: On or Off
PLAY ALL	Plays all tracks within all folders: On or Off
FOLDERS LIST	Displays folders within the USB
TRACKS LIST	Displays tracks not located within a folder

AUX MENU SETTINGS	
 BACK/MENU	<ul style="list-style-type: none"> • Short press to access settings
	<ul style="list-style-type: none"> • Rotate to navigate • Press to make selections
Setting	Function
SENS	Configures AUX input sensitivity from -5 to +5

SPECIFICATIONS

Electrical	
Operating Voltage	14.4V DC (10V – 16V)
Operating Temp Range	-22 F to +167 F (-30 C to +75 C)
Current Draw / Fuse Value	15 A (max) / 33 mA (standby) / 15 A
Remote Turn-On Output	500 mA
Display	2.37 in. TFT LCD backlit
Tuner	
FM Tuner	USA: 87.9 MHz to 107.9 MHz (0.2 MHz step) EUR: 87.50 MHz to 108.00 MHz (0.05 MHz step) AUS: 87.50 MHz to 108.00 MHz (0.10 MHz step) OTHER: 87.50 MHz to 108.00 MHz (0.05 MHz step)
AM Tuner	USA: 530 kHz to 1710 kHz (10 kHz step) EUR: 531 kHz to 1602 kHz (9 kHz step) AUS: 531 kHz to 1629 kHz (9 kHz step) OTHER: 531 kHz to 1629 kHz (9 kHz step)
NOAA Weatherband	USA: 162.400 MHz - 162.550 MHz (0.025 MHz step)
Favorites	9 presets across all bands
Bluetooth®	
Profile	5.0
Core Specification / Codec	Version 2.1 + EDR / SBC
Connection Range	Up to 35 ft / 11 m
USB	
Interface	USB 2.0 High Speed
Supported Audio Formats	MP3, WMA, FLAC, WAV
File Limits	Folders: 255 Files in a single folder: 3,000 Total Files: 9,999
Charging Output	1 A
Preamp Audio Outputs/Inputs	
Output Channels	One stereo pair of RCA plugs (1.5V RMS)
Output Configuration	Selectable: Zone 2 or Subwoofer
Auxiliary Input Channels	One stereo pair of RCA plugs (2V RMS Max)
Amplified Audio Outputs	
Rated RMS Power @ 14.4V	25W x 4 @ 4 Ω
Audio Control Options	
Tone & Balance	Bass, Treble, Balance, Fader (Zone 1 / Zone 2 or Subwoofer)
EQ	Selectable: Off, Flat, Pop, Classic, Rock
Dimensions	
Unit W x H x D	5.95 in. x 3.90 in. x 3.15 in. (151 mm x 99 mm x 80 mm)
Mounting Hole W x H	3.68 in. x 3.09 in. (94 mm x 79 mm)

OPTIONAL REMOTE CONTROLLERS

Add control capabilities from auxiliary locations with optional wired remotes (sold separately). Connect up to three controllers to a single source unit, at up to 75 ft (23m) away (cumulative cable length). Each wired remote connects directly using controller cables and 2-way splitters (sold separately). Refer to the supplied Owner's Manual for specific user and installation instructions.

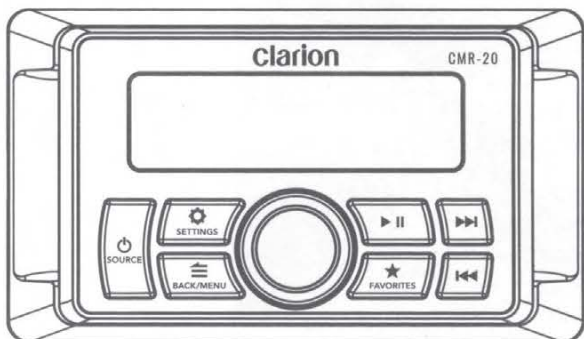

CMR-20
Wired Remote Controller
with LCD Display
Full-function, water-resistant
(IP67 rated) controller

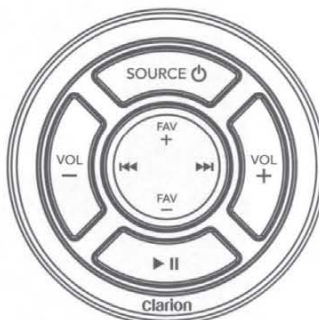

CMR-10
Wired Remote Controller
Auxiliary, water-resistant
(IP67 rated) controller

Clarion[®]





WARRANTY INFORMATION
MARINE/POWERSPORTS AUDIO

USA Limited Warranty

FOR MARINE AND POWERSPORTS AUDIO SOLD AT RETAIL:

Clarion Marine warrants this product to be free of defects in materials and workmanship for a period of one (1) year from the original date of purchase.

This warranty is not transferable and applies only to the original retail purchaser from an authorized Clarion Marine dealer in the USA. Should service be necessary under this warranty for any reason due to manufacturing defect or malfunction, Clarion Marine will (at its discretion), repair or replace the defective product with new or remanufactured product at no charge.

Note: Products purchased from unauthorized dealers are not covered under warranty.

Damage caused by the following is not covered under warranty: accident, misuse, physical abuse, product modification or neglect, failure to follow installation instructions, unauthorized repair attempts, misrepresentations by the seller. Loudspeakers with thermal or over-excursion damage are not covered under warranty. This warranty does not cover incidental, accidental or consequential damages and does not cover the cost of removing or reinstalling products. Cosmetic damage due to improper handling, accident or normal wear and tear or exposure to harsh chemicals is not covered under warranty. JL Audio will not be responsible for restoring or maintaining custom finishes or cosmetic treatments applied to products.

This warranty is void if the product's serial number has been removed, altered or defaced.

Any applicable implied warranties are limited in duration to the period of the express warranty as provided herein beginning with the date of the original purchase at retail, and no warranties, whether express or implied, shall apply to this product thereafter. Some states do not allow limitations on implied warranties, therefore these exclusions may not apply to you. This warranty gives you specific legal rights, and you may also have other rights which vary from state to state.

If you need service on your Clarion Marine product:

All USA retail warranty returns should be sent to Clarion Marine freight prepaid through an authorized Clarion Marine dealer and must be accompanied by proof of purchase (a copy of the original retail sales receipt.) Direct returns from consumers or non-authorized dealers will be refused unless specifically authorized by Clarion Marine with a valid return authorization number. Warranty expiration on products returned without proof of purchase will be determined from the manufacturing date code. Coverage may be invalidated as this date is prior to purchase date. Return only defective components. (If one speaker fails in a system, return only that speaker component, not the entire system.) Non-defective items received will be returned freight-collect. Customer is responsible for shipping charges and insurance in sending the product to Clarion Marine. Freight damage on returns is not covered under warranty.

Clarion Marine Customer Service:

1-954-443-1101

9:00 AM – 5:00 PM (Eastern Time Zone)

Clarion Marine Technical Support:

www.clarionmarine.com/support

Original Equipment Warranty

For Clarion Marine products installed as original equipment by a boat or vehicle manufacturer, warranty coverage is provided within the boat or vehicle manufacturer's warranty program. Please contact your boat dealer or manufacturer.

International Warranty

Warranty on products purchased outside the USA, European Economic Area (EEA) Member States and the Russian Federation is only valid within the country of purchase and products are covered by each country's Clarion Marine Distributor warranty program, and not directly by Clarion Marine. Please contact your local Clarion Marine retailer or distributor for warranty service.

Consumers in the EEA countries and the Russian Federation are protected by local consumer law and benefit from local statutory warranties.

Clarion Marine reserves the right to change or modify any of the terms and conditions contained in this Warranty Statement, at any time and in our sole discretion. Any changes or modification will be effective immediately upon posting of the revisions on the Clarion Marine website at www.clarionmarine.com/warranty, and you waive any right you may have to receive specific notice of such changes or modifications.