

# OWNER'S MANUAL

## M400/4

### 400W Marine 2/3/4 Channel Amplifier

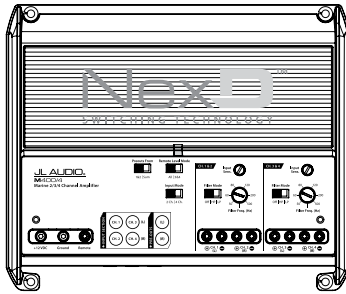

*Thank you for purchasing a JL Audio amplifier for your marine sound system.*

*Your amplifier has been designed and manufactured to exacting standards in order to ensure years of musical enjoyment in your vessel.*

*For maximum performance, we highly recommend that you have your new amplifier installed by an authorized JL Audio dealer. Your authorized dealer has the training, expertise and installation equipment to ensure optimum performance from this product. Should you decide to install the amplifier yourself, please take the time to read this manual thoroughly so as to familiarize yourself with its installation requirements and setup procedures.*

*If you have any questions regarding the instructions in this manual or any aspect of your amplifier's operation, please contact your authorized JL Audio dealer for assistance. If you need further assistance, please call the JL Audio Technical Support Department at (954) 443-1100 during business hours.*



## PROTECT YOUR HEARING!

We value you as a long-term customer. For that reason, we urge you to practice restraint in the operation of this product so as not to damage your hearing and that of others in your vessel. Studies have shown that continuous exposure to high sound pressure levels can lead to permanent (irreparable) hearing loss. This and all other high-power amplifiers are capable of producing such high sound pressure levels when connected to a speaker system. Please limit your continuous exposure to high volume levels.

While driving, operate your audio system in a manner that still allows you to hear necessary noises to operate your vessel safely (horns, sirens, etc.).

## SERIAL NUMBER

In the event that your amplifier requires service or is ever stolen, you will need to have a record of the product's serial number. Please take the time to enter that number in the space provided below. The serial number can be found on the bottom panel of the amplifier and on the amplifier packaging.

Serial Number:

## INSTALLATION APPLICATIONS

This amplifier is designed for operation in vessels with 12 volt, negative-ground electrical systems. Use of this product in vessels with positive ground and/or voltages other than 12V may result in damage to the product and will void the warranty.

This product is not certified or approved for use in aircraft.

Do not attempt to "bridge" the outputs of this amplifier with the outputs of a second amplifier, including an identical one.

## PLANNING YOUR INSTALLATION

It is important that you take the time to read this manual and that you plan out your installation carefully. The following are some considerations that you must take into account when planning your installation.

### Cooling Efficiency Considerations:

The outer shell of your JL Audio amplifier is designed to remove heat from the amplifier circuitry. For optimum cooling performance, this outer shell should be exposed to as large a volume of air as possible. Enclosing the amplifier in a small, poorly ventilated chamber can lead to excessive heat build-up and degraded performance. If an installation calls for an enclosure around the amplifier, we recommend that this enclosure be ventilated with the aid of a fan. In normal applications, fan-cooling is not necessary.

### ! IMPORTANT

Mounting the amplifier upside down is strongly discouraged.

### Safety Considerations:

Your amplifier needs to be installed in a dry, well-ventilated environment and in a manner which does not interfere with your vessel's factory installed electronic devices. You should also take the time to securely mount the amplifier using the supplied screws so that it does not come loose in the event of a collision or a sudden jolt to the vessel.

### Stupid Mistakes to Avoid:

- Check before drilling any holes in your vessel to make sure that you will not be drilling through the hull, a fuel tank, fuel line, wiring harness or other vital vessel system.
- Do not run system wiring outside or underneath the vessel. This is an extremely dangerous practice which can result in severe damage to your vessel and person.
- Protect all system wires from sharp edges (metal, fiberglass, etc.) by carefully routing them, tying them down and using grommets and loom where appropriate.
- Do not mount the amplifier in the engine compartment or in any other area that will expose the amplifier circuitry to the elements.

### ! IMPORTANT

While this amplifier is specially designed for marine applications, it is not waterproof and it should not be mounted where it is likely to get wet.

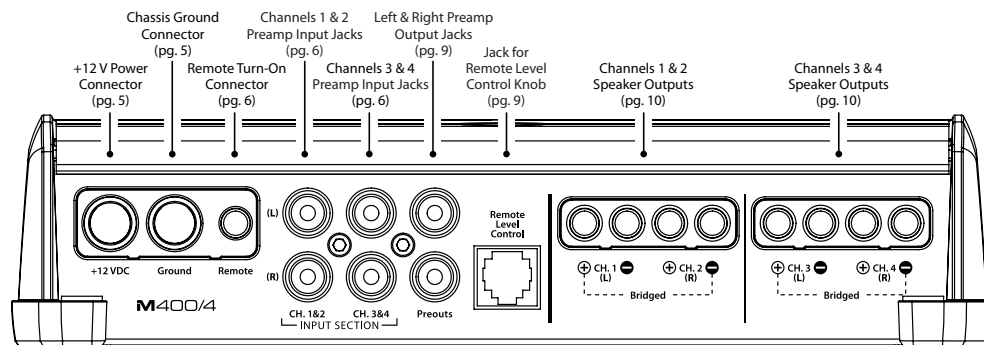
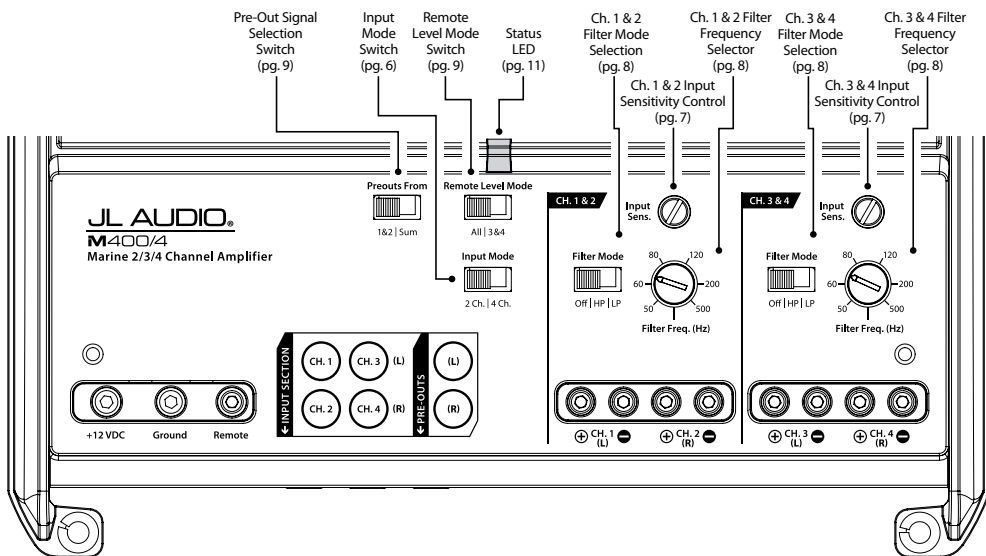

## PRODUCT DESCRIPTION

The JL Audio M400/4 is a four-channel, full-range audio amplifier utilizing JL Audio NexD™ ultra-high speed switching technology to deliver outstanding fidelity and efficiency.

The M400/4 can be operated with a wide variety of source units and system configurations.

## TYPICAL INSTALLATION SEQUENCE

The following represents the sequence for a typical amplifier installation, using an aftermarket source unit. Additional steps and different procedures may be required in some applications. If you have any questions, please contact your authorized JL Audio dealer for assistance.

- 1) Disconnect the negative battery post connection and secure the disconnected cable to prevent accidental re-connection during installation. **This step is not optional.**
- 2) Run 4 AWG power wire from the battery location to the amplifier mounting location, taking care to route it in such a way that it will not be damaged and will not interfere with vessel operation. Use 4 AWG or larger power wire and a power distribution block if additional amplifiers are being installed with the M600/4.
- 3) Connect power wire to the positive battery post. Fuse the wire with an appropriate fuse block (and connectors) within 18 inches (45 cm) wire length of the positive battery post. **This fuse is essential to protect the vessel. Do not install the fuse until the power wire has been securely connected to the amplifier.**
- 4) Connect negative power wire to the negative battery post. Use the same size power wire as the wire connected to the “+12V” connection (minimum 4 AWG).
- 5) Run signal cables and remote turn-on wire from the source unit to the amplifier mounting location.
- 6) Run speaker cable from the speaker systems to the amplifier mounting location.

- 7) Securely mount the amplifier.
- 8) Connect the positive and negative power wires to the amplifier. A fuse near the amplifier is not necessary if the M600/4 is the only device being run from the fused main power wire. If the fused main power wire is shared by the M600/4 and other amplifiers or devices, fuse each amplifier/device within 12 inches (30 cm) of wire length, via a fused distribution block or multiple individual fuse blocks/on-board fuses.
- 9) Connect the remote turn-on wire to the amplifier.
- 10) Connect the input cables to the amplifier.
- 11) Connect the speaker cables to the amplifier.
- 12) Carefully review the amplifier's control settings to make sure that they are set according to the needs of the system.
- 13) Install the power wire fuse (40A for a single M600/4) and reconnect the negative battery post terminal. Install the fuse (40A) near the amplifier (if applicable).
- 14) Turn on the source unit at a low level to double-check that the amplifier is configured correctly. Resist the temptation to crank it up until you have verified the control settings.
- 15) Make necessary adjustments to the input sensitivity controls to obtain the right overall output and the desired balance in the system. See Appendix A (page 14) for the recommended input sensitivity setting method.
- 16) Enjoy the fruits of your labor with your favorite music.

## POWER CONNECTIONS

Before installing the amplifier, disconnect the negative (ground) wire from the vessel's battery. This will prevent accidental damage to the system, the vessel and your body during installation.

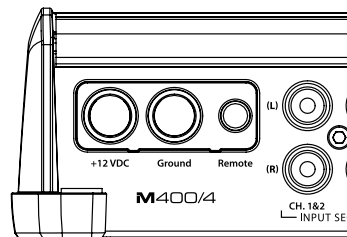

The M600/4's “+12 VDC” and “Ground” connections are designed to accept 4 AWG power wire. **4 AWG is the required wire size for this amplifier.**

If you are installing the M600/4 with other amplifiers and wish to use a single main power wire, use 2 AWG or 1/0 AWG main power wire (depending on the overall current demands of all the amplifiers in the system). This 2 AWG or 1/0 AWG power wire should terminate into a fused distribution block mounted as close to the amplifiers as possible (within 12 inches / 30cm of wire length). The fused output of the distribution block will connect to the M600/4 with 4 AWG power wire. JL Audio ECS fused distribution blocks are recommended (XD-FDBU-2 and XD-FDBU-4)

**Note:** Smaller AWG numbers mean bigger wire and vice-versa (1/0 AWG is the largest, 2 AWG is smaller, then 4 AWG, then 8 AWG, etc.).

To connect the power wires to the amplifier, first back out the set screw on the top of the terminal block, using the supplied 2.5 mm hex wrench. Strip 1/2 inch (12 mm) of insulation from the end of each wire and insert the bare wire into the terminal block, seating it firmly so that no bare wire is exposed. While holding the wire in place, tighten the set screw firmly, taking care not to strip the head of the screw.

The ground connection should be made using the same gauge wire as the power connection.

Any wires run through barriers must be protected with a high quality rubber grommet to prevent damage to the insulation of the wire. Failure to do so may result in a dangerous short circuit.

## ! IMPORTANT

**Many vessels employ small (10 AWG - 6 AWG) wire to connect the alternator's positive connection to the battery. To prevent voltage drops, this wire should be upgraded to 4 AWG when installing amplifier systems with main fuse ratings above 60A.**

It is common for the alternator to be grounded through its chassis. If the alternator is not grounded through its chassis and instead employs a small (10 AWG - 6 AWG) wire to connect to ground, this wire should also be upgraded to 4 AWG when installing amplifier systems with main fuse ratings above 60A.

## FUSE REQUIREMENTS

It is absolutely vital that the main power wire(s) to the amplifier(s) in the system be fused within 18 inches (45 cm) of the positive battery post connection. The fuse value at each power wire should be high enough for all of the equipment being run from that power wire. If only the M600/4 is being run from that power wire, we recommend a 40A fuse be used.

If fusing the amplifier near its power connections (when more than one amp is being run from the main power wire), use a 40A fuse.

MAXI™ (big plastic-body) fuses are recommended.

## TURN-ON LEAD

The M400/4 uses a conventional +12V remote turn-on lead, typically controlled by the source unit's remote turn-on output. The amplifier will turn on when +12V is present at its "Remote" input and turn off when +12V is switched off. If a source unit does not have a dedicated remote turn-on output, the amplifier's turn-on lead can be connected to +12V via a switch that derives power from an ignition-switched circuit.

The M400/4's "Remote" turn-on connector is designed to accept 18 AWG – 12 AWG wire. To connect the remote turn-on wire to the amplifier, first back out the set screw on the top of the terminal block, using the supplied 2.5mm hex wrench. Strip 1/2 inch (12mm) of wire and insert the bare wire into the terminal block, seating it firmly so that no bare wire is exposed. While holding the wire in the terminal, tighten the set screw firmly, taking care not to strip the head of the screw and making sure that the wire (not the insulation) is firmly gripped by the set screw.

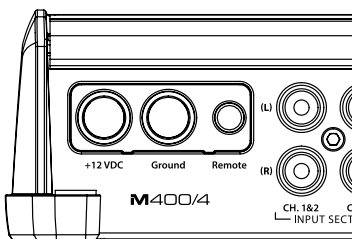

## INPUT SECTION

The M400/4's input section allows you to send signals to the amplifier section through the use of two or four differential-balanced inputs.

Input connections are via up to two pairs of traditional RCA-type jacks.

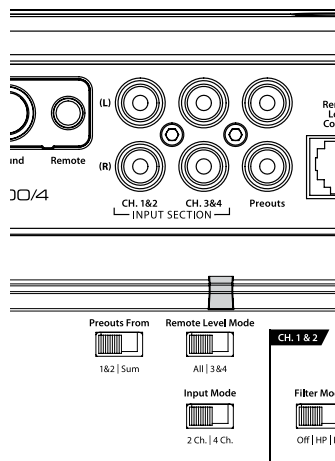

If you wish to send four discrete channels into the M400/4, simply use all four inputs and set the "Input Mode" switch in the "4 Ch." position.

If you wish to use only two channels of input to deliver signal to all four amplifier channels, set the "Input Mode" switch to "2 Ch." and use only the inputs to channels 1 & 2. In this mode, Channel 3 will operate with the Channel 1 signal and Channel 4 will operate with the Channel 2 signal.

### Input Voltage Range:

The M400/4's input sections are designed to accept signal voltages from 100mV – 4V. This will accommodate all preamp level signals and many speaker level signals.

To use speaker-level sources, simply splice the speaker output wires of the source unit onto a pair of RCA plugs for each input pair. (or use JL Audio part XD-CLRAIC2-SW) No "line output converter" is needed in most cases.

If you find that the output cannot be reduced sufficiently with a direct speaker level signal applied to the amplifier, you may use a "line output converter" to reduce the signal level.

## INPUT SENSITIVITY CONTROLS

The controls labeled "Input Sens." located in each channel section can be used to match the source unit's output voltage to the input stage of each pair of amplifier channels for maximum clean output. Rotating the control clockwise will result in higher sensitivity (louder for a given input voltage). Rotating the control counter-clockwise will result in lower sensitivity (quieter for a given input voltage.)

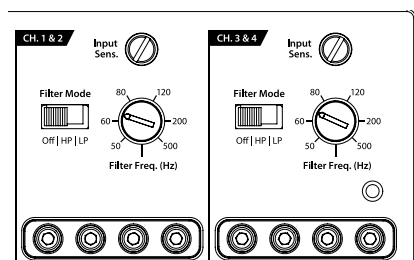

To properly set the amplifier for maximum clean output, please refer to Appendix A (page 14) in this manual. After using this procedure, you can then adjust any or all "Input Sens." levels downward if this is required to achieve the desired system balance.

**Do not increase any "Input Sens." setting for any channel(s) of any amplifier in the system beyond the maximum level established during the procedure outlined in Appendix A (page 14). Doing so will result in audible distortion and possible speaker damage.**

## FILTER CONTROLS

Most speakers are not designed to reproduce the full range of frequencies audible by the human ear. For this reason, most speaker systems are comprised of multiple speakers, each dedicated to reproducing a specific frequency range. Filters are used to select which frequency range is sent to each section of a speaker system. The division of frequency ranges to different speakers can be done with passive filters (coils and/or capacitors between the amplifier outputs and the speakers), which are acceptable and commonly used for filtering between mid-range speakers and tweeters. Filtering between subwoofer systems and satellite speaker systems is best done with active filters, which cut off frequency content at the input to the amplifier. Active filters are more stable than passive filters and do not introduce extraneous resistance, which can degrade subwoofer performance.

The active filter built into each channel section of the M400/4 can be used to eliminate potentially harmful and/or undesired frequencies from making their way through the amplifier sections to the speaker(s). This serves to improve tonal balance and to avoid distortion and possible speaker failure. Correct use of these filters can substantially increase the longevity and fidelity of your audio system.

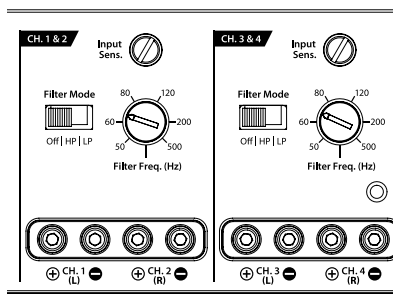

- 1) **“Filter Mode” Control:** The M400/4 employs a 12dB per octave filter for each pair of channels (one filter for channels 1&2, another filter for channels 3&4 and a third filter for channels 5&6). Each of these filters can be configured independently into one of two filter types

or defeated completely by way of the three-position **“Filter Mode”** switches:

**“Off”:** Defeats the filter completely, allowing the full range of frequencies present at the inputs to feed the amplifier. This is useful for systems utilizing outdoor active crossovers or requiring full-range reproduction from one or more of the M400/4’s channel pairs.

**“LP” (Low-Pass):** Configures the filter to attenuate frequencies above the selected filter frequency at a rate of 12dB per octave. This is useful for connection of subwoofer(s) to one or more of the M400/4’s channel pairs in a bi-amplified system.

**“HP” (High-Pass):** Configures the filter to attenuate frequencies below the selected filter frequency at a rate of 12dB per octave. This is useful for connection of component speakers to one or more of the M400/4’s channel pairs in a bi-amplified system.

- 2) **“Filter Freq. (Hz)”** The filter frequency markings surrounding this rotary control are for reference purposes and are generally accurate to within 1/3 octave or better. If you would like to select the filter cutoff frequency with a higher level of precision, consult the chart in Appendix B (page 15).

**Tuning Hint:** If you are using the M400/4 to drive a subwoofer system (**“LP” mode**), a component satellite speaker system (**“HP” mode**) or both, 80 Hz is a good baseline **“Filter Freq. (Hz)”** setting. After properly adjusting the **“Input Sens.”**, as outlined in Appendix A (page 14), you can fine tune the **“Filter Freq. (Hz)”** control to achieve the desired system frequency response.

## REMOTE LEVEL CONTROL (OPTIONAL)

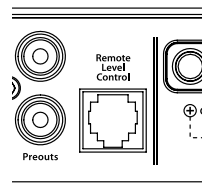

With the addition of the optional Remote Level Control (HD-RLC), you can control the volume of one, or both channel pairs of the M400/4 from a location of your choosing. This is useful for subwoofer level control, cabin speaker level control, zone volume control or even as a master volume control for the entire system.

The HD-RLC connects to the jack labeled **“Remote Level Control”** on the Connection Panel of the amplifier using a standard telephone cable (supplied with the HD-RLC). If desired, multiple XD (and HD) amplifiers can be controlled from a single HD-RLC controller using a simple phone line “splitter” and multiple phone cables.

When connected to the amplifier, the HD-RLC operates as follows. At full counter-clockwise rotation, the audio will mute completely. At full clockwise rotation the level will be the same as if the HD-RLC was not connected at all. In other words, it operates strictly as a level **attenuator**.

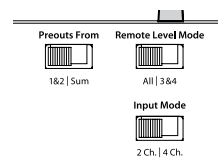

**“Remote Level Mode” Switch:** This switch allows you to assign the operation of the HD-RLC to one, or both pairs of channels. In the **“All”** position, the HD-RLC knob will affect all three channel pairs equally. In the **“3&4”** position, only the level of channels 3 and 4 will be affected by the HD-RLC knob (Channels 1 & 2 will not).

## PREOUTS

The M400/4 incorporates a pass-through preamp output section, so that additional amplifiers can be easily added to the system. This pass-through pre-amp output can be configured two different ways using the switch labeled **“Preouts From”**.

- 1) **“1&2”:** The preamp output delivers the same signal that is connected to the CH 1&2 Inputs. This mode is useful for feeding a subwoofer amplifier when the M400/4 is being used to drive front and rear speaker systems. In this mode, the preamp output signal will depend only on the input signal level of CH 1&2, allowing Channels 3&4 to be faded without affecting the subwoofer level. If CH 1&2 is faded in this mode, the signal level of the preamp output will change accordingly.
- 2) **“Sum”:** When the M400/4 is being used to drive front and rear speaker systems, this preamp output mode will deliver a summed front/rear stereo signal to a subwoofer amplifier, while permitting fading of the front and rear speaker systems from the source unit. This method prevents a loss of signal to the subwoofer amplifier when the system is faded to the front or the rear by the head unit.

**Note:** In either mode, the preamp output signal is not affected by any crossover filter selected (if the input signal is full-range, the preamp output will be full-range).

## SPEAKER OUTPUTS

The M400/4's speaker outputs are designed to accept 16 AWG - 8 AWG wire. To connect the speaker wires to the amplifier, first back out the set screws on the top of the terminal block, using the supplied 2.5 mm hex wrench. Strip 1/2 inch (12 mm) of insulation from the end of each wire and insert the bare wire into the terminal block, seating it firmly so that no bare wire is exposed. While holding the wire in place, tighten the set screw firmly, taking care not to strip the head of the screw.

Each pair of the M400/4's channels are designed to deliver power into speaker loads equal to or greater than 2 ohms when using a "stereo" configuration and speaker loads equal to or greater than 4 ohms when using a "bridged" configuration.

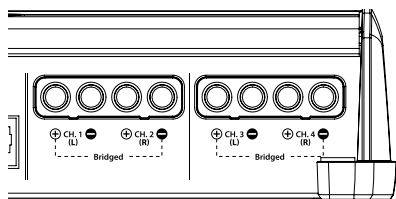

## ! IMPORTANT

**Speaker loads below 2 ohms nominal per channel (or 4 ohms bridged) are not recommended and may cause the amplifier to initiate a protection mode which reduces power output.**

## BRIDGING CONSIDERATIONS

Bridging is the practice of combining the output of two amplifier channels to drive a single load. When bridged, each channel produces signals of equal magnitude, but opposite polarity. The combined output of the two channels provides twice the output voltage available from a single channel. The M400/4 has been designed for bridging of its channel pairs without the need for input inversion adaptors.

To bridge a pair of channels, use the "Left +" and "Right -" speaker connectors only (the

"Left -" and "Right +" remain unused). When bridged, each channel will deliver optimum power into a 4 ohm load.

## ! IMPORTANT

**When a pair of channels are bridged, they will deliver 200W x 1 into a 4 ohm load or 150W x 1 into an 8 ohm load. Operating a pair of bridged channels into a load lower than 4 ohms is not recommended. Because a bridged pair of channels requires that both channels receive input, you need to connect both left and right inputs to the source unit. Connection of only one input will result in reduced power output, increased distortion and can cause the amplifier to overheat. Do not do this!**

When a pair of the M400/4's channels are operating in bridged mode, the output will be in mono (only one channel). This mono channel can contain right channel only information, left channel only information or the sum of the information from both the right and left channels. In order to achieve one of these options, configure the inputs to that pair of channels in one of these two ways:

### 1) Left Channel Only or Right Channel Only

**Information:** If you wish to send a left-only or right-only signal to a pair of the M400/4's channels, use a "Y-Adaptor" to split the single channel signal into both left and right RCA inputs. This option is useful when using a pair of the M400/4's channels to drive left channel speakers only and the other pair of the M400/4's channels to drive right channel speakers only.

### 2) Left + Right Channel Information:

When bridged and fed by a stereo input, a pair of the M400/4's channels will automatically combine the left and right channels into a summed mono (left + right) channel. This option is useful when using a pair of the M400/4's channels to drive a subwoofer system or a summed mono center channel.

## STATUS LED / PROTECTION CIRCUITRY

There is a single multi-color LED on the top surface of the amplifier to indicate the amplifier's operating status.

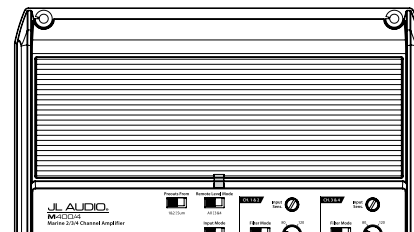

**1) Flashing Green:** amplifier is powering up, audio output is muted.

**2) Constant Green:** amplifier is on and functioning normally, audio output is active.

**3) Constant Red:** Indicates that the amplifier has exceeded its safe operating temperature, putting the amplifier into a self-protection mode, which reduces the peak power output of the amplifier. When its temperature returns to a safe level, the red light will return to green and the amplifier will return to full-power operating mode.

**4) Constant Amber (yellow):** Indicates that an over-current condition has occurred and is accompanied by a muting of the affected channel(s). Because the muting behavior may be very short in duration, it may manifest itself as an audible, repetitive ticking noise in the output. Over-current conditions can be caused by a speaker impedance lower than the optimum load impedance range for the amplifier or a short-circuit in the speaker wiring. The latter can result from a short circuit between the positive and negative speaker wires or between either speaker wire and a power wire. The "Status LED" will remain amber for a few seconds, even if the over-current condition is of a very short duration. This functionality can be used to diagnose a short-circuit by only connecting one channel at a time. The "Status LED" will turn amber when you connect the channel that is experiencing the problem and turn the volume up.

### 5) LED off / Amplifier Shuts Off Unexpectedly

The only condition that will shut down an undamaged M600/6 completely is if battery voltage or remote turn-on voltage drops below 10 volts. The "Status LED" will turn off when this occurs. The amplifier will turn back on when voltage climbs back above 11 volts. If this is happening in your system, have your charging system and power wiring inspected.

For more information on troubleshooting this amplifier, refer to Appendix D (pages 16, 17).

## SERVICING YOUR JL AUDIO AMPLIFIER

If your amplifier fails or malfunctions, please return it to your authorized JL Audio dealer so that it may be sent in to JL Audio for service. There are no user serviceable parts or fuses inside the amplifier. The unique nature of the circuitry in the JL Audio amplifiers requires specifically trained service personnel. Do not attempt to service the amplifier yourself or through unauthorized repair facilities. This will not void the warranty, but may result in the creation of more problems within the amplifier.

If you have any questions about the installation or setup of the amplifier not covered in this manual, please contact your dealer or technical support.

### JL Audio Technical Support:

(954) 443-1100  
9:00 AM – 5:30 PM (Eastern Time Zone)  
Monday - Friday

## SYSTEM CONFIGURATIONS

The M400/4 is a flexible amplifier, well-suited for a multitude of system configurations. In this section, the most likely configurations for a system with a single M400/4 are explained in detail.

Once you have selected your desired configuration, you can use the amplifier panel drawing on pages 18 & 19 to mark the required switch positions for easy reference.

### BI-AMPLIFIED SYSTEMS

Bi-amplified systems are defined as systems in which separate amplifier channels drive low-frequency (LF) and high-frequency (HF) speakers and are separately filtered to send appropriate frequency ranges to each speaker system.

The most common application of bi-amplification in marine audio is to drive a subwoofer system from one or more amplifiers or channels and component speakers from separate amplifiers or channels.

The M400/4 can be configured to drive a bi-amplified system by itself or with a separate subwoofer amplifier.

#### Bi-Amplified System with one M400/4

In this configuration, channels 3&4 of the M400/4 will drive subwoofers (stereo or bridged) with low-pass filtering. Channels 1&2 will drive component speakers in stereo with high-pass filtering.

*Input connection options for a bi-amplified system with one M400/4 are as follows:*

##### A) No User Adjustability:

**Required:** a basic source unit or processor with one pair of stereo outputs.

**Input Connections:** a single pair of stereo source unit outputs connected to the “CH 1 (Left)” and “CH 2 (Right)” inputs of the M400/4 (select “2 Ch.” on the “Input Mode” switch).

**Result:** the relative level of the LF and HF channels will be determined by the M400/4’s “Input Sens.” settings and will not be user adjustable from the helm.

##### B) Fade Subwoofer Level vs. HF Level

**Required:** a source unit or processor with two pairs of stereo outputs.

**Input Connections:** the first stereo pair of source unit outputs is connected to the “CH 1 (Left)” and “CH 2 (Right)” inputs of the M400/4.

The second stereo pair of source unit outputs is connected to the “CH 3 (Left)” and “CH 4 (Right)” inputs (select “4 Ch.” on the “Input Mode” switch).

**Result:** in this mode, the user has the ability to fade or control the level of the LF channels relative to the HF channels via the source unit’s fader control without exceeding the maximum clean output level set by each amplifier section’s “Input Sens.” controls.

##### C) Subwoofer Level Control Only:

**Required:** a source unit or processor with one pair of stereo outputs and dedicated subwoofer outputs.

**Input Connections:** the main stereo pair of source unit outputs is connected to the “CH 1 (Left)” and “CH 2 (Right)” inputs of the M400/4. The source unit’s dedicated subwoofer output is connected to the “CH 3 (Left)” and “CH 4 (Right)” inputs (select “4 Ch.” on the “Input Mode” switch).

**Result:** in this mode, the user has the ability to control the absolute level of the LF channels relative to the HF channels.

### ! IMPORTANT

Set the “Input Sens.” in the “Channel 3 & 4 Controls” section with the source unit’s subwoofer level control set at 3/4 of full output. See Appendix A (page 14) for details.

#### Crossover Setup for Bi-Amplified System with one M400/4:

Once the input sections have been configured appropriately, go to the “Channel 3 & 4 Controls”. Select “LP” (low-pass) on the “Filter Mode” switch and an appropriate “Filter Freq.” (80 Hz is a good starting point).

Next, turn your attention to the “Channel 1 & 2 Controls” and select “HP” (high-pass) on the “Filter Mode” switch and an appropriate “Filter Freq.” (again, 80 Hz is a good starting point).

After proper adjustment of the “Input Sens.” controls for both channel pairs using the method shown in Appendix A (page

14), you can fine tune filter frequencies and attenuate either pair of channels to achieve proper balance. For precise filter frequency information refer to Appendix B (page 15).

### MULTI-AMPLIFIER SYSTEMS

Using the “Preamp Outputs” of the M400/4, it is easy to configure many different multi-amplifier systems.

The most common type involves the addition of a subwoofer amplifier, such as the M600/1. Common configurations of such a system are described below.

#### Bi-Amplified System with one M400/4 in four-channel mode and a separate subwoofer amplifier

This configuration requires that the separate subwoofer amplifier has a built-in low-pass filter. (All JL Audio amplifiers have this feature.) In this configuration, channels 1&2 of the M400/4 will drive front component speakers in stereo with high-pass filtering. Channels 3&4 will drive rear component speakers in stereo, also with high-pass filtering. The separate amplifier will drive the subwoofer system with low-pass filtering (80 Hz is a good starting point).

*Here are three possible configuration options:*

##### A) Fade Subwoofer Level vs. HF Level:

**Required:** a source unit or processor with front and rear pairs of stereo outputs.

**Input Connections:** one stereo pair of source unit outputs is connected to the “CH 1 (Left)” and “CH 2 (Right)” inputs of the M400/4 (select “2 Ch.” on the “Input Mode” switch). The second stereo pair of source unit outputs is connected to the subwoofer amplifier inputs.

**Result:** with this option, the user has the ability to fade the level of the subwoofer amplifier’s input relative to the HF channels, but cannot control front-to-rear fading of the HF channels. The relative level of the front and rear HF channels will be fixed by the M400/4’s “Input Sens.” settings and will not be user adjustable from the front of the vessel.

##### B) Subwoofer Level Control Only:

**Required:** a source unit or processor with left, right and dedicated subwoofer outputs.

**Input Connections:** The main stereo pair of source unit outputs is connected to the “CH 1 (Left)” and “CH 2 (Right)” inputs of the M400/4 (select “2 Ch.” on the “Input Mode” switch). The source unit’s dedicated subwoofer output is connected to the subwoofer amplifier inputs.

**Result:** with this option, the user has the ability to control the absolute level of the subwoofer channel relative to the HF channels, but cannot fade the front and rear HF channels relative to each other.

### ! IMPORTANT

Set the subwoofer amplifier’s “Input Sens.” with the source unit’s subwoofer level control set at 3/4 of full output.

##### C) Front to Rear HF Fading and Subwoofer Level Control:

**Required:** a source unit or processor with front and rear pairs of stereo outputs plus a dedicated subwoofer output.

**Input Connections:** one stereo pair of source unit outputs is connected to the “CH 1 (Left)” and “CH 2 (Right)” inputs of the M400/4. The second stereo pair of source unit outputs is connected to the “CH 3 (Left)” and “CH 4 (Right)” inputs of the M400/4 (select “4 Ch.” on the “Input Mode” switch). The source unit’s dedicated subwoofer output is connected to the subwoofer amplifier inputs.



## APPENDIX A:

### Input Sensitivity Level Setting

Following the directions below will allow the installer to adjust the input sensitivity of each amplifier channel pair simply and easily in just a few minutes using equipment which is commonly available.

#### Necessary Equipment

- Digital AC Voltmeter
- CD with a sine-wave test tone recorded at 0 dB reference level in the frequency range to be amplified for that set of channels (50 Hz for subwoofer channels, 1 kHz for a midrange application). Do not use attenuated test tones (-10 dB, -20 dB, etc.).

#### The Nine-Step Procedure

- 1) Disconnect the speaker(s) from the amplifier's speaker output connectors.
- 2) Turn off all processing (bass/treble, loudness, EQ, etc.) on the source unit, processors (if used) and amplifier. Set fader control to center position and subwoofer level control to 3/4 of maximum (if used to feed the M400/4).
- 3) Turn both "Input Sens." controls all the way down.
- 4) Set the source unit volume to 3/4 of full volume. This will allow for reasonable gain overlap with moderate clipping at full volume.
- 5) Using the chart on this page, determine the target voltage for input sensitivity adjustment according to the nominal impedance of the speaker system connected to the amplifier outputs.
- 6) Verify that you have disconnected the speakers before proceeding. Play a track with an appropriate sine wave (within the frequency range to be amplified by the M400/4) at 3/4 source unit volume.
- 7) Connect the AC voltmeter to the speaker output connectors of the amplifier. If the channel pair is operating in stereo, it is only necessary to measure one channel. If bridged, make sure you test the voltage at the correct connectors (L+ and R-).
- 8) Increase the "Input Sens." control until the target voltage is observed with the voltmeter.

- 9) Once you have adjusted the M400/4 to its maximum low-distortion output level, reconnect the speaker(s). The "Input Sens." controls can now be adjusted downward if the amplifier requires attenuation to achieve the desired system balance.

### ! IMPORTANT

**Do not increase any "Input Sens." setting for any amplifier channel or channel pair in the system beyond the maximum level established during this procedure. Doing so will result in audible distortion and possible speaker damage.**

It will be necessary to re-adjust the "Input Sens." for the affected channels if any equalizer boost is activated after setting the "Input Sens." with this procedure. This applies to any EQ boost circuit, including source unit tone controls or EQ circuits. EQ cuts will not require re-adjustment.

Nom. Impedance	Target AC Voltage	
	Stereo	Bridged
8Ω	17.4 V	34.8 V
6Ω	17.4 V	32.8 V
4Ω	17.4 V	28.2 V
3Ω	16.4 V	not recommended
2Ω	14.1 V	not recommended

## APPENDIX B:

### Precise Frequency Selection Chart

Detent Number	"FILTER FREQ" Panel Marking	Actual Freq.
<b>Full counter-clockwise: 49</b>		
01		.49
02	"50"	.49
03		.50
04		.50
05		.52
06		.53
07		.55
08	"60"	.57
09		.59
10		.61
11		.63
12		.65
13		.68
14		.70
15		.73
16	"80"	.76
17		.79
18		.83
19		.86
20	"12 o'clock"	.90
21		.95
22		1.00
23		1.05
24	"120"	1.11
25		1.18
26		1.26
27		1.35
28		1.46
29		1.60
30		1.74
31		1.92
32	"200"	2.17
33		2.43
34		2.86
35		3.39
36		4.06
37		4.44
38	"500"	4.82
39		4.83
<b>Full-clockwise: 483</b>		

## APPENDIX C:

### M400/4 Specifications

#### General Specifications:

Recommended Fuse Value: 40A

Recommended Fuse Type: MAXI® or AGU

#### Input Sections:

No. of Inputs: Two Stereo Pairs

Input Type: Differential-balanced with RCA jack inputs

Input Range: 100mV - 4V RMS

#### Amplifier Section:

Amplifier Topology: NexD™ Ultra-High Speed Class D

Power Supply: Unregulated MOSFET switching type

**Rated Power at 14.4V with less than**

**1% THD+Noise (20Hz - 20 kHz)**

Stereo, all channels driven:

75W RMS x 4 @ 4 ohms, 100W RMS x 4 @ 2 ohms

Bridged, all channels driven:

150W RMS x 2 @ 8 ohms, 200W RMS x 2 @ 4 ohms

**Rated Power @ 12.5V with less than**

**1% THD + Noise (20Hz - 20 kHz)**

Stereo, all channels driven:

60W RMS x 4 @ 4 ohms, 90W RMS x 4 @ 2 ohms

**Rated Power Bridged, all channels driven:**

120W RMS x 2 @ 8 ohms, 180W RMS x 2 @ 4 ohms

**Signal to Noise Ratio:**

>104 dB referred to rated power

(A-weighted, 20 Hz-20 kHz noise bandwidth)

>84 dB referred to 1W

(A-weighted, 20 Hz-20 kHz noise bandwidth)

**Frequency Response:** 12 Hz - 22 kHz (+0, -1dB)

**Damping Factor:**

>150 @ 4 ohms per ch./ 50 Hz

>75 @ 2 ohms per ch. / 50 Hz

#### Crossover Filters:

**Filter Type:** State-variable, 12dB/octave Butterworth with continuously variable cutoff frequency selection from 50-500 Hz.

Configurable as Low-Pass or High-Pass. Defeatable.

#### Dimensions (LxWxH):

8.52" x 7.09" x 2.05" (217mm x 180mm x 52mm)

Due to ongoing product development, all specifications are subject to change without notice.



## APPENDIX D: TROUBLESHOOTING

### “How do I properly set the input sensitivity on my amplifier?”

Please refer to Appendix A (page 14) to set the input sensitivity for maximum, low-distortion output.

### “My amplifier doesn’t turn on.”

**Check** the fuse, not just visually, but with a continuity meter. It is possible for a fuse to have poor internal connections that cannot be found by visual inspection. It is best to take the fuse out of the holder for testing. If no problem is found with the fuse, inspect the fuse-holder.

**Check** the integrity of the connections made to each of the “+12VDC”, “Ground”, and “Remote” terminals. Ensure that no wire insulation is pinched by the terminal set screw and that each connection is tight.

**Check** to make sure there is +12V at the “Remote” connection of the amplifier. In some cases, the turn-on lead from the source unit is insufficient to turn on multiple devices and the use of a relay is required. To test for this problem, jump the “+12VDC” wire to the “Remote” terminal to see if the amplifier turns on.

### “I hear a repetitive ticking or popping sound coming out of the speaker(s).”

**Check** the speaker wires for a possible short, either between the positive and negative leads or between either speaker lead and the vessel’s electrical ground. If a short is present, you will experience distorted and/or attenuated output. The “Status LED” will turn Amber (yellow) in this situation. It may be helpful to disconnect the speaker wires from the amplifier and use a different set of wires connected to a test speaker.

**Check** the nominal load impedance to verify that each channel of the amplifier is driving a load equal to or greater than 2 ohms in stereo mode (4 ohms bridged).

### “My amplifier’s output fluctuates when I tap on it or hit a bump.”

**Check** the connections to the amplifier. Make sure that the insulation for all wires has been stripped back far enough to allow a good contact area inside the terminal block.

**Check** the input connectors to ensure that they all are making good contact with the input jacks on the amplifier.

### “My amplifier shuts off once in a while, usually at higher volumes.”

**Check** your voltage source and grounding point. The power supply of the M400/4 will operate with charging system voltages down to 10V. Shutdown problems at higher volume levels can occur when the charging system voltage (or remote turn-on voltage) momentarily drops below 10V. These dips can be of very short duration making them extremely difficult to detect with a common DC voltmeter. To ensure proper voltage, inspect all wiring and termination points. It may also be necessary to upgrade the ground wire connecting the battery to the vessel’s electrical ground and the power wire connecting the alternator to the battery. Many vessels employ small (10 AWG - 6 AWG) wire to ground the battery and to connect the alternator to the battery. To prevent voltage drops, these wires should be upgraded to 4 AWG when installing amplifier systems with main fuse ratings above 60A. Grounding problems are the leading cause of misdiagnosed amplifier “failures.”

### “My amplifier turns on, but there is no output.”

**Check** the input signal using an AC voltmeter to measure the voltage from the source unit while an appropriate test tone is played through the source unit (disconnect the input cables from the amplifier prior to this test). The frequency used should be in the range that is to be amplified by the amplifier (example: 50 Hz for a sub bass application or 1 kHz for a full range / high-pass application). A steady, sufficient voltage (between 0.1 and 4.0-volts) should be present at the output of the signal cables.

**Check** the output of the amplifier. Using the procedure explained in the previous check item (after plugging the input cables back into the amplifier) test for output at the speaker outputs of the amplifier. Remove the speaker wires from the amplifier while doing this to prevent unpleasant noise and possible speaker damage. Turn the volume up approximately half way. 5V AC or more should be measured at the speaker outputs. This output level can vary greatly between amplifiers but it should not be in the millivolt range with the source unit at half volume. If you are reading sufficient voltage, check your speaker connections as explained below.

**Check** to ensure that the speaker wires are making a good connection with the metal inside the terminal block. The speaker wire connectors are designed to accept up to 8 AWG wire. Make sure to strip the wire to allow for a sufficient connection with the metal inside the terminal block.

**INSTALLATION NOTES:**

Use this diagram to document your amplifier's switch and control positions.

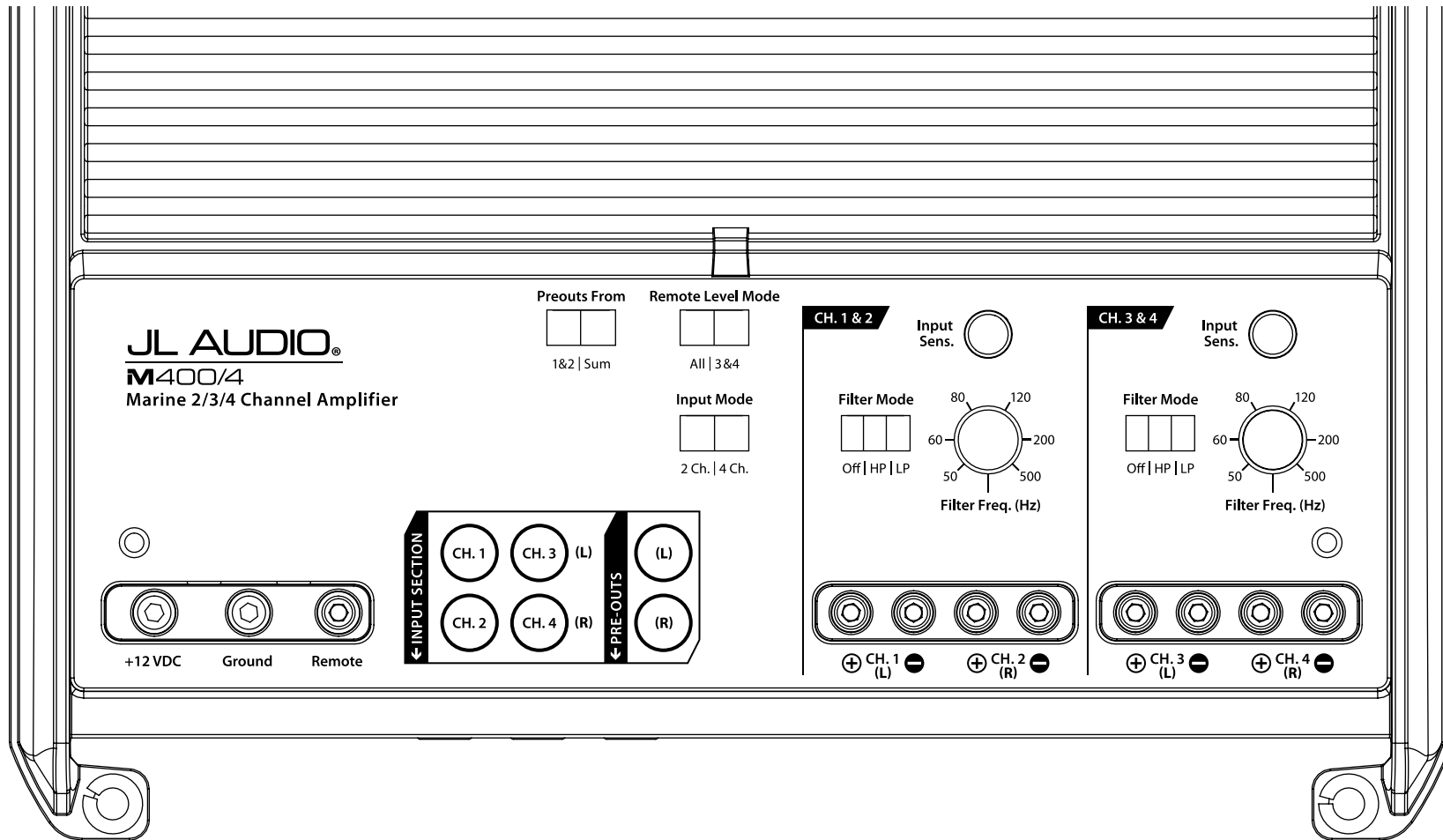

**LIMITED WARRANTY - AMPLIFIERS (USA)**

JL AUDIO warrants this product to be free of defects in materials and workmanship for a period of two (2) years.

This warranty is not transferable and applies only to the original purchaser from an authorized JL AUDIO dealer. Should service be necessary under this warranty for any reason due to manufacturing defect or malfunction, JL AUDIO will (at its discretion), repair or replace the defective product with new or remanufactured product at no charge. Damage caused by the following is not covered under warranty: accident, water intrusion, misuse, abuse, product modification or neglect, failure to follow installation instructions, unauthorized repair attempts, misrepresentations by the seller. This warranty does not cover incidental or consequential damages and does not cover the cost of removing or reinstalling the unit(s). Cosmetic damage due to accident or normal wear and tear is not covered under warranty.

**Warranty is void if the product's serial number has been removed or defaced.**

Any applicable implied warranties are limited in duration to the period of the express warranty as provided herein beginning with the date of the original purchase at retail, and no warranties, whether express or implied, shall apply to this product thereafter. Some states do not allow limitations on implied warranties, therefore these exclusions may not apply to you. This warranty gives you specific legal rights, and you may also have other rights which vary from state to state.

**If you need service on your JL AUDIO product:**

All warranty returns should be sent to JL AUDIO 's Amplifier Service Facility freight-prepaid through an authorized JL AUDIO dealer and must be accompanied by proof of purchase (a copy of the original sales receipt). Direct returns from consumers or non-authorized dealers will be refused unless specifically authorized by JL AUDIO with a valid return authorization number.

Warranty expiration on products returned without proof of purchase will be determined from the manufacturing date code. Coverage may be invalidated as this date is previous to purchase date. Non-defective items received will be returned freight-collect. Customer is responsible for shipping charges and insurance in sending the product to JL AUDIO. Freight damage on returns is not covered under warranty.

**For Service Information in the U.S.A. please call**

**JL Audio Customer Service:** (954) 443-1100

9:00 AM – 5:30 PM (Eastern Time Zone)

**JL Audio, Inc**

10369 North Commerce Pkwy.

Miramar, FL 33025

(do not send product for repair to this address)

**International Warranties:**

Products purchased outside the United States of America are covered only by that country's distributor and not by JL Audio, Inc.