

MCS-22C/MCS-22B  
poweracoustik.com

### III. Bluetooth Operation

Bluetooth Pairing Method:

- 1) After it is powered on, double click the MOD key to enter the Bluetooth mode, when the host is not connected to Bluetooth, the blue light at the speaker of the host and the auxiliary engine flashes; when it is connected to Bluetooth, the blue light at the speaker of the host and the auxiliary engine does not flash.
- 2) After entering the Bluetooth mode, the host will issue a "Ding Long dong" warning tone, first open the Bluetooth of the phone; then use the phone to search this local device, (name: POWER ACOUSTIK ) and for pairing connection.
- 3) The initial password of pairing is default to be "0000", after the pairing is successful, the host will issue a "ding dong ~ ding dong" prompt tone; at this time, open your mobile music player, the Bluetooth playback can be realized. Note: Some phones do not need to enter the pairing password; it will automatically conduct Bluetooth connection after the host is searched.

### IV. Installation Diagram

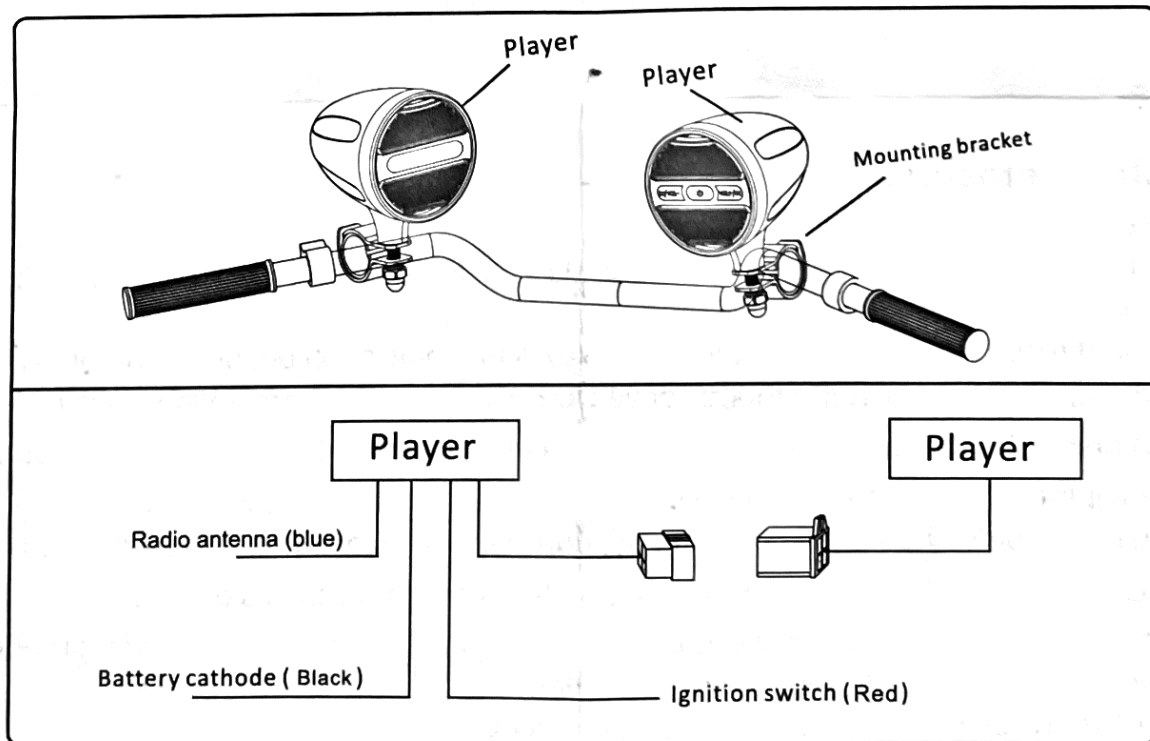

### V. Technical Parameters

FM

Frequency range: 87.5~108MHz

Intermediate frequency: 10.7MHz

SNR: 40dB

Noise sensitivity:  $\leq 37$ dB

Player

SNR: 40dB

Channel isolation (at 1 KHz): 23dB

Harmonic distortion (at 1 KHz):  $\leq 5\%$

Frequency response: 100Hz~10KHz $\pm 6$ dB

Power amplifier

Output: Speaker output

Speaker impedance: 4~8 $\Omega$

Maximum active output power: 15W $\times 2$

Maximum output power: 20W $\times 2$

Power supply: DC12V

MCS-22C/MCS-22B  
poweracoustik.com

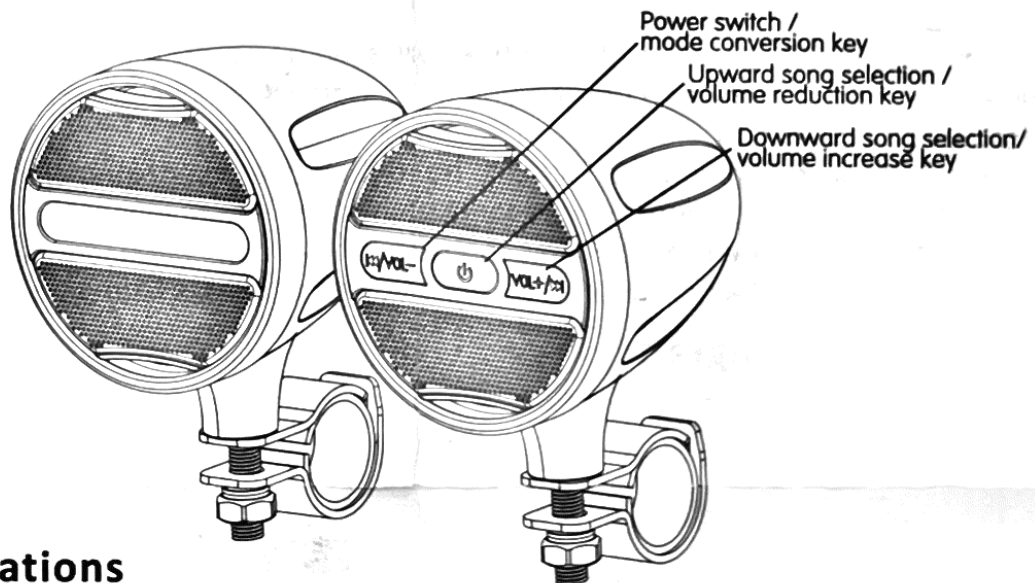

To achieve the optimal performance of the player, please read this manual carefully and install the player properly. Please keep this manual for future reference.

### I. Control Panel





### II. Basic Operations



#### 1. Power switch / mode conversion key ( )

1) After it is powered on, short press "  " key to start up; long press "  " key to power off, double click "  " for mode conversion.



2) In the boot reception mode, short press "  " key is the mute function, and short press again is relief of mute, double-click is the mode conversion, with sequential circulating conversion of "radio -U disk -BT" . When the related device is not connected to the host, the corresponding default equipment mode does not participate in the circulation. In the playback status of Bluetooth and U disk, short press is the Pause, and short press again is relief of the Pause, double-click is the mode conversion, with sequential circulating conversion of "radio -U disk -BT" . When the relevant equipment is not connected to the host, the corresponding mode of default device does not participate in the circulation.

#### 2. Upward song selection / volume reduction key( /VOL- )

1) In reception status, short press "  /VOL- "key is low frequency channel search, long press "  /VOL- "key is to reduce the volume.

2) In playing status of BT/U disk, short press "  /VOL- "key to select the previous song; long press "  /VOL- "key is to reduce the volume.

#### 3. Downward song selection/volume increase key( VOL+ )

1) In reception status, short press " VOL+  "is high-end frequency channel search; long press " VOL+  "key is to increase the volume.

2) In playing status of BT/U disk, short press " VOL+  "key is to select the next song; long press " VOL+  "key is to increase the volume.

**POWER ACOUSTIK**

**MCS-22B / MCS-22C**

**Caution: +12V DC Negative Ground**

**Receiving Range: FM 87.5~107.9MHz**

**Installation:**

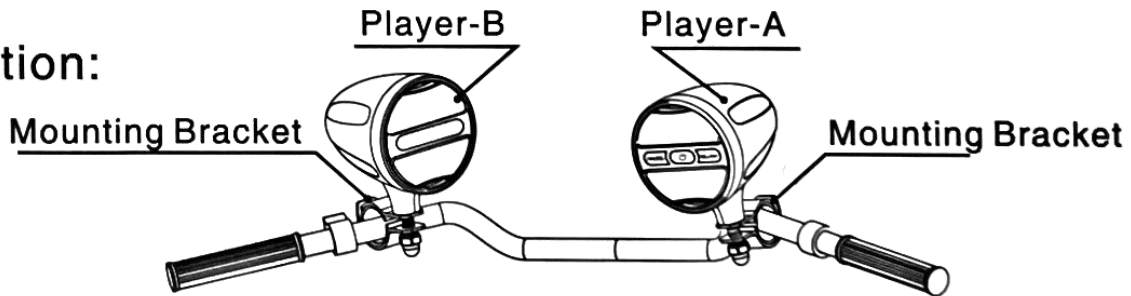

**Connection:**

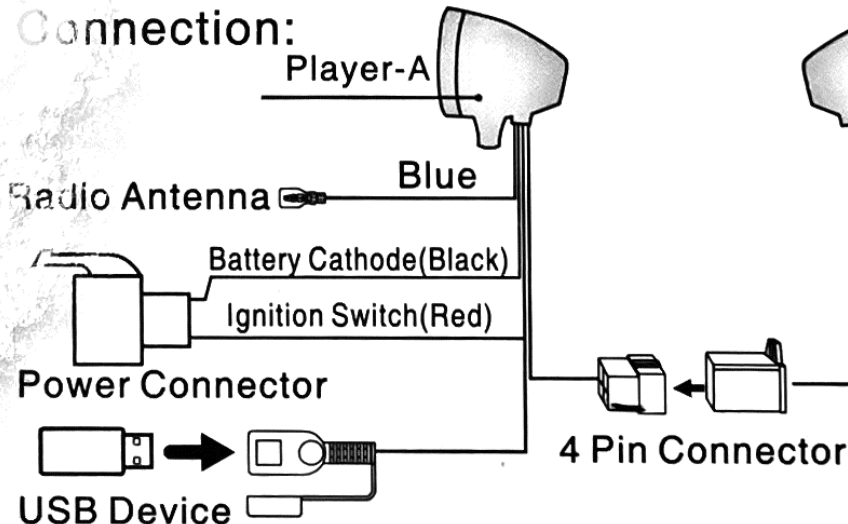

This equipment complies with Part 15 of the FCC Rules. Operation is subject to the following two conditions:

- 1). This device may not cause harmful interference.
- 2). This device must accept any interference receive including interference that may cause undesired operation.



**Serial No.: MCS-22C**