

Instruction Manual

POWER ACOUSTIK

MWT-80BL

FEATURES

8" MARINE GRADE WAKE TOWER SPEAKER w/RGB COLOR CHANGING LEDs

100% Waterproof Enclosure and Speaker System
High Density ABS Construction w/ UV Coating
Steel reinforced Mounting Bracket fits most towers
With New Swivel Mounting System
Braided Stainless Steel Safety Cable Included
Stainless Steel Mounting Hardware Included
Injection speaker cone and Titanium Tweeter
Meets ROHS and CE Certifications

Full function remote controls LED function
Multi-color LEDs(blue,red,green,yellow,pink,
purple and white) with 20 static colors
22 Dynamic modes
4-ohm System Impedance
850w MAX Power Handling
425w RMS Power Handling
Frequency Response:30-20kHz
System Efficiency:91dB(1w/1m)
Dimensions:10"w x 10"h x9.6"d

Mounting Bracket

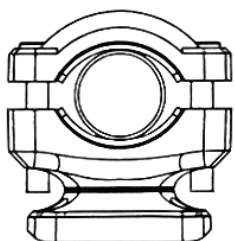
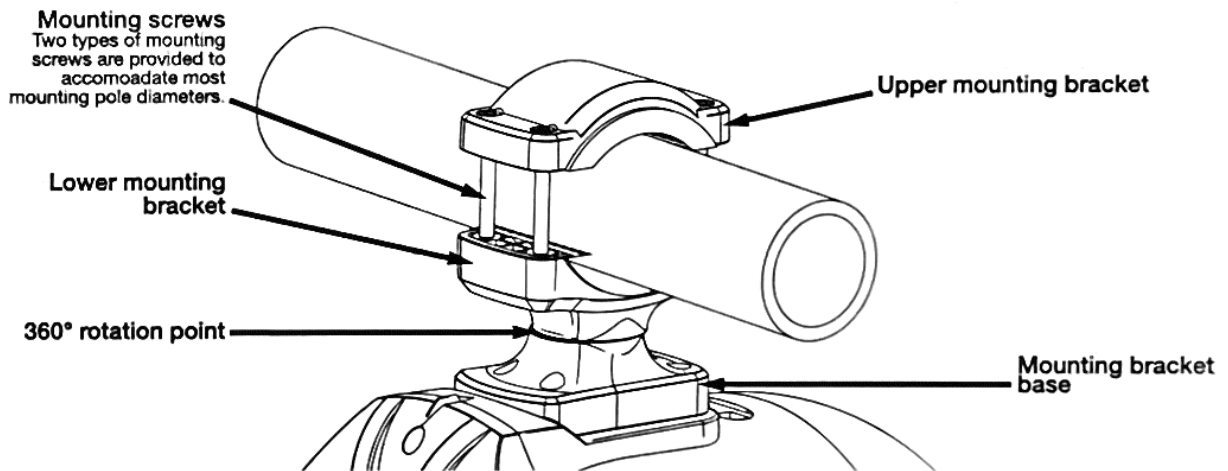

Min: 1.26in/32mm

For diameters ranging from 1.26 to 2.25 inches, use the 65mm screws.

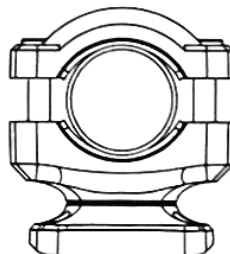

Max: 2.25in/57.15mm

360° Rotation Function

1. Loosen the rotation adjustment screw.

2. Rotate the lower mounting bracket to the desired position.

3. Lock the rotation adjustment screw.

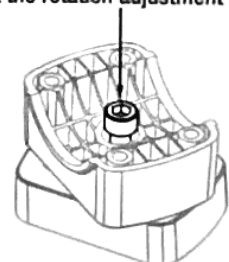
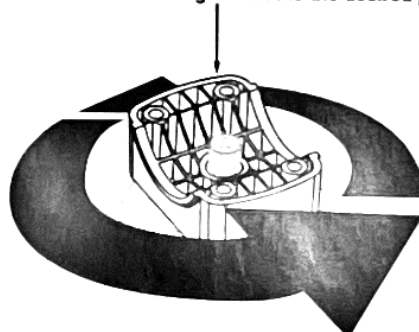
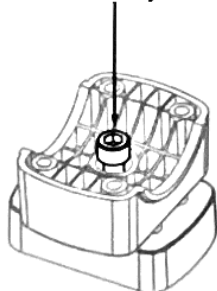

Instruction Manual

POWER ACOUSTIK

MWT-80BL

REMOTE CONTROL FEATURES

1. **Turn On/ Standby:** Press this key to turn on unit or switch to stand by mode. At poweron, unit will automaticly turn on and restore to previous status.
- 2/9. **Dynamic Mode Adjust:** Switch to dynamic mode from static color, or switch between dynamic modes.
- 3/10. **Dynamic Speed Adjust:** Adjust dynamic playing speed Press SPEED+ to increase speed and press SPEED- to decrease Unit will switch to dynamicmode If press this key at static color mode.
- 4/5. **Static Color Adjust:** Switch to static color mode from dynamic mode, or switch between static colors.
6. **Direct Color Select:** Shortcut key to static colors. When press the specific color key, LED will play the same static color. The direct colors are included in 'COLOR+' and 'COLOR-' operation.
- 7/8. **Brightness Adjust:** Adjust static color brightness. Press BRIGHT+ to increase brightness and press BRIGHT- to decrease Unit will switch to static color mode If press this key at dynamic mode.
11. **Demo Mode:** Press this key will switch to Demo mode. At demo mode, it plays 17 dynamic modes in loop, each mode repeat 3 times.

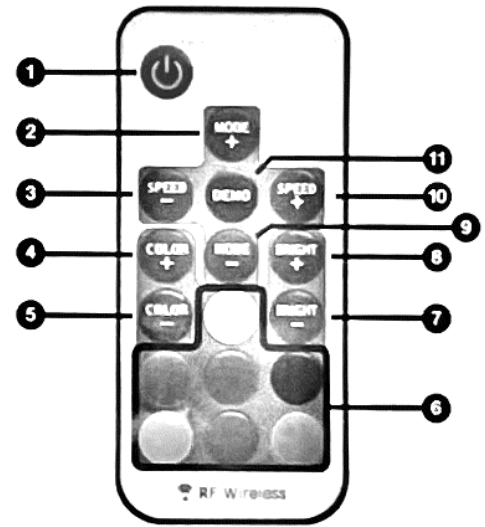

- 22 Dynamic Modes
- Card Type RF Remote
- 20 Static Colors
- Ultra Slim Design
- Very Smooth Effects
- Dynamic Demo Mode
- Speed Adjustable
- Easy Remote Pairing
- Brightness Adjustable
- Direct Color Select

Installation Guide

1. Speaker power +(red)
2. Speaker power -(black)
3. LED power +(white)-DC12V
4. LED power -(blue)-DC12V
5. LED power connect

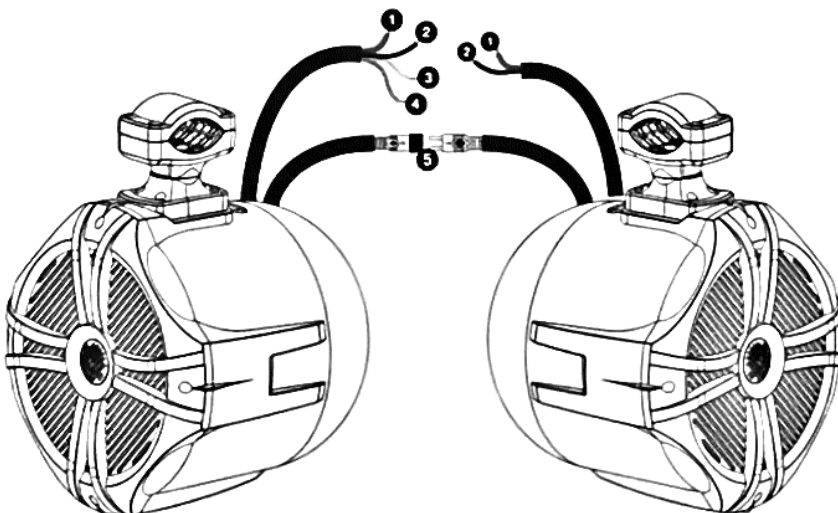

Assembly

