

POWER ACOUSTIK

2 Din Car AM/FM Radio, CD/MP3 Player
with USB/SD Card Inputs

Model No.:PCD-52B



USER'S MANUAL

CONTENTS

Precautions.....	1
How to Handle Discs.....	1
Precautions & Warnings.....	1
Lithium Battery Cell Warnings.....	1
Drivers and Connections.....	1
Other Warnings.....	1
Installation.....	2
Installation Procedures.....	2
Important.....	2
To Install the Car Radio.....	2
Wiring Connections.....	3
Control Panel Button Locations.....	4
General Operation.....	5
Turn Unit On/Off.....	5
Adjust Volume (VOL).....	5
Adjust Menu Options (SEL).....	5
Set the Clock (CLK).....	6
Change the Source (MODE).....	6
Mute on/off.....	6
Loudness on/off.....	6
Preset EQ(Equalizer).....	6
USB Port.....	6
Micro SD Card Slot.....	6
Built-in Microphone.....	6
AUX input Connector.....	6
Radio Operation.....	7
Switch Between USA area and Europe area Frequency.....	7
Change Bands (BAND).....	7
Manual Tuning (◀▶).....	7
Auto Seek Tuning (◀▶).....	7
To Store/Recall Preset Stations (1 - 6).....	7
Automatic Store Station / Preset Station Scan (AMS).....	7
Local/DX.....	7
Stereo/Mono.....	7
Disc/USB/Micro SD Card Operation.....	8
To Insert Disc/USB/Micro SD Card.....	8
Eject Disc/USB/Micro SD Card.....	8
Play/Pause.....	8
Next/Previous Track.....	8
Fast Forward/Backward.....	8
Introduction Scan.....	8
Repeating the same track.....	8
Playing All Tracks in Random.....	8
Track/Folder Navigation.....	8
Select the track or file for playback in MP3 format.....	9
Auxiliary Input operation.....	9
Bluetooth Operation.....	10
Pair and Connect.....	10
Make a Call.....	10
Redial Last Dialed Number.....	10
Answer a Call / Reject a Call / End a Call.....	10
Switch Audio Between Car audio and Mobile Phone.....	10
Adjust Talk Volume.....	10
Audio Streaming (A2DP).....	10
Remote Control.....	11
Specifications.....	12
Troubleshooting.....	13

PRECAUTIONS

How to Handle Discs

- Handle a disc by its edges. Do not touch the playing side
- Before inserting a disc, wipe the disc outward from the disc center with a clean, soft, dry and lint-free cloth. Do not use solvents or thinners such as petrol/benzene or cleaners.
- After removing a disc from the disc slot, place the disc in a sleeve or case to keep it clean and prevent scratches.
- Do not stick paper or tape on the disc surface. If there is glue (or adhesive) on the disc surface, remove it before using the disc.



Precautions & Warnings

- To reduce the risk of fire, electric shock, and interference, do not attempt to repair this unit yourself. Refer all service to a qualified technician.
- Some MP3/WMA files may not be playable.
- Keep the volume at a reasonable level to avoid distracted driving. High volume levels may make it difficult to concentrate on traffic and road conditions while driving.
- If the car has been in direct sunlight for an extended period, you may need to reduce the temperature inside the car before turning on and using the unit.
- If the battery is disconnected, discharged, or changed, the preset memory of the unit will be lost and require reprogramming.
- The unit is designed to be installed in a level, horizontal position.
For optimal performance, avoid installing the unit at an angle.
- Never use excessive force when removing or attaching the faceplate.
Do not tightly grip the display and buttons to avoid damage.

Lithium Battery Cell Warnings

- Cell leakage may cause damage to the remote control.
- Do not throw cells into as this may cause an explosion.
- Keep battery cells out of reach of children.

Drives and connections

Never place any foreign objects into the openings of the car radio (disc compartment, USB jack, card slot, AUX IN connection). Otherwise you might damage the slots and connections.

Others Warnings

Do not switch on the car radio for long periods of time when the motor is switched off. This could cause the car battery to discharge and the vehicle can no longer be started.

INSTALLATION

Installation Opening

This unit can be installed in any dashboard Having an opening as shown the right figure.

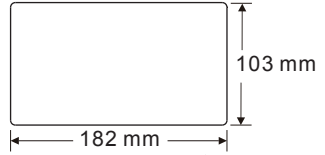

If installation angle exceeds 30 horizontal, the unit may not perform properly.

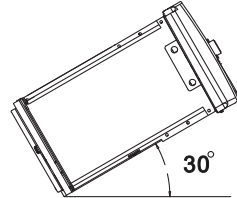

To Install the Car Radio

1. Make sure the ignition is turned off, and then disconnect the cable from the vehicle battery's negative (-) terminal. You never want electricity running while you install this double-DIN car receiver.
2. Before installation, remove the transport screws, disconnect the wire harness and the antenna.
3. Attach the "L" brackets (2pcs) on the both sides of the car receiver with screws(M5 x 8BM) as shown as the below figure. The others fixing screws that fix the other terminal of the "L" metal bracket, please buy from your dealer according to the drilling of holes size.
4. Consult with you nearest dealer if installation requires the drilling of holes or other modifications of the vehicle.
5. Install the car receiver in the dashboard.
6. Connect the wire harness & the antenna to the car receiver (see "Electrical Connections") being careful not to pinch any wires or cables.
7. Install the detachable faceplate & plastic outer trim ring onto the car receiver.
8. Reconnect the battery and run through all of the options on this car receiver to ensure that everything is working correctly.
9. Particulars will vary widely depending upon the kind of your car and the car you intend to install it in. Please choose the correct installation method according to the actual situation of your car. Always contact the car dealer or manufacturer if you have any questions.

Remove the transport screws before installation.

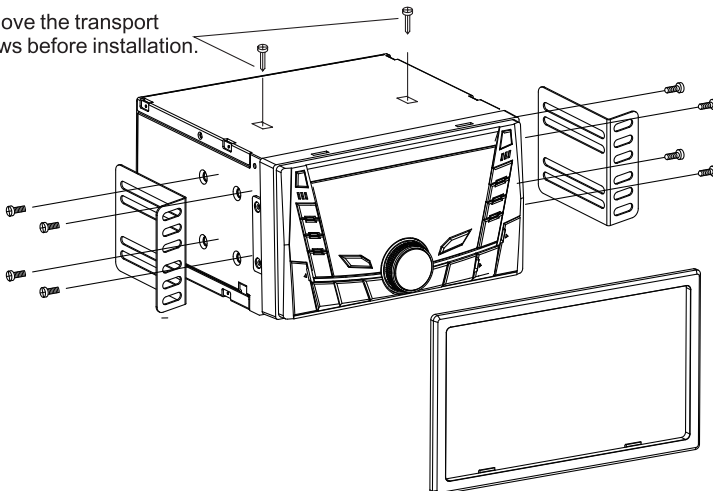

Electrical Connections

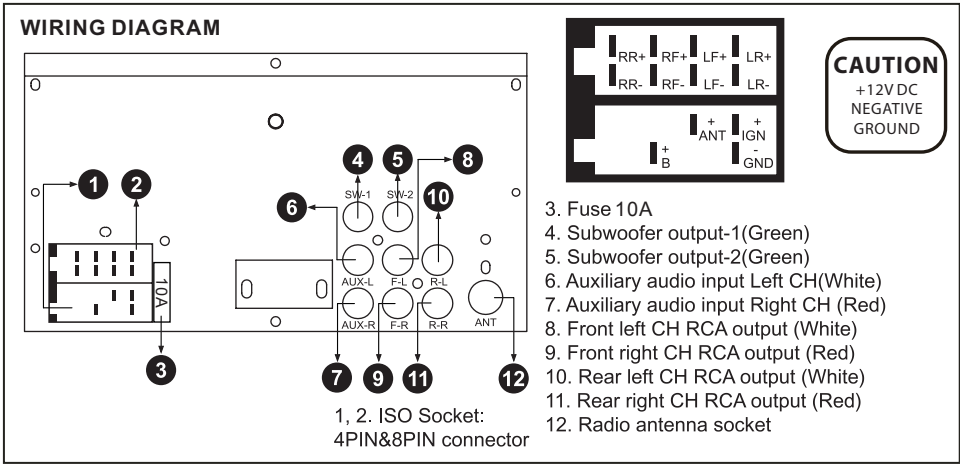

- Only use speakers with 4 ohms impedance.
- The maximum current of the auto antenna is 200mA.

CONTROL PANEL BUTTON LOCATIONS

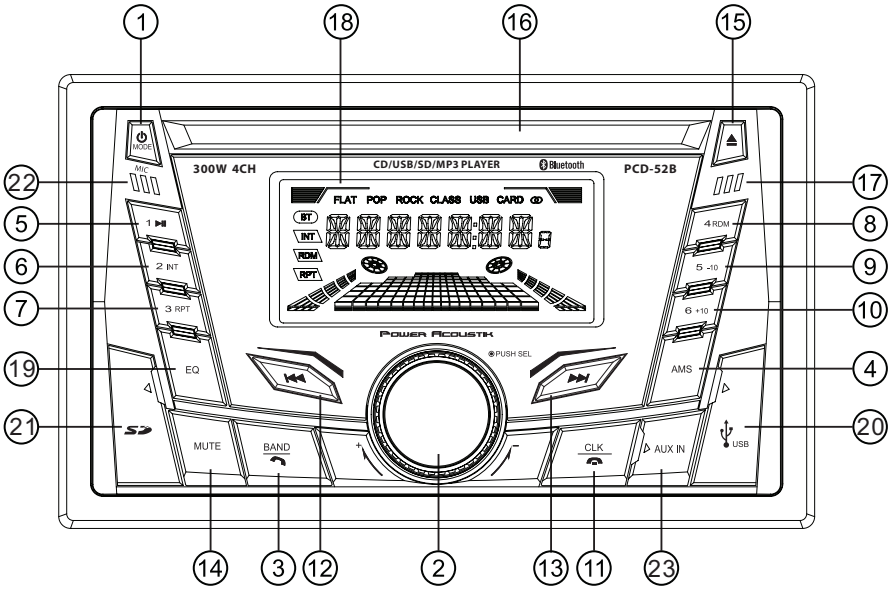

1. ⏻ (power)/MODE (source) button
2. SEL (select/menu) button and VOL (volume) knob
3. BAND (band) button, 📞 (answer call) button
4. AMS (automatic store / preset station scan, automatic music search) button
5. ▶⏸ (pause/play), Preset station 1 button
6. INT (intro), Preset station 2 button
7. RPT (repeat), Preset station 3 button
8. RDM (random), Preset station 4 button
9. -10 (previous 10 tracks), Preset station 5 button
10. +10 (next 10 tracks), Preset station 6 button
11. CLK (clock setting) button, 📞 (end call) button
12. ⏪ (tune down, seek down, track down, fast reverse) button
13. ⏩ (tune up, seek up, track up, fast forward) button
14. MUTE button
15. ▲ (eject) button
16. Disc slot
17. IR remote control sensor
18. LCD Display
19. EQ (Equalizer Preset) Button
20. USB port
21. Micro SD Card Slot
22. MIC hole (built-in Microphone)
23. AUX IN (auxiliary input) jack

GENERAL OPERATION

Turn Unit On/Off

- Press any button on the front panel or on the remote control to turn on the unit.
- Press and hold the power (⏻) button on the front panel or on the remote control to turn the unit on or off.

Adjust Volume (VOL)

Rotate the **VOL** knob on the front panel or press the **VOL+ ▲** / **VOL- ▼** button on the remote control to increase or decrease the volume level.

Adjust Menu Options (SEL)

- Press the **SEL** button on the front panel or on the remote control repeatedly to cycle through the following adjustable audio functions: BASS, TREBLE, BALANCE, FADER, EQ OFF/FLAT/POP/ROCK/CLASS, LOUD ON/OFF, CLR BLUE / CLR RED / CLR CYAN / CLR GREEN / CLR PURPLE / CLR YELLOW / CLR GRAY / CLR AUTO, DX/LOC, STEREO/MONO, VOL LAS / ADJ, AREA US/EU, CLOCK 12/24, BEEP ON/OFF, VOLUME.

- Rotate the **VOL** knob on the front panel or press the **VOL+ ▲** / **VOL- ▼** button on the remote control to adjust the selected item.

- BASS/TREBLE:-07,-06, ~, -01,00,+01,~, +06,+07

- BALANCE:L07,L06,~, L01, 00, R01,~,R06,R07

- FADER:R07,R06~,R01,00,F01,~,F06,F07

- EQ(Equalizer) Setting:OFF, FLAT, POP, ROCK, CLASS

- Loudness: LOUD ON/OFF

- 7 color-changing illumination:

This car radio device is equipped 7 color-changing illumination feature.

You can preset the illumination to Blue, Red, Cyan, Green, Purple, Yellow, Gray or color Auto(color automatically change one by one).

- DX/LOCAL: Enables or disables the local broadcast mode (LOCAL).

- Stereo/Mono: Switches between MONO and STEREO reception mode for radio frequencies.

- VOL(LAS/ADJ):This option allows you to preset a volume level as the power-on memory volume level.

- VOL LAST: In this mode,the unit switches on at the actual volume it had when it was last switched off.

- VOLADJ: In this mode, the unit power on at the actual volume that you presetted a constant switch-on volume level.

Press the **SEL** button to enter the constant switch-on volume adjusting mode and the "A-VOL XX" will be shown on the LCD display.

Then you can adjust a constant switch-on volume level by rotating the **VOL** knob.

- AREA US/EU: This car radio is equipped the USA / Europe frequency.

Rotate the volume knob to switch between USA and Europe frequency.

The system will change the frequency setting in about 3 seconds.

- CLOCK 24/12:

This unit is equipped with two types of clock display formats, 24 and 12 hours.

Rotate the volume knob to choose 24 hours format or 12 hours format.

- BEEP ON/OFF:Enables or disables the "BEEP" signal to confirm use.

- Volume level:00,01,~,40

GENERAL OPERATION (CONT.)

• Rotate the **VOL** knob on the front panel or press the **VOL+** ▲/**VOL-** ▼ button on the remote control to adjust the selected item.

Set the Clock (CLK)

1. To display clock time, press the **CLK** button.
2. To set clock time, press and hold the **CLK** button and the hour will flash.
3. Press the ◀◀ or ▶▶ button on the front panel or on the remote control to adjust the hour.
4. Press the **CLK** button and the minutes will flash.
5. Press the ◀◀ or ▶▶ button on the front panel or on the remote control to adjust the minute.
6. Note: During Bluetooth mode, the clock can not be adjusted.

Change the Source (MODE)

Press the **MODE** button to switch between RADIO, BT(Bluetooth), DISC(with a CD/MP3 disc inside the disc slot), USB(with USB device inserted), CARD(with SD card inserted) and AUX-IN(auxiliary input) modes.

Mute on/off

In power on mode, briefly press the **MUTE** button to toggle mute on or off. The muted state will be also released when the volume knob is used.

Loudness on/off

Press the **LOUD** button on the remote control to turn on the loudness to reinforce the output of bass frequencies, press again to turn it off.

Preset EQ (Equalizer)

Press the **EQ** button on the front panel or on the remote control to toggle between EQ OFF, FLAT, POP, ROCK, CLASS.

USB port

The USB port of this car radio is designed for media playback from flash memory devices.

Micro SD card slot

This micro SD card slot is designed for media playback from micro SD card.

Built-in Microphone

To receive your voice when you calling by using this bluetooth handsfree system.

Aux input connector

The 3.5mm auxiliary input stereo connection is designed for deiveces with 3.5mm line-out or headphone output.

RADIO OPERATION

Switch Between USA area and Europe area Frequency

In radio mode, press the **VOL** button to enter the switch state of the US(USA) and EU(europe) frequency, then rotate it to switch between US(USA) and EU(europe) frequency. The system will change the frequency setting in about 3 seconds.

Change Bands (BAND)

Press the **BAND** button to switch between the FM1, FM2, FM3, AM1 and AM2 bands. Each band stores up to six preset stations.

Manual Tuning (◀◀ / ▶▶)

Press and hold the ▶▶ or ◀◀ button on the front panel or on the remote control to enter manual tuning mode. In manual tuning mode, press the ▶▶ or ◀◀ button to move the radio frequency number up or down one step.

Auto Seek Tuning (◀◀ / ▶▶)

In standby mode or while not in manual tuning mode, quickly press the ▶▶ or ◀◀ button to move to the next/previous available station automatically.

To Store / Recall Preset Stations

The radio can be stored 6 preset stations for each band (FM1, FM2, FM3, AM1 and AM2) for a total of 30 preset stations.

To memorize a station:

- Turn the radio on and select the desired band and station.
- Select a station by ▶▶ or ◀◀ button.
- Press and hold the desired preset button (numbered 1-6 on the face of the radio) for more than 2 seconds to save the station to that preset number.

- To recall a preset station:

- Select the desired band.
- Briefly press a preset button (numbered 1-6) to recall the corresponding preset station.

Automatic Store station/ Preset station scan (AMS)

Press and hold the **AMS** button for more than 2 seconds to select six strong stations and store them in the current band. The radio will automatically scan the current frequency and enter the six strongest stations into the preset memory positions for that band.

Briefly press the **AMS** button on the remote control to recall each preset station that saved in the memories in each band.

LOCAL/DX

In urban areas, most stations are strong enough and "LOCAL ON" mode should be selected. Switch to LOCAL OFF mode to search for stations with weaker signals.

Press the **LOC** button on the remote control to choose local or distant reception mode.

STEREO/MONO

FM station is received in stereo mode. However, if the signal is weak or reception is not as good as you would like, switching to MONO mode usually improves the overall sound quality. Press the **ST** button on the remote control to choose FM STEREO or MONO audio effect.

DISC / USB / MICRO SD CARD OPERATION

To insert DISC / USB / SD CARD

- To play files on a disc, insert a disc with the label surface facing upward into the disc slot. Playback will begin automatically.

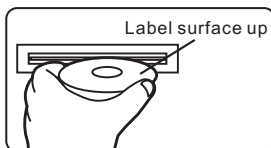

- To play files in a USB device or an SD card, open the USB port cover and insert the USB storage device into the USB port or an micro SD card into the micro SD card slot. Playback will begin automatically.

Eject Disc/USB/Micro SD

- To eject a disc, press the **▶||** button to stop playback. Press the **▲** (eject) button to eject the disc and then remove it
- To eject a USB device, press the **▶||** button to stop playback, then remove the USB device.
- To eject an Micro SD card, press the **▶||** button to stop playback, then press the micro SD card, to eject the SD card then remove the SD card from the micro SD card slot.

Play/Pause

Press the **▶||** (play/pause) button to pause or resume playback.

Next/Previous Track

- To play the next track, press the **▶▶** button.
- To play the previous track, press the **◀◀** button.

Fast Forward/Backward

- To fast forward, press and hold the **▶▶** button.
- To fast backward, press and hold the **◀◀** button.

Introduction Scan

Press the **INT** button to play the first 10 seconds of each track, press again to stop the introduction scan, and play the current track.

Repeating the same track

Press the **RPT** button to repeat the current track, press again to stop repeat playback and resume normal playback.

Playing all tracks in random

Press the **RDM** button to play all tracks in random order, press again to cancel this function.

Track/Folder Navigation

- During a disc, USB or micro SD card mode, press the **5/-10** button to go backward 10 tracks. Press the **6/+10** button to jump forward 10 tracks.
- During a MP3 disc, USB or SD card mode, press and hold the **5/-10** button to go back the previous folder. Press and hold the **6/+10** button to go to the next folder. You can repeat this function depending on the number and level of folders.
- These buttons have no this function if the USB device or SD card has no folders.

DISC / USB / MICRO CARD OPERATION (CONT.)

Select the track or file for playback in MP3 format

Press the **AMS** button repeatedly to select one of the following 3 search modes:

- NUM SCH (Searching by track or file serial number)
- DIR SCH (Searching by folder serial number)
- FILE SCH (Searching by track or file name)

Searching by track or file serial number:

- a) In playback of files with MP3 format, press the **AMS** button once to access the track or file number searching mode which allow you to quickly find a specific MP3 track or file by its serial number, and the "NUM SCH" and "NUM ***" will appear on the LCD display in sequence, and the first symbol "*" will blink.
- b) Rotate the **VOL** knob to select the serial number of your favorite file with high speed.
- c) Finally press the **SEL** button to confirm and play the selected file.

Searching by folder serial number:

The folder search mode allows you to quickly find an MP3 track or file under a specific group folder.

- a) In playback of files with MP3 format, press the **AMS** button twice, the "DIR SCH" will be shown on the LCD display.
- b) Rotate the VOL knob to select a desired folder. If there are no root Folder in the MP3 disc, USB or SD card, the LCD will display "ROOT"
- c) Press the **SEL** button to play the first track or file of the selected folder.

Searching by track or file name:

This track or file name search function requires only the first few character as search keyword, it will allow you to quickly find an MP3 title by its name.

- a) Press the **AMS** button three times, the "FILE SCH" and "*-----" will be shown on the LCD display in sequence, and the first character "*" will blink.
- b) Rotate the VOL knob to change the first character (*). The character will be changed from "A" to "Z", "0" to "9" and "_", "-", ".", "+", "space". Press the **SEL** button to confirm the character entered and the next character will blink for setting. Press the **AMS** button to delete the incorrect character.
- c) When matched files was found, press the **SEL** button to start play the searched file. If the file was not found, "NO FOUND" message will be visible on the display.

AUXILIARY INPUT OPERATION

This car radio is equipped an external auxiliary input jack (3.5mm) on the front panel, and a pair audio auxiliary input RCA connector at the rear cabinet of the head unit, it is compatible with audio output from an MP3 music player.

If you have plugged such a player into the AUX IN jack with a audio cable. Or connect other audio device to the audio auxiliary input RCA connector on the rear cabinet of the head unit with a audio input cable. Press the **MODE** button to switch to the AUX input mode, then you can listen to music from external devices.

Note:

Do not use the AUX IN jack and the audio auxiliary input RCA connector at the same time, otherwise, it will cause the audio auxiliary function unusable.



BLUETOOTH OPERATION

Pair and Connect

Prior to using the Bluetooth device as a handsfree system for a Bluetooth-enabled mobile phone for the first time, you must pair and connect the two devices as follows:

1. In any mode, prior to pairing and connecting, the BT logo in the LCD indicating that no device is connected. To begin pairing, enable BT mode on your mobile phone.
2. When the phone finds the car audio system, the "Power Acoustik" name will be displayed.
3. Choose the "Power Acoustik" from the device list to pair and connect with the car audio system. Upon confirming, the BT logo will stop flashing.
4. When pairing is complete, the mobile phone audio will automatically transfer to the car audio system whenever a call is made or received, or when the mobile phone plays music.

Make a Call

- To make a call, dial the call directly from the paired mobile phone.
- To make a call with this bluetooth handsfree system:
 - a) When linking up the Bluetooth-enabled mobile phone to this bluetooth handsfree system, press the  button to access the dial telephone number mode, then press the "0~9", * and # button on remote control to input the telephone number, and the entered number will be shown on the LCD.
 - b) If a number has been incorrectly inputted, press the **DEL** button or  button to delete it.
 - c) Press the  button to make outgoing call.

Redial Last Dialed Number

Press and hold the  button on the control panel to redial the last dialed phone number.

Answer a Call

- When the mobile phone is called, the incoming telephone number displays in the LCD.
- To receive the call, press the  button on the control panel.

Reject a Call

To reject the call, press the  button on the control panel.

End a Call

To end an active call, press the  button.





Switch Audio Between Car Audio and mobile Phone

During a call, press the **VOL** knob/button to switch the audio source from the car audio system back to your mobile phone.

Adjust Talk Volume

- During a call, use **VOL** knob or **VOL+**  / **VOL-**  button to adjust the volume level.
- Use the **MUTE** button to mute sound.

Audio Streaming (A2DP)

1. Press the  / **MODE** button to enter BT mode.
2. When a mobile device is paired, music played through that device will automatically be heard through the car audio system.
3. Press the  or  button to play the next or previous on the mobile phone.
4. Press the  button to pause or resume music playback.

REMOTE CONTROL

Remove Insulating Sheet

The remote control comes with an insulating sheet attached to the underside of the remote control, as illustrated on the right. The remote control will not work until the insulating sheet is removed.

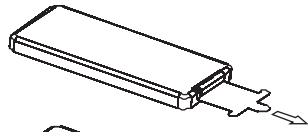

Replace Lithium Battery Cell

1. When the lithium cell battery becomes weak, replace it as illustrated on the right.
2. Press and hold the movable block in the direction indicated by arrow 1. At the same time, pull the cell holder out of the remote control in the direction indicated by arrow 2.
3. Replace the old cell with a new one, making sure the (+) polarity is facing upward.
4. Re-insert the cell holder into the remote control.

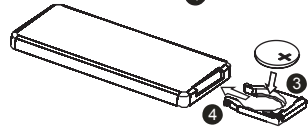
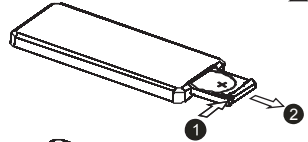

- Cell leakage may cause damage to the remote control.
- Do not throw cells into fire as this may cause an explosion.
- Keep battery cells out of reach of children.

Remote Control Operation

Position the emitting window of the remote control toward the sensor window of the unit.

- The operation angle for front panel remote control reception is about 30 degrees.
- The distance between the emitting window of the remote control and the sensor window of the unit should remain less than 5 meters.

Button Names and Locations

1. Power on/off button
2. VOL+/VOL- (volume increase/decrease) button
3. Band button, BAND
4. Tune down, seek down; Track down, fast reverse
5. SEL (selection) button
6. Tune up, seek up; Track up, fast forward
7. Mute button, DEL (Delete) button
8. CLK (clock setting) button, END (end call) button
9. 1 (preset station 1 button, keypad 1)
10. INT (intro) button, preset station 2 button, keypad 2
11. RPT (repeat) button, preset station 3 button, keypad 3
12. RDM (random), preset station 4 button, keypad 4
13. -10 (previous 10 tracks), preset station 5 button, keypad 5
14. +10 (next 10 tracks), preset station 6 button, keypad 6
15. ST (stereo) button, keypad 7
16. LOUD (loudness) button, keypad 8
17. AMS (automatic music search) button, keypad 9
18. MODE button, keypad *
19. EQ (Equalizer) button, keypad 0
20. LOC (local)/DX button, keypad #



Note: When using the remote control for the first time, you must pull out the protective plastic tab from the battery compartment found on the back of the remote control.

SPECIFICATIONS

General

Chassis Dimensions.....	178(W) x 160(D) x 100(H) mm
Power Supply Requirement	DC 12V
Current Consumption	10A (max.)
Maximum Power Output	75W x 4CH

Radio

FM

USA/ Europe Frequency Range.....	87.5 - 107.9 MHz (200KHz/Step)
	87.5 - 108.0 MHz(50KHz/Step)
Usable Sensitivity	30 dBu
I.F. Frequency	10.7 MHz

AM

USA/ Europe Frequency Range.....	530 - 1710KHz (10KHz/Step)
	522 - 1620 KHz (9KHz/Step)
Usable Sensitivity	20 dBu
I.F. Frequency	450 KHz

CD/USB/Card

Usable Audio Formats	CD/MP3/WMA
USB Port Type.....	2.0
Card Type.....	Micro SD card
Pre-amp Output	Front and Rear
Frequency Response	20 Hz - 20 KHz
S/N Ratio	60dB

BT

BT Profile supports	A2DP, AVRCP,HSP, HFP
Range of frequency	2.4GHz spectrum

TROUBLESHOOTING

The following chart will help in solving most problems that may occur. If you still have questions after going through the checklist, please consult your local customer service representative. Before going through this check list, refer the wiring and operating procedures.

Symptom	Cause	Solution
No power	The car ignition switch have not turn on.	If the power supply is connected to the car accessory circuits, but the engine is not moving, switch the ignition key to "ACC".
	The fuse has been blown.	Replace a new one.
Disc can not be loaded or ejected.	Presence of CD disc inside the player.	Remove the disc from the player, and insert a new one.
	Inserting the disc in reverse direction.	Insert the CD with the label facing upward.
	The surface of CD is extremely dirty or has been scraped.	Clean the disc or try to replace a new one.
	Temperature inside the car is too high.	Cool off or until the ambient temperature return to normal.
	Condensation	Leave the player off for an hour or so, and then try again.
No sound	Volume is in minimum.	Adjust volume to a desired level.
	The wiring is not properly connected.	Check wiring connection.
Sound skips	The installation angle is more than 30°.	Adjust the installation angle less than 30°.
	The surface of CD is extremely dirty or has been scraped.	Clean the disc or try to replace a new one.
The operation keys do not work	1. Car interior is too hot.	1. Allow vehicle to cool before using this player.
	2. The front panel has not properly installed.	2. Fixed the front panel into its place.
No radio reception.	The antenna cable is not connected.	Insert the antenna cable firmly into the antenna socket of this radio.
In automatic search mode the radio does not stop at a transmitting station.	The transmission signals are too weak.	Select a radio station manually.

