

## AV RECEIVER

Operating Instructions **EN**

Mode d'emploi **FR**

Manual de instrucciones **ES**

### Owner's Record

The model and serial numbers are located on the bottom of the unit.

Record the serial number in the space provided below.

Refer to these numbers whenever you call upon your Sony dealer regarding this product.

Model No. XAV-AX8500

Serial No. \_\_\_\_\_

**To cancel the demonstration (Demo Mode) display, see page 6.**

**Pour annuler l'affichage de démonstration (Mode démo), reportez-vous à la page 6.**

**Para cancelar la pantalla de demostración (Modo de prueba), consulte la página 6.**



XAV-AX8500(UC)

[https://rd1.sony.net/help/ev/xav-ax8500/h\\_zz/](https://rd1.sony.net/help/ev/xav-ax8500/h_zz/)



\* 5 0 5 0 1 3 2 1 1 \* (1)

## Warning

For safety, be sure to install this unit in the dashboard of the car as the rear side of the unit becomes hot during use.  
For details, see "Connection/Installation" (page 9).

The nameplate indicating operating voltage, etc., is located on the bottom of the chassis.

## WARNING

**To prevent fire or shock hazard, do not expose the unit to rain or moisture.**

**To avoid electrical shock, do not open the cabinet. Refer servicing to qualified personnel only.**

**FOR THE CUSTOMERS IN THE USA. NOT APPLICABLE IN CANADA, INCLUDING IN THE PROVINCE OF QUEBEC.**

**POUR LES CLIENTS AUX ÉTATS-UNIS. NON APPLICABLE AU CANADA, Y COMPRIS LA PROVINCE DE QUÉBEC.**

This equipment has been tested and found to comply with the limits for a Class B digital device, pursuant to Part 15 of the FCC Rules. These limits are designed to provide reasonable protection against harmful interference in a residential installation. This equipment generates, uses, and can radiate radio frequency energy and, if not installed and used in accordance with the instructions, may cause harmful interference to radio communications. However, there is no guarantee that interference will not occur in a particular installation. If this equipment does cause harmful interference to radio or television reception, which can be determined by turning the equipment off and on, the user is encouraged to try to correct the interference by one or more of the following measures:

- Reorient or relocate the receiving antenna.
- Increase the separation between the equipment and receiver.
- Connect the equipment into an outlet on a circuit different from that to which the receiver is connected.
- Consult the dealer or an experienced radio/TV technician for help.

You are cautioned that any changes or modifications not expressly approved in this manual could void your authority to operate this equipment.

This device complies with part 15 of FCC Rules and Innovation, Science and Economic Development Canada's licence-exempt RSS(s). Operation is subject to the following two conditions:

(1) This device may not cause harmful interference, and (2) this device must accept any interference received, including interference that may cause undesired operation.

This transmitter must not be co-located or operated in conjunction with any other antenna or transmitter.

This equipment complies with FCC/ISED radiation exposure limits set forth for an uncontrolled environment and meets the FCC radio frequency (RF) Exposure Guidelines and RSS-102 of the ISED radio frequency (RF) Exposure rules. This equipment should be installed and operated keeping the radiator at least 20 cm or more away from person's body.

Data transmission is always initiated by software, which is the passed down through the MAC, through the digital and analog baseband, and finally to the RF chip. Several special packets are initiated by the MAC. These are the only ways the digital baseband portion will turn on the RF transmitter, which it then turns off at the end of the packet. Therefore, the transmitter will be on only while one of the aforementioned packets is being transmitted. In other words, this device automatically discontinues transmission in case of either absence of information to transmit or operational failure.

### **If you have any questions about this product:**

**Visit:** <https://www.sony.com/electronics/support>  
**Contact:** Sony Customer Information Service Center at 1-800-222-7669

Supplier's Declaration of Conformity

Trade Name: SONY

Model: XAV-AX8500

Responsible Party: Sony Electronics Inc.

Address: 16535 Via Esprillo, San Diego, CA 92127 U.S.A.

Telephone Number: [858-942-2230](tel:858-942-2230)

This device complies with part 15 of the FCC rules. Operation is subject to the following two conditions:

(1) This device may not cause harmful interference, and (2) this device must accept any interference received, including interference that may cause undesired operation.

**Warning if your car's ignition has no ACC position**

Do not install this unit in a car that has no ACC position. The display of the unit does not turn off even after turning the ignition off, and this causes battery drain.

**Disclaimer regarding services offered by third parties**

Services offered by third parties may be changed, suspended, or terminated without prior notice. Sony does not bear any responsibility in these sorts of situations.

**About function update of the unit**

For the latest functions, refer to "Help Guide" on the website.

The QR code and URL can be found on the front cover.

**Important notice****Caution**

IN NO EVENT SHALL SONY BE LIABLE FOR ANY INCIDENTAL, INDIRECT OR CONSEQUENTIAL DAMAGES OR OTHER DAMAGES INCLUDING, WITHOUT LIMITATION, LOSS OF PROFITS, LOSS OF REVENUE, LOSS OF DATA, LOSS OF USE OF THE PRODUCT OR ANY ASSOCIATED EQUIPMENT, DOWNTIME, AND PURCHASER'S TIME RELATED TO OR ARISING OUT OF THE USE OF THIS PRODUCT, ITS HARDWARE AND/OR ITS SOFTWARE.

Dear customer, this product includes a radio transmitter.

Please check your vehicle operation manual or contact the manufacturer of your vehicle or your vehicle dealer, before you install this product into your vehicle.

**Emergency calls**

This BLUETOOTH car handsfree and the electronic device connected to the handsfree operate using radio signals, cellular, and landline networks as well as user-programmed function, which cannot guarantee connection under all conditions. Therefore do not rely solely upon any electronic device for essential communications (such as medical emergencies).

**On BLUETOOTH communication**

- Microwaves emitting from a BLUETOOTH device may affect the operation of electronic medical devices. Turn off this unit and other BLUETOOTH devices in the following locations, as it may cause an accident.
  - where inflammable gas is present, in a hospital, train, airplane, or petrol station
  - near automatic doors or a fire alarm
- This unit supports security capabilities that comply with the BLUETOOTH standard to provide a secure connection when the BLUETOOTH wireless technology is used, but security may not be enough depending on the setting. Be careful when communicating using BLUETOOTH wireless technology.
- We do not take any responsibility for the leakage of information during BLUETOOTH communication.

If you have any questions or problems concerning your unit that are not covered in this manual, consult your nearest Sony dealer.

## Main Unit

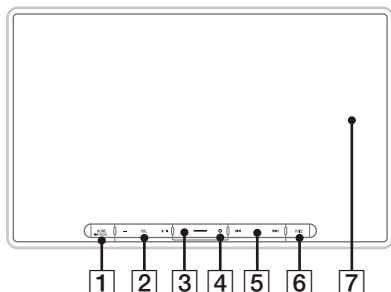

The VOL (volume) + button has a tactile dot.

### 1 HOME

Displays the HOME screen.

#### ➤ STANDBY

Press and hold to turn off the unit.

Press and hold for more than 10 seconds to reset the unit.

### 2 VOL (volume) +/-

### 3 Custom

Registers functions (Mute, Disp. Off, Source Change).

To register, select [Settings] → [Customize] → [Custom Button].

### 4 Receptor for the remote commander

### 5 ◀◀/▶▶ (previous/next)

Functions differently depending on the selected source:

- [Radio]: select a preset station.
- [SiriusXM]: select a preset channel.
- [USB]/[Bluetooth Audio]: move to the previous/next content.
- [Apple CarPlay]/[Android Auto]: move to the previous/next content.

Press and hold to:

- [Radio]: tune into a station automatically (SEEK+/SEEK-).
- [USB]/[Bluetooth Audio]: fast-reverse/fast-forward.

### 6 VOICE

Activates the voice command function for Apple CarPlay and Android Auto™.

### 7 Display/touch screen

## Screen Displays

Playback screen:

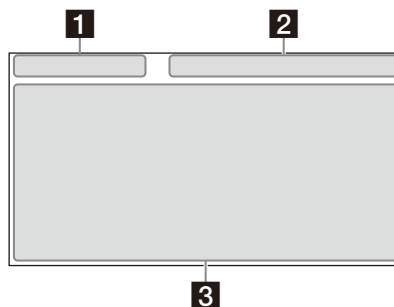

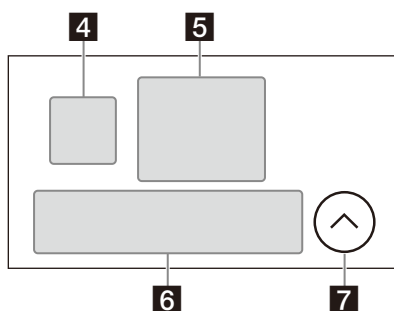

HOME1 screen:



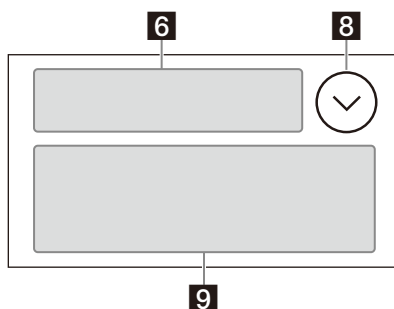



HOME2 screen:



## 1 Status indication (left side)

|   |   |
|---|---|
|  (back) | Returns to the previous display.                                    |
|  (list) | Opens the list. The available lists differ depending on the source. |

## 2 Status indication (right side)

|  |   |
|--|---|
| Clock  | Displays the time which was set on the Date/Time setting.                         |
|  (mute)    | Lights up when the sound is muted.  |
| ... (option)   | Opens the source option menu. The available items differ depending on the source. |
|  (device)  | Displays the device's name to connect to the unit.                                |
|  (antenna) | Indicates the signal strength status of the connected mobile phone.               |
|  (battery) | Indicates the remaining battery status of the connected mobile phone.             |

## 3 Application specific area

Displays playback controls/indications or show the unit's status. Displayed items differ depending on the source.

## 4 (Apple CarPlay)/ (Android Auto)

Displays when connecting Apple CarPlay/Android Auto.

## 5 Clock

Displays the date and time which were set on the Date/Time setting.

## 6 Apps area (Favorite)

Up to 5 Apps can be set. Apps can be changed. You can set your Favorite Apps.

## 7 All Apps

Opens the HOME2 screen.





















## 8 Close

Returns to the HOME1 screen.

## 9 Apps area

Displays all Apps except for Favorite Apps.

## Apps icon list

|  |  |   |
|--|--|---|
|  Android Auto     |  Apple CarPlay      |  Radio                 |
|  SiriusXM         |  Bluetooth          |  RearCam               |
|  Settings         |  USB                |  HDMI                  |
|  Camera 1         |  Camera 2           |  Phone                 |
|  Devices          |  Gauges*1*2         |  Park Assist*1*2       |
|  Vehicle Info*1*2 |  Climate*1*2        |  Satellite Radio*1*2*3 |
|  BT Audio*1*2*3   |  Media Player*1*2*3 |   |

\*1 When connecting the iDataLink Maestro module (not supplied), the icon is displayed.

\*2 Available functions differ according to your car type.

\*3 The display may be different.

## Basic Operations

### Using Apple CarPlay Wirelessly

When using Apple CarPlay for the first time, device registration is required. Follow the procedure in "Pairing with a Bluetooth® Device" (page 6).

#### Note

Make sure the GPS antenna (aerial) is connected. For details, see "Installing the GPS antenna (aerial)" (page 14).

### Using Android Auto

When using Android Auto wirelessly for the first time, device registration is required. Follow the procedure in "Pairing with a Bluetooth® Device" (page 6).

When using Android Auto with a USB cable, connect the Android Auto compatible Android™ phone to the unit with the USB cable.

### Pairing with a Bluetooth® Device

When connecting a BLUETOOTH device for the first time, mutual registration (called "pairing") is required. Pairing enables this unit and other devices to recognize each other.



When turning on the unit, the unit sends the BLUETOOTH signal.

#### To pair from the settings of this unit

- 1 Press **HOME**, then touch **[Settings]**.  
If **[Settings]** is not set in the Favorite area, touch **[All Apps]** to display the HOME2 screen, then select **[Settings]**.
- 2 Touch **[Device Connection]**.
- 3 Touch **[+Add New Device]**.
- 4 Operate the BLUETOOTH device according to its message on the **[Add New Device]** screen.  
If a passkey input is required on the BLUETOOTH device, input **[0000]**.  
The registered device name appears on the **[Device Connection]** screen.  
You can connect or disconnect the registered device on this screen.

#### To pair from the BLUETOOTH device

When setting the BLUETOOTH setting of the BLUETOOTH device to **[ON]**, select "XAV-AX8500" on the setting screen of your BLUETOOTH device and then proceed to the pairing steps. Follow the instructions on the screen of the unit.

### Canceling the Demonstration Mode

- 1 Press **HOME**, then touch **[Settings]**.  
If **[Settings]** is not set in the Favorite area, touch **[All Apps]** to display the HOME2 screen, then select **[Settings]**.
- 2 Touch **[System]**, then touch **[Demo Mode]** to set to **[Off]**.
- 3 To exit the setup menu, touch **↶** (back) twice.

### Updating the Firmware

To update the firmware, visit the support site, then follow the online instructions.

URL: <https://www.sony.com/am/support>

#### To update the firmware with USB tethering mode

When using the smartphone with tethering function, you can update the firmware with USB tethering mode.  
Connect your smartphone to the USB port, then follow the instructions on the screen of the unit.

#### Notes

- During the update with a USB connection, do not disconnect the USB cable or USB device.
- A network connection may be required, and high packet communication fees may be incurred.

## Additional Information

### Precautions

#### Note on safety

Comply with your local traffic rules, laws, and regulations.

### About iPhone

#### • Compatible iPhone models:

iPhone SE (3rd generation), iPhone 13 Pro Max, iPhone 13 Pro, iPhone 13, iPhone 13 mini, iPhone 12 Pro Max, iPhone 12 Pro, iPhone 12, iPhone 12 mini, iPhone SE (2nd generation), iPhone 11 Pro Max, iPhone 11 Pro, iPhone 11, iPhone XS Max, iPhone XS, iPhone XR, iPhone X, iPhone 8 Plus, iPhone 8, iPhone 7 Plus, iPhone 7, iPhone SE, iPhone 6s Plus, iPhone 6s, iPhone 6 Plus, iPhone 6, iPhone 5s

- Use of the Made for Apple badge means that an accessory has been designed to connect specifically to the Apple product(s) identified in the badge, and has been certified by the developer to meet Apple performance standards. Apple is not responsible for the operation of this device or its compliance with safety and regulatory standards.

Please note that the use of this accessory with an Apple product may affect wireless performance.

- Check the Apple CarPlay website for supported iOS versions. Update to the latest iOS version before use.

If you have any questions or problems concerning your unit that are not covered in this Operating Instructions, consult your nearest Sony dealer.

### Specifications

**FOR THE CUSTOMERS IN THE USA. NOT APPLICABLE IN CANADA, INCLUDING IN THE PROVINCE OF QUEBEC.**

**POUR LES CLIENTS AUX ÉTATS-UNIS. NON APPLICABLE AU CANADA, Y COMPRIS LA PROVINCE DE QUÉBEC.**

### AUDIO POWER SPECIFICATIONS



CTA2006 Standard  
Continuous Power Output:  
20 W RMS × 4 Channels at 4 Ω  
and ≤ 1% THD+N  
Signal to Noise:  
85 dBA reference 1 Watt RMS

### Monitor section

Display type: Wide LCD color monitor  
Dimensions: 25.7 cm/ 10.1 in  
System: TFT active matrix  
Number of pixels:  
2 764 800 pixels (1280 × 3 (RGB) × 720)

### Radio section

#### FM

Tuning range: 87.5 MHz – 107.9 MHz  
Usable sensitivity: 7 dBf  
Signal-to-noise ratio: 70 dB (mono)  
Separation at 1 kHz: 45 dB

#### AM

Tuning range: 530 kHz – 1 710 kHz  
Sensitivity: 32 μV

### USB player section

Interface: USB Type-C® (Hi-speed)  
Maximum current: 3.0 A

### HDMI section\*

Input format: 480p, 576p, 720p

\* HDMI output is not available.

### BLUETOOTH section

Communication System:  
BLUETOOTH Standard version 5.0  
Output:  
BLUETOOTH Standard Power Class 1  
(Max. Conducted +7.5 dBm)  
Maximum communication range\*1:  
Line of sight approx. 10 m (33 ft)  
Frequency band:  
2.4 GHz band (2.400 0 GHz – 2.483 5 GHz)  
Modulation method: FHSS  
Compatible BLUETOOTH Profiles\*2:  
A2DP (Advanced Audio Distribution Profile) 1.3.1  
AVRCP (Audio Video Remote Control Profile) 1.6.1  
HFP (Handsfree Profile) 1.7.1  
PBAP (Phone Book Access Profile) 1.2  
Corresponding codec: SBC, AAC, LDAC™

\*1 The actual range will vary depending on factors such as obstacles between devices, magnetic fields around a microwave oven, static electricity, reception sensitivity, antenna (aerial) performance, operating system, software application, etc.

\*2 BLUETOOTH standard profiles indicate the purpose of BLUETOOTH communication between devices.

## Wi-Fi section

Compatible standards:

IEEE802.11 a/n/ac

Radio frequency:

5 GHz band (5.725 GHz – 5.850 GHz)

Output power:

Max. conducted 16 dBm

Frequency Tolerance: 20 ppm

## Power amplifier section

Outputs: Speaker outputs

Speaker impedance: 4  $\Omega$  – 8  $\Omega$

Maximum power output: 55 W  $\times$  4 (at 4  $\Omega$ )

## General

Power requirements:

12 V DC car battery (negative ground (earth))

Rated current consumption: 10 A

Dimensions (maximum):

Approx. 269 mm  $\times$  167 mm  $\times$  263 mm

(10 <sup>5</sup>/<sub>8</sub> in  $\times$  6 <sup>5</sup>/<sub>8</sub> in  $\times$  10 <sup>3</sup>/<sub>8</sub> in) (w/h/d)

Mounting dimensions:

Approx. 178 mm  $\times$  50 mm  $\times$  158 mm

(7 in  $\times$  2 in  $\times$  6 <sup>1</sup>/<sub>4</sub> in) (w/h/d)

Mass: Approx. 2.6 kg (5 lb 12 oz)

Package contents:

Main unit (1)

Parts for installation and connections (1 set)

Optional accessories/equipment:

Remote commander: RM-X400

SiriusXM Connect Vehicle Tuner\*: SXV100,

SXV200, SXV300

iDataLink Maestro RR module

iDataLink Maestro RR2 module

\* Some features are compatible with SXV200 or later tuner models.

Ask the dealer for detailed information.

Design and specifications are subject to change without notice.

## Copyrights



SiriusXM-Ready® allows you to Listen to ad-free music, plus all the sports, talk, comedy, news coverage, all in one place. (SiriusXM Connect Tuner and subscription required. Sold separately.) For more information, visit [www.siriusxm.com](http://www.siriusxm.com). SiriusXM and all related marks and logos are trademarks of Sirius XM Radio, Inc. All rights reserved.

The Bluetooth® word mark and logos are registered trademarks owned by Bluetooth SIG, Inc. and any use of such marks by Sony Group Corporation and its subsidiaries is under license. Other trademarks and trade names are those of their respective owners.

Windows Media is either a registered trademark or trademark of Microsoft Corporation in the United States and/or other countries.

This product is protected by certain intellectual property rights of Microsoft Corporation. Use or distribution of such technology outside of this product is prohibited without a license from Microsoft or an authorized Microsoft subsidiary.

Apple, iPhone, and Apple CarPlay are trademarks of Apple Inc., registered in the U.S. and other countries.

iOS is a trademark or registered trademark of Cisco in the U.S. and other countries and is used under license.

Android and Android Auto are trademarks of Google LLC.

To use Android Auto on your car display, you'll need an Android phone running Android 8 or higher, an active data plan, and the Android Auto app.

To wirelessly use Android Auto on your car display, you need a compatible Android smartphone with an active data plan. You can check which smartphones are compatible at [g.co/androidauto/requirements](http://g.co/androidauto/requirements).

The Wi-Fi CERTIFIED™ Logo is a certification mark of Wi-Fi Alliance®.

LDAC and LDAC logo are trademarks of Sony Corporation.

USB Type-C® and USB-C® are registered trademarks of USB Implementers Forum.

The terms HDMI, HDMI High-Definition Multimedia Interface, HDMI Trade dress and the HDMI Logos are trademarks or registered trademarks of HDMI Licensing Administrator, Inc.

All other trademarks are trademarks of their respective owners.



## Connection/Installation

### Cautions

- Do not install this unit in a car that has no ACC position. The display of the unit does not turn off even after turning the ignition off, and this causes battery drain.
- **Run all ground (earth) leads to a common ground (earth) point.**
- Do not get the leads trapped under a screw or caught in moving parts (e.g., seat railing).
- Before making connections, turn the car ignition off to avoid short circuits.
- Connect the **yellow** and **red** power supply leads only after all other leads have been connected.
- Be sure to insulate any loose unconnected leads with electrical tape for safety.
- Choose the installation location carefully so that the unit will not interfere with normal driving operations.
- Avoid installing the unit in areas subject to dust, dirt, excessive vibration, or high temperature, such as in direct sunlight or near heater ducts.
- Use only the supplied mounting hardware for a safe and secure installation.
- Be sure to use the supplied USB extension cables.
- This unit may not be installed properly depending on the car type. For details on the mounting space, see "Ensuring the mounting location of the unit" (page 10).
- To avoid injury, be careful not to drop the display during installation.
- When installing, be careful not to cut off your fingers with the metal parts of the brackets and mounting base.
- Do not pinch your fingers when attaching the display to the unit.
- Do not install the unit in a position where the unit interferes with driving operations (such as in positions where the shift lever hits the unit, or the hazard button cannot be pressed).
- When using the unit for a long period of time, there may be a possibility that the screws securing the display may come loose. Periodically tighten these screws.
- Do not make any changes or modifications to the unit other than those described in this manual.

### Note on the power supply lead (yellow)

When connecting this unit in combination with other stereo components, the amperage rating of the car circuit to which the unit is connected must be higher than the sum of each component's fuse amperage rating.

### Note on installing in cars with a start-stop system

The unit may restart when starting the engine from start-stop. In this case, turn off the start-stop system of your car.

### Note on installing in cars with electric parking brake system

For cars with electric parking brakes, some related functions (such as video blocking function) may not work properly.

### Mounting angle adjustment

Adjust the mounting angle to less than 30°.

## Ensuring the mounting location of the unit

Before installing the unit, consult the installer for details on the installation of the unit and the display.

- Make sure that the distance from the front surface (reference surface) of the mounted unit to the surface of your car's center cluster is within 22 mm (7/8 in). If exceeded, the unit cannot be installed properly.

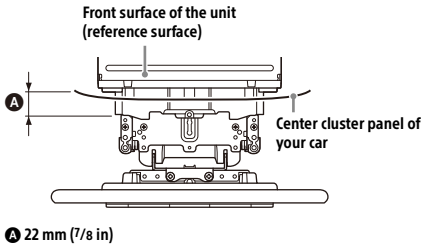

- Adjust the angle of the display before installing to the unit.

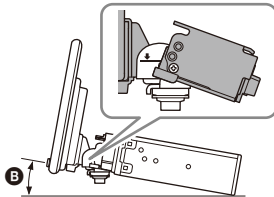

**B** (Installed angle) changes depending on the mounting locations of the pre-installed screws.

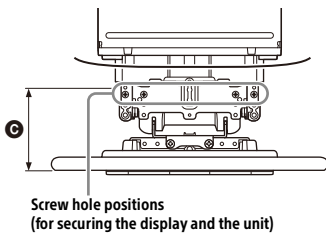

**C** (Display position) changes depending on the mounting locations of the pre-installed screws.

- For your safety, adjust the mounting location of the unit so that it does not interfere with driving operations such as button (switch) or shift lever operations.

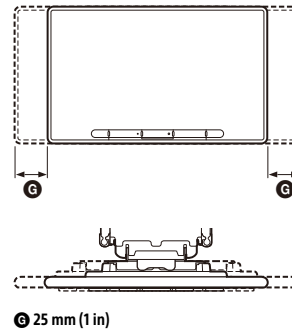
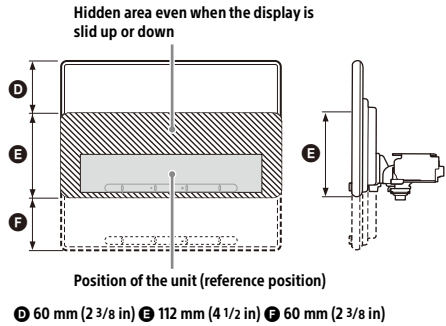

| <b>B</b> (Installed angle) | <b>C</b> (Display position)             |
|----------------------------|---|
| 0° - 20°                   | 56 mm - 76 mm (2 13/64 in - 2 63/64 in) |
| 20° - 30°                  | 55 mm - 75 mm (2 11/64 in - 2 61/64 in) |
| 30° - 40°                  | 54 mm - 74 mm (2 1/8 in - 2 29/32 in)   |

# Parts List for Installation

① Power supply leads (1)



② Connection cables (Audio/Camera) (1)



③ Mounting screw (5 × max. 9 mm (7/32 × max. 3/8 in)) (4)



④ Microphone (1)



⑤ Flat-mount base (1)



⑥ Double-sided tape (1)



⑦ USB Type-C extension cable (1)



⑧ Cable for steering wheel remote input (RC-SR1) (1)



⑨ Fixing screw (for the joint cover) (3 × 8 mm (1/8 × 11/32 in)) (1)



⑩ Fixing screw (for the joint part) (4 × 6 mm (3/16 × 1/4 in)) (4)



⑪ GPS antenna (aerial) (1)



⑫ Metal plate (1)



⑬ Rear panel cover (2)

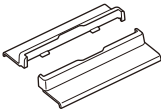

⑭ Cable tie (2)



This parts list does not include all the package contents.

# Connection

- To prevent short circuits, insulate leads with a cover or tape.
- Note that the unit may be damaged if it is connected incorrectly or by short circuits at the leads.

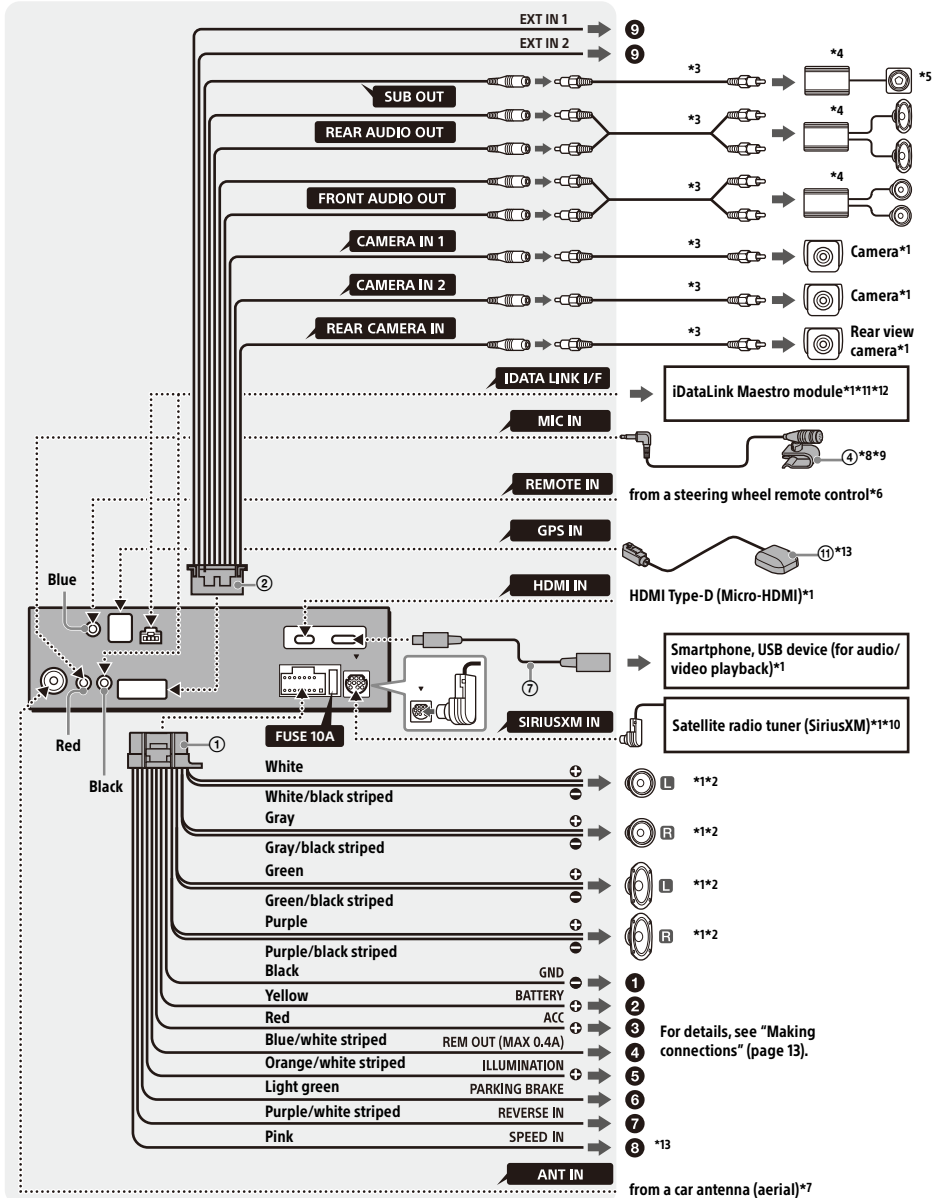

- \*1 Not supplied
- \*2 Speaker impedance: 4 Ω to 8 Ω × 4
- \*3 RCA pin cord (not supplied)
- \*4 Power amplifier (not supplied)
- \*5 Subwoofer (not supplied)
- \*6 Depending on the type of car, use an adaptor for a steering wheel remote control (not supplied).  
For details on using the steering wheel remote control, see "Using the steering wheel remote control" (page 15).
- \*7 Depending on the type of car, use an adaptor (not supplied) if the antenna (aerial) connector does not fit.
- \*8 Whether in use or not, route the microphone input cord so it does not interfere with driving operations. Secure the cord with a clamp, etc., if it is installed around your feet.
- \*9 For details on installing the microphone, see "Installing the microphone" (page 14).
- \*10 For more information on how to install the SiriusXM Connect Vehicle Tuner, consult the installation guide supplied with the tuner.
- \*11 When connecting the iDataLink Maestro module (not supplied), do not connect any device to the REMOTE IN terminal (blue). Likewise, when connecting a device to the REMOTE IN terminal (blue), do not connect the iDataLink Maestro module (not supplied) to the IDATA LINK I/F terminal (black).
- \*12 Use the connection cable supplied with the iDataLink Maestro module (not supplied).
- \*13 Connect when using Apple CarPlay with a wireless connection.

## Making connections

- 1 To a common ground (earth) point**  
First connect the black ground (earth) lead then connect the yellow and red power supply leads.
- 2 To the +12 V power terminal which is energized at all times**  
Be sure to first connect the black ground (earth) lead to a common ground (earth) point.
- 3 To the +12 V power terminal which is energized when the ignition switch is set to the accessory position**  
Be sure to first connect the black ground (earth) lead to a common ground (earth) point.
- 4 To the power antenna (aerial) control lead or the power supply lead of the antenna (aerial) booster**  
It is not necessary to connect this lead if there is no power antenna (aerial) or antenna (aerial) booster, or with a manually-operated telescopic antenna (aerial).  
**To AMP REMOTE IN of an optional power amplifier**  
This connection is only for amplifiers and a power antenna (aerial). Connecting any other system may damage the unit.

### Note

It will take about 10 seconds to shut down the output of REM OUT after the unit is turned off.

- 5 To a car's illumination signal**  
Be sure to first connect the black ground (earth) lead to a common ground (earth) point.
- 6 To the parking brake switch lead**  
The mounting position of the parking brake switch lead depends on your car.  
Be sure to connect the parking brake lead (light green) of the power supply leads ① to the parking brake switch lead.

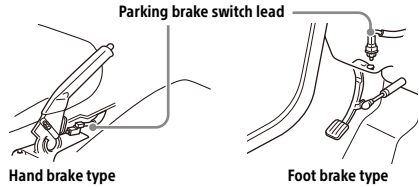

- 7 To the +12 V power terminal of the car's rear lamp lead (only when connecting the rear view camera)**
- 8 To a car's speed pulse signal**  
When using Apple CarPlay with a wireless connection, it is necessary to connect to keep the accurate location of your car.  
The mounting position of the speed pulse output lead depends on your car.
- 9 To an interruption signal (+3.3 V to +12 V) to display the picture from CAMERA IN 1 and CAMERA IN 2**  
**Note**  
REVERSE IN, EXT IN 1, and EXT IN 2 interrupt detections have the following priority levels.  
REVERSE IN always has priority; if both EXT IN 1 and EXT IN 2 occur at the same time, EXT IN 1 has higher priority.

## Camera Connection

Installation of cameras (not supplied) is required before use.

Connect the camera power cord (lead) to the accessory power terminal.

When connecting the iDataLink Maestro module (not supplied) and you are using the Backup Camera Dynamic Guidelines function, adjust the guideline.

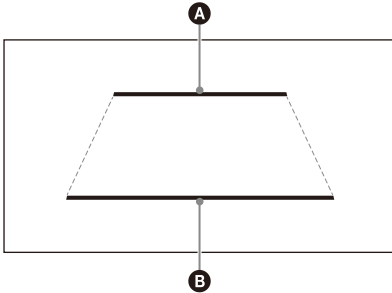

**A** 2.0 m (6 1/2 feet) behind the car

**B** 0.5 m (1 3/4 feet) behind the car

## Memory hold connection

When the yellow power supply lead is connected, power will always be supplied to the memory circuit even when the ignition switch is turned off.

## Speaker connection

- Before connecting the speakers, turn the unit off.
- Use speakers with an impedance of 4  $\Omega$  to 8  $\Omega$ , and with adequate power handling capacities to avoid damage.

## Installing the microphone

To capture your voice during handsfree calling, you need to install the microphone ④.

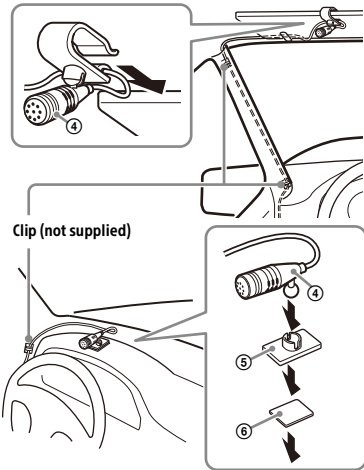

### Cautions

- It is extremely dangerous if the cord becomes wound around the steering column or gearstick. Be sure to keep it and other parts from interfering with your driving operations.
- If airbags or any other shock-absorbing equipment are in your car, contact the store where you purchased this unit or the car dealer before installation.

### Notes

- When mounting on the dashboard, remove the visor clip carefully from the microphone ④, then attach the flat-mount base ⑤ to the microphone ④.
- Before attaching the double-sided tape ⑥, clean the surface of the dashboard with a dry cloth.

## Installing the GPS antenna (aerial)

- Choose a location where no obstacle blocks GPS satellite reception so as to achieve the best reception.
- Make sure the GPS antenna (aerial) ⑩ does not interfere with the operation of car equipment.
- Some types of front windshields (windscreens) block GPS satellite radio waves. Make sure the signal reception is not blocked.
- When using Apple CarPlay with a wireless connection, make sure the GPS antenna (aerial) ⑩ is connected.

# 1 Decide the installation location on the dashboard, then clean the attachment surface.

Choose a flat surface where:

- the GPS antenna (aerial) ⑪ can be positioned horizontally.
- operation of the passenger-side airbag is not impeded.
- GPS satellite reception is not blocked by anything inside the car or the windshield (windscreen) wipers.

# 2 Remove the tape of the metal plate ⑫, then attach it on the dashboard.

# 3 Remove the tape of the GPS antenna (aerial) ⑪, then attach it on the metal plate ⑫.

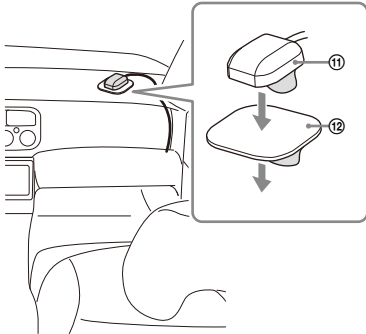

## Cautions

- It is extremely dangerous if the cord becomes wound around the steering column or gearstick. Be sure to keep it and other parts from interfering with your driving operations.
- If airbags or any other shock-absorbing equipment are in your car, contact the store where you purchased this unit or the car dealer before installation.

## Notes

- Be sure to use the metal plate ⑫, otherwise signal reception may be poor.
- Do not install the GPS antenna (aerial) ⑪ close to other electrical equipment, otherwise signal reception may be unstable.
- If the surface of the metal plate ⑫ is cold, the tape may not stick firmly. Warm up its surface with a hair dryer, etc., before applying the tape.
- If there is no flat surface on which to install the GPS antenna (aerial) ⑪, bend the metal plate ⑫ to fit a curved surface before installing.

## Using the steering wheel remote control

### When using the steering wheel remote control

Installation of the connection cable RC-SR1 ⑧ is required before use.

#### 1 Select [Settings] → [System] → [Steering Wheel Settings].

#### 2 Set the [Custom] switch to [On].

You can make the registration to enable the steering wheel remote control.

When the registration is complete, the steering wheel remote control becomes available.

### Notes on installing the connection cable RC-SR1 ⑧

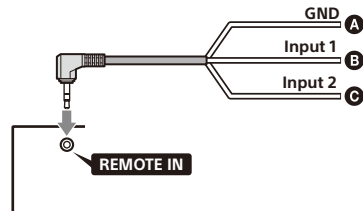

- A Black
- B Green
- C Brown

- Refer to the support site for details, then connect each lead properly to the appropriate leads. Making an improper connection may damage the unit.

URL: <https://www.sony.com/am/support>

- Consulting the dealer or an experienced technician for help is recommended.
- When connecting the iDataLink Maestro module (not supplied), do not connect any device to the REMOTE IN terminal (blue). Likewise, when connecting a device to the REMOTE IN terminal (blue), do not connect the iDataLink Maestro module (not supplied) to the IDATA LINK I/F terminal (black).

### When using an adaptor for the steering wheel remote control

Depending on the type of car, use an adaptor for the steering wheel remote control (not supplied).

#### 1 Select [Settings] → [System] → [Steering Wheel Settings].

#### 2 Set the [Custom] switch to [Off].

The adaptor for the steering wheel remote control is enabled.

## Using a USB device and/or an HDMI device

Installation of the USB Type-C extension cable ⑦ and/or an HDMI cable (HDMI Type-D or Micro-HDMI) (not supplied) is required before mounting the unit in the dashboard.

- 1 Connect the USB Type-C extension cable ⑦ to the USB port and/or an HDMI cable (not supplied) to the HDMI terminal at the rear panel of the unit.
- 2 Pass the cable tie ⑭ through the cable holder, then tie cable tie ⑭ around the USB Type-C extension cable ⑦ and/or HDMI cable (not supplied).

The USB Type-C extension cable ⑦ and HDMI cable (not supplied) are secured to the unit.

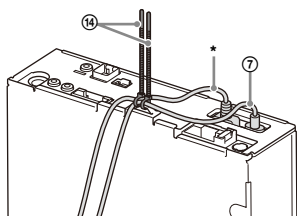

\* HDMI cable (HDMI Type-D or Micro-HDMI) (not supplied)

- 3 Connect the installed USB Type-C extension cable ⑦ to a USB device and/or HDMI cable to an HDMI device.
- 4 Press HOME, then touch [USB] or [HDMI].

### Notes

- When playing back video from an HDMI device, playback may stop when the interrupt function is activated from the Rear Camera, Camera 1, or Camera 2 depending on the connected HDMI device.  
When the interrupt function is set to [Off], video can be played without being stopped.  
Select [Settings] → [Application] → [Camera Display] → [Rear Camera Interruption], [Camera 1 Interruption], or [Camera 2 Interruption].  
When the interrupt function is set to [Off], you can display the camera video by touching [RearCam], [Camera 1], or [Camera 2] on the HOME screen.
- When the iDataLink Maestro module (not supplied) is connected, configure the interrupt function in [Maestro Settings].  
Select [Settings] → [Application] → [Maestro Settings].

## Installation

To install the unit and the display securely, be sure to follow the steps ① to ⑤ in order.

- ① Mounting the unit in the dashboard (page 16)
- ② Setting up the display (page 17)
- ③ Making sure the mounting positions of the display (page 20)
- ④ Attaching the display to the unit (page 20)
- ⑤ Adjusting the display tilt and swivel angle (page 21)

### For your safety

After mounting the display to the unit, make sure that the display does not interfere with normal driving operations such as blocking the driver's view or getting the cables tangled.

## ① Mounting the unit in the dashboard

### Using the mounting brackets supplied with your car

You may not be able to install this unit in some makes of Japanese cars. In such a case, consult your Sony dealer.

### Example

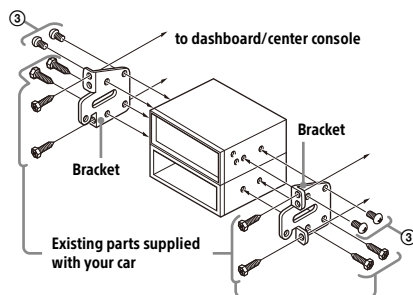

### Note

To prevent malfunction, install only with the mounting screws ③.



## 2 Setting up the display

The mounting positions of the display can be adjusted.

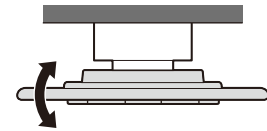
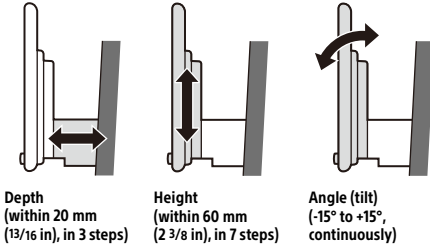

**Angle (swivel)**  
(-15° to +15°, continuously)



**Width**  
(within 25 mm (1 in), in 5 steps)

### Adjusting the depth of the display position

- 1 Loosen the 3 pre-installed screws for depth adjustment (on top and both sides).

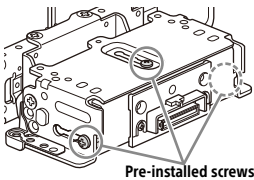

Slightly loosen the screws until you can slide the connector bracket. Do not remove the screws from the bracket. Doing so may damage the parts.

- 2 Slide the connector bracket to decide the appropriate depth position.  
Adjustable depth: within 20 mm (13/16 in) (A), in 3 steps, in 10 mm (13/32 in) pitch (B).

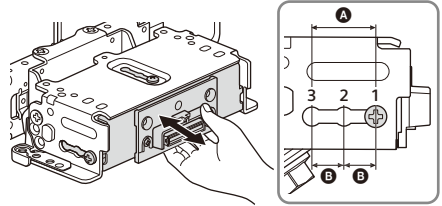

Bracket positions 1 to 3 for the display:

- 1: Slide-out position
- 2: Intermediate position
- 3: Slide-in position

- 3 At the desired position, tighten the 3 screws firmly to secure the connector bracket.

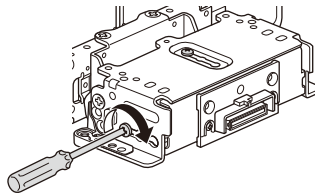

Tighten the screws firmly.  
When you tighten a screw, be careful not to apply too much torque as doing so may damage the screw (the torque value should be from 1.5 N•m to 2.0 N•m).

### Adjusting the display angle (subtilt)

- 1 Remove the 2 pre-installed screws for angle adjustment (on both sides).

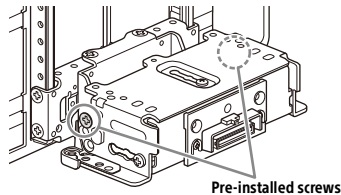

- 2** Adjust the mounting position of the screw located where the line (A) on the swivel cover is closest to the ground and oriented horizontally.

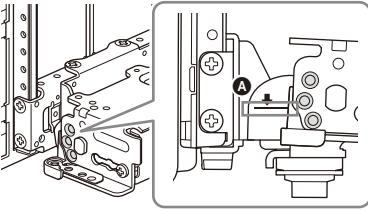

The installation angle on the vehicle is determined based on the vehicle, and the position of the pre-installed screw is determined accordingly.

Screw holes to use for each mounting angle:

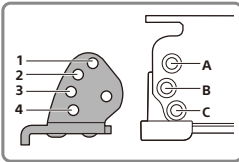

2-A

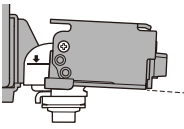

3-B

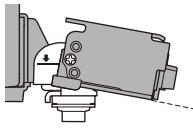

4-C

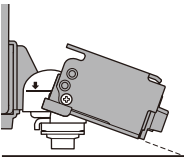

1-A

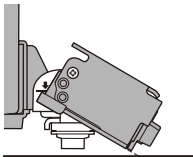

- 3** At the desired position, tighten the 2 screws through the screw holes (upper, center, or lower) that match the display angle.

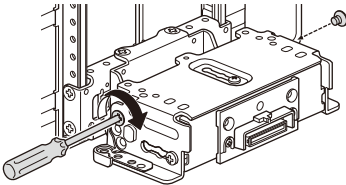

**Note**

Install the pre-installed screws in the correct positions. Installing the screws in incorrect positions will cause the display to rotate diagonally when you swivel it.

When adjusting to swivel +15°:

Correct position

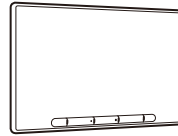

Incorrect position

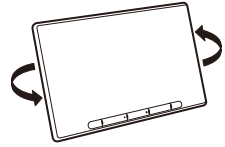

**Adjusting the height of the display position**

- 1** Remove the 4 pre-installed screws for height adjustment (on both sides).

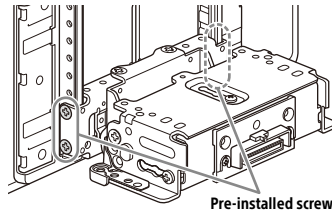

- 2** Slide the connector bracket up or down to decide the appropriate height position. Adjustable height: within 60 mm (2 3/8 in) (A), in 7 steps, in 10 mm (13/32 in) pitch (B).

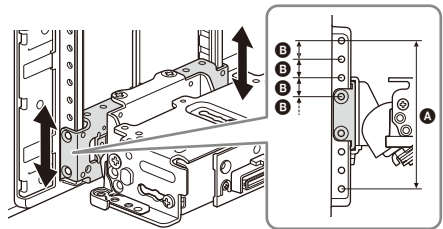

- 3** At the desired position, tighten the 4 screws firmly to secure the connector bracket.

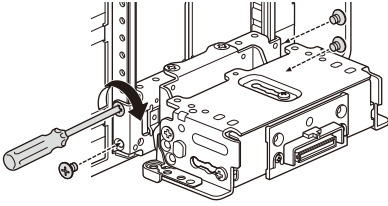

Tighten the screws firmly. When you tighten a screw, be careful not to apply too much torque as doing so may damage the screw (the torque value should be from 1.5 N•m to 2.0 N•m).

### Adjusting the width of the display position

- 1** Remove the 2 pre-installed screws on the top side and loosen the 1 installed screw on the bottom side for width adjustment.

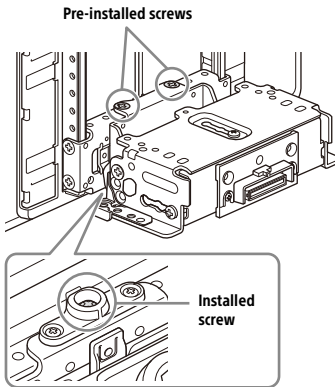

- 2** Slide the connector bracket to the left or right to decide the appropriate position. Adjustable width: within 25 mm (1 in) (A), in 5 steps, in 12.5 mm (1/2 in) pitch (B).

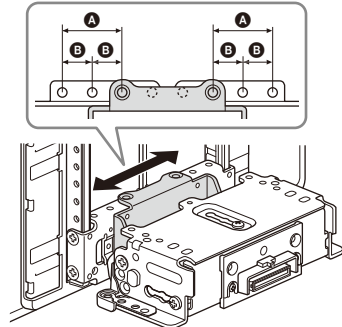

Be sure to adjust the appropriate position with the connector bracket in the same state as the illustration above. If the connector bracket is upside down, it will be stuck by the screw on the bottom side and will not move left or right.

- 3** At the desired position, tighten the 2 screws on the top side firmly to secure the connector bracket.

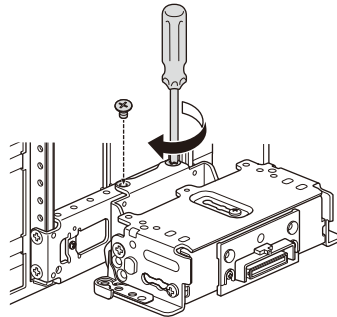

Tighten the screws firmly. When you tighten a screw, be careful not to apply too much torque as doing so may damage the screw (the torque value should be from 1.5 N•m to 2.0 N•m).

- 4** Turn the unit over, tighten the 1 screw firmly to secure the connector bracket.

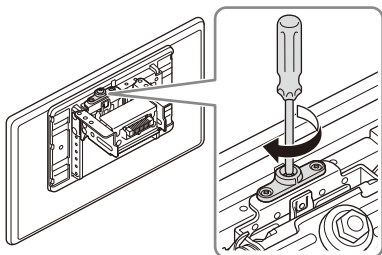

**Note**

Be sure to tighten the screws on the top side first, then tighten the screw on the bottom side.

**3 Making sure the mounting positions of the display**

Be careful not to pinch your fingers or scratch the center cluster panel of your car when attaching the display to the unit.

- 1** Attach the display to the unit temporarily.

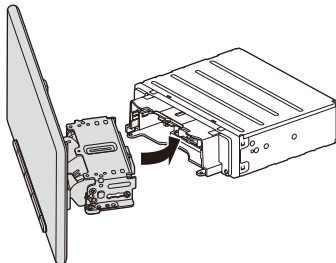

- 2** Confirm that the display does not block the driver's view or interfere with normal driving operations.

If further adjustment of the mounting position (depth, height, angle, width) is necessary, remove the display from the unit, then adjust it again accordingly.

**4 Attaching the display to the unit**

Be careful not to pinch your fingers or scratch the center cluster panel of your car when attaching the display to the unit.

- 1** Attach the display to the unit.

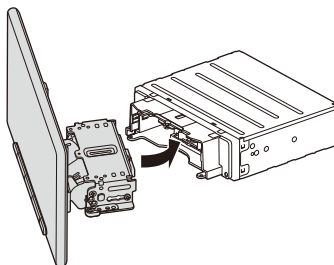

Make sure that the connector brackets of the display is fully inserted to the unit.

- 2** Tighten 4 screws ⑩ (on top) to secure the connector bracket to the unit.

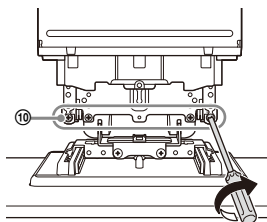

Tighten the screws firmly.

When you tighten a screw, be careful not to apply too much torque as doing so may damage the screw (the torque value should be from 1.5 N•m to 2.0 N•m).

- 3** Slide the joint cover out to protect the mounting base of the display, then tighten the fixing screw ⑨ to secure the cover.

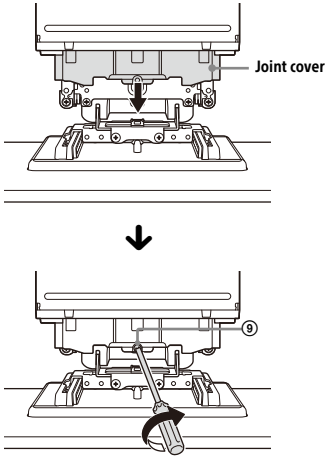

Tighten the screw firmly.  
When you tighten a screw, be careful not to apply too much torque as doing so may damage the screw (the torque value should be from 1.5 N•m to 2.0 N•m).

- 4** Attach the rear panel covers ⑬ along the guides for protection.

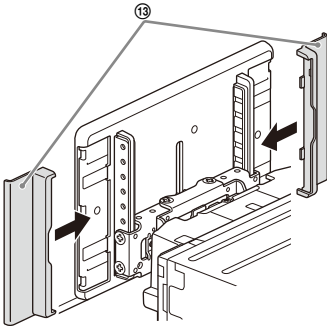

**Notes**

- Be sure to use the specified screws.
- If the display appears to rattle, tighten the screws periodically.

**5 Adjusting the display tilt and swivel angle**

After the display is installed, grip the correct parts of the display and adjust the display angle in the tilt and swivel directions.

Where to place your hands when gripping the display:

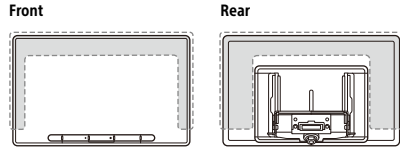

**Notes**

- When adjusting the angle of the display, grip the top, left, or right side of the display with both hands as indicated by the shaded areas.
- When adjusting the angle of the display, be careful not to get your fingers caught.

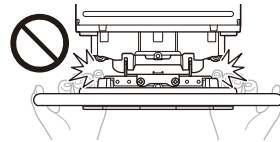

- Do not adjust the display angle while driving.
- Adjust the display angle so that the display does not obstruct moving parts of the vehicle such as the shift lever and steering wheel.

**Fuse replacement**

When replacing the fuse, be sure to use one matching the amperage rating stated on the original fuse. If the fuse blows, check the power connection and replace the fuse. If the fuse blows again after replacement, there may be an internal malfunction. In such a case, consult your nearest Sony dealer.

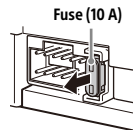

# END USER LICENSE AGREEMENT

## IMPORTANT:

BEFORE USING THE SOFTWARE, PLEASE READ THIS END USER LICENSE AGREEMENT ("EULA") CAREFULLY. BY USING THE SOFTWARE YOU ARE ACCEPTING THE TERMS OF THIS EULA. IF YOU DO NOT ACCEPT THE TERMS OF THIS EULA, YOU MAY NOT USE THE SOFTWARE.

This EULA is a legal agreement between you and Sony Electronics Inc. ("SONY"). This EULA governs your rights and obligations regarding the AV Receiver firmware of SONY and/or its third party licensors (including SONY's affiliates) and their respective affiliates (collectively, the "THIRD-PARTY SUPPLIERS"), together with any updates/upgrades provided by SONY, any printed, on-line or other electronic documentation for such software, and any data files created by operation of such software (collectively, the "SOFTWARE").

Notwithstanding the foregoing, any software in the SOFTWARE having a separate end user license agreement (including, but not limited to, GNU General Public license and Lesser/Library General Public License) shall be covered by such applicable separate end user license agreement in lieu of the terms of this EULA to the extent required by such separate end user license agreement ("EXCLUDED SOFTWARE").

## SOFTWARE LICENSE

The SOFTWARE is licensed, not sold. The SOFTWARE is protected by copyright and other intellectual property laws and international treaties.

## COPYRIGHT

All right and title in and to the SOFTWARE (including, but not limited to, any images, photographs, animation, video, audio, music, text and "applets" incorporated into the SOFTWARE) is owned by SONY or one or more of the THIRD-PARTY SUPPLIERS.

## GRANT OF LICENSE

SONY grants you a limited license to use the SOFTWARE solely in connection with your compatible device ("DEVICE") and only for your individual, non-commercial use. SONY and the THIRD-PARTY SUPPLIERS expressly reserve all rights, title and interest (including, but not limited to, all intellectual property rights) in and to the SOFTWARE that this EULA does not specifically grant to you.

## REQUIREMENTS AND LIMITATIONS

You may not copy, publish, adapt, redistribute, attempt to derive source code, modify, reverse engineer, decompile, or disassemble any of the SOFTWARE, whether in whole or in part, or create any derivative works from or of the SOFTWARE unless such derivative works are intentionally facilitated by the SOFTWARE. You may not modify or tamper with any digital rights management functionality of the SOFTWARE. You may not bypass, modify, defeat or circumvent any of the functions or protections of the SOFTWARE or any mechanisms operatively linked to the SOFTWARE. You may not separate any individual component of the SOFTWARE for use on more than one DEVICE unless expressly authorized to do so by SONY. You may not remove, alter, cover or deface any trademarks or notices on the SOFTWARE. You may not share, distribute, rent, lease, sublicense, assign, transfer or sell the SOFTWARE. The software, network services or other products other than SOFTWARE upon which the SOFTWARE'S performance depends might be interrupted or discontinued at the discretion of the suppliers (software suppliers, service suppliers, or SONY). SONY and such suppliers do not warrant that the SOFTWARE, network services or other products will continue to be available, or will operate without interruption or modification.

## EXCLUDED SOFTWARE AND OPEN SOURCE COMPONENTS

Notwithstanding the foregoing limited license grant, you acknowledge that the SOFTWARE may include EXCLUDED SOFTWARE. Certain EXCLUDED SOFTWARE may be covered by open source software licenses ("OPEN SOURCE COMPONENTS"), which means any software licenses approved as open source licenses by the Open Source Initiative or any substantially similar licenses, including but not limited to any license that, as a condition of distribution of the software licensed under such license, requires that the distributor make the software available in source code format. If and to the extent disclosure is required, please visit [oss.sony.net/Products/Linux](http://oss.sony.net/Products/Linux) or other SONY-designated web site for a list of applicable OPEN SOURCE COMPONENTS included in the SOFTWARE from time to time, and the applicable terms and conditions governing its use. Such terms and conditions may be changed by the applicable third party at any time without liability to you. To the extent required by the licenses covering EXCLUDED SOFTWARE, the terms of such licenses will apply in lieu of the terms of this EULA. To the extent the terms of the licenses applicable to EXCLUDED SOFTWARE prohibit any of the restrictions in this EULA with respect to such EXCLUDED SOFTWARE, such restrictions will not apply to such EXCLUDED SOFTWARE. To the extent the terms of the licenses

applicable to OPEN SOURCE COMPONENTS require SONY to make an offer to provide source code in connection with the SOFTWARE, such offer is hereby made.

## **USE OF SOFTWARE WITH COPYRIGHTED MATERIALS**

The SOFTWARE may be capable of being used by you to view, store, process and/or use content created by you and/or third parties. Such content may be protected by copyright, other intellectual property laws, and/or agreements. You agree to use the SOFTWARE only in compliance with all such laws and agreements that apply to such content. You acknowledge and agree that SONY may take appropriate measures to protect the copyright of content stored, processed or used by the SOFTWARE. Such measures include, but are not limited to, counting the frequency of your backup and restoration through certain SOFTWARE features, refusal to accept your request to enable restoration of data, and termination of this EULA in the event of your illegitimate use of the SOFTWARE.

## **CONTENT SERVICE**

PLEASE ALSO NOTE THAT THE SOFTWARE MAY BE DESIGNED TO BE USED WITH CONTENT AVAILABLE THROUGH ONE OR MORE CONTENT SERVICES ("CONTENT SERVICE"). USE OF THE SERVICE AND THAT CONTENT IS SUBJECT TO THE TERMS OF SERVICE OF THAT CONTENT SERVICE. IF YOU DECLINE TO ACCEPT THOSE TERMS, YOUR USE OF THE SOFTWARE WILL BE LIMITED. YOU ACKNOWLEDGE AND AGREE THAT CERTAIN CONTENT AND SERVICES AVAILABLE THROUGH THE SOFTWARE MAY BE PROVIDED BY THIRD PARTIES OVER WHICH SONY HAS NO CONTROL. USE OF THE CONTENT SERVICE REQUIRES AN INTERNET CONNECTION. THE CONTENT SERVICE MAY BE DISCONTINUED AT ANY TIME.

## **INTERNET CONNECTIVITY AND THIRD PARTY SERVICES**

You acknowledge and agree that access to certain SOFTWARE features may require an Internet connection for which you are solely responsible. Further, you are solely responsible for payment of any third party fees associated with your Internet connection, including but not limited to Internet service provider or airtime charges. Operation of the SOFTWARE may be limited or restricted depending on the capabilities, bandwidth or technical limitations of your Internet connection and service. The provision, quality and security of such Internet connectivity are the sole responsibility of the third party providing such service.

## **EXPORT AND OTHER REGULATIONS**

You agree to comply with all export and re-export restrictions and regulations of the Department of Commerce and other United States agencies and authorities, and not to transfer, or authorize the transfer, of the SOFTWARE to a prohibited country or otherwise in violation of any such restrictions or regulations.

## **U.S. GOVERNMENT RESTRICTED RIGHTS**

Use, duplication, or disclosure by the United States Government is subject to restriction as set forth in subparagraph (c) (1) and (2) of the Commercial Computer Software-Restricted Rights at 48 C.F.R. § 52.227-19, as applicable. The manufacturer solely for purposes of this section is Sony Electronics Inc., 16530 Via Esprillo, San Diego, CA 92127.

## **HIGH RISK ACTIVITIES**

The SOFTWARE is not fault-tolerant and is not designed, manufactured or intended for use or resale as on-line control equipment in hazardous environments requiring fail-safe performance, such as in the operation of nuclear facilities, aircraft navigation or communication systems, air traffic control, direct life support machines, or weapons systems, in which the failure of the SOFTWARE could lead to death, personal injury, or severe physical or environmental damage ("HIGH RISK ACTIVITIES"). SONY, each of the THIRD-PARTY SUPPLIERS, and each of their respective affiliates specifically disclaim any express or implied warranty, duty or condition of fitness for HIGH RISK ACTIVITIES.

## **EXCLUSION OF WARRANTY ON SOFTWARE**

You acknowledge and agree that use of the SOFTWARE is at your sole risk and that you are responsible for use of the SOFTWARE. The SOFTWARE is provided "AS IS," without warranty, duty or condition of any kind.

SONY AND EACH OF THE THIRD-PARTY SUPPLIERS (for purposes of this Section, SONY and each of the THIRD-PARTY SUPPLIERS shall be collectively referred to as "SONY") EXPRESSLY DISCLAIM ALL WARRANTIES, DUTIES OR CONDITIONS, EXPRESS OR IMPLIED, INCLUDING, BUT NOT LIMITED TO, THE IMPLIED WARRANTIES OF MERCHANTABILITY, NONINFRINGEMENT AND FITNESS FOR A PARTICULAR PURPOSE. SONY DOES NOT WARRANT OR MAKE ANY CONDITIONS OR REPRESENTATIONS (A) THAT THE FUNCTIONS CONTAINED IN ANY OF THE SOFTWARE WILL MEET YOUR REQUIREMENTS OR THAT THEY WILL BE UPDATED, (B) THAT THE OPERATION OF ANY OF THE SOFTWARE WILL BE CORRECT OR ERROR-FREE OR THAT ANY DEFECTS WILL BE CORRECTED, (C) THAT THE SOFTWARE WILL NOT DAMAGE ANY OTHER SOFTWARE, HARDWARE OR DATA, (D) THAT ANY SOFTWARE, NETWORK

SERVICES (INCLUDING THE INTERNET) OR PRODUCTS (OTHER THAN THE SOFTWARE) UPON WHICH THE SOFTWARE'S PERFORMANCE DEPENDS WILL CONTINUE TO BE AVAILABLE, UNINTERRUPTED OR UNMODIFIED, AND (E) REGARDING THE USE OR THE RESULTS OF THE USE OF THE SOFTWARE IN TERMS OF ITS CORRECTNESS, ACCURACY, RELIABILITY, OR OTHERWISE.

NO ORAL OR WRITTEN INFORMATION OR ADVICE GIVEN BY SONY OR AN AUTHORIZED REPRESENTATIVE OF SONY SHALL CREATE A WARRANTY, DUTY OR CONDITION OR IN ANY WAY INCREASE THE SCOPE OF THIS WARRANTY. SHOULD THE SOFTWARE PROVE DEFECTIVE YOU ASSUME THE ENTIRE COST OF ALL NECESSARY SERVICING, REPAIR OR CORRECTION. SOME JURISDICTIONS DO NOT ALLOW THE EXCLUSION OF IMPLIED WARRANTIES, SO THESE EXCLUSIONS MAY NOT APPLY TO YOU.

### **LIMITATION OF LIABILITY**

SONY AND EACH OF THE THIRD-PARTY SUPPLIERS (for purposes of this Section, SONY and each of the THIRD-PARTY SUPPLIERS shall be collectively referred to as "SONY") SHALL NOT BE LIABLE FOR ANY INCIDENTAL OR CONSEQUENTIAL DAMAGES FOR BREACH OF ANY EXPRESS OR IMPLIED WARRANTY, BREACH OF CONTRACT, NEGLIGENCE, STRICT LIABILITY OR UNDER ANY OTHER LEGAL THEORY RELATED TO THE SOFTWARE, INCLUDING, BUT NOT LIMITED TO, ANY DAMAGES ARISING OUT OF LOSS OF PROFITS, LOSS OF REVENUE, LOSS OF DATA, LOSS OF USE OF THE SOFTWARE OR ANY ASSOCIATED HARDWARE, DOWN TIME AND USER'S TIME, EVEN IF ANY OF THEM HAVE BEEN ADVISED OF THE POSSIBILITY OF SUCH DAMAGES. IN ANY CASE, EACH AND ALL OF THEIR AGGREGATE LIABILITY UNDER ANY PROVISION OF THIS EULA SHALL BE LIMITED TO THE AMOUNT ACTUALLY PAID FOR THE SOFTWARE. SOME JURISDICTIONS DO NOT ALLOW THE EXCLUSION OR LIMITATION OF INCIDENTAL OR CONSEQUENTIAL DAMAGES, SO THE ABOVE EXCLUSION OR LIMITATION MAY NOT APPLY TO YOU.

### **ENTIRE AGREEMENT, WAIVER, SEVERABILITY**

This EULA and SONY's privacy policy, each as amended and modified from time to time, together constitute the entire agreement between you and SONY with respect to the SOFTWARE. The failure of SONY to exercise or enforce any right or provision of this EULA shall not constitute a waiver of such right or provision. If any part of this EULA is held invalid, illegal, or unenforceable, that provision shall be enforced to the maximum extent permissible so as to maintain the intent of this EULA, and the other parts will remain in full force and effect. The United Nations Convention on Contracts for the International Sale of Goods shall not apply to the

SOFTWARE or this EULA. Furthermore, this EULA will not be governed or interpreted in any way by referring to any law based on the Uniform Computer Information Transactions Act (UCITA) or any other act derived from or related to UCITA.

### **BINDING ARBITRATION (ONLY FOR UNITED STATES RESIDENTS)**

**ANY "DISPUTE" THAT IS NOT RESOLVED THROUGH THE INFORMAL NEGOTIATION PROCESS DESCRIBED ABOVE SHALL BE RESOLVED EXCLUSIVELY THROUGH BINDING ARBITRATION.**

"DISPUTE" is defined as any disagreement, cause of action, claim, controversy, or proceeding between you and any Sony entity related to or arising out of the SOFTWARE or this EULA. DISPUTE is to be given the broadest possible meaning that will be enforced. If a DISPUTE arises, you agree to first give notice to SONY by contacting Sony Electronics Inc. at 16530 Via Esprillo, MZ 1105, San Diego, CA 92127, Attn: Legal Department, and engaging in good faith negotiations to attempt to resolve any DISPUTE for at least 14 days, except that you or Sony (or any of its affiliates) may skip this informal negotiation procedure for DISPUTE enforcing, protecting, or concerning the validity of intellectual property rights.

### **ARBITRATION INSTRUCTIONS (ONLY FOR UNITED STATES RESIDENTS)**

To begin arbitration, either you or SONY must make a written demand to the other for arbitration. The arbitration will take place before a single arbitrator. It will be administered in keeping with the Expedited Procedures of the Commercial Arbitration Rules, and the Supplementary Proceedings for Consumer-Related disputes when applicable ("Rules") of the American Arbitration Association ("AAA") in effect when the claim is filed. You may get a copy of AAA's Rules by contacting AAA at (800) 778-7879 or visiting [www.adr.org](http://www.adr.org). The filing fees to begin and carry out arbitration will be shared between you and SONY, but in no event shall your fees ever exceed the amount allowable by the special rules for Consumers Disputes provided for by AAA, at which point SONY will cover all additional administrative fees and expenses. This does not prohibit the arbitrator from giving the winning party their fees and expenses of the arbitration when appropriate pursuant to the Rules. Unless you and SONY agree differently, the arbitration will take place in the county and state where you live, and applicable federal or state law shall govern the substance of any DISPUTE. The Federal Arbitration Act, 9 U.S.C. § 1, et seq., will govern the arbitration itself and not any state law on arbitration. The arbitrator's decision will be binding and final, except for a limited right of appeal under the Federal Arbitration Act. The arbitrator may award declaratory or injunctive relief



only in favor of the party seeking relief, and only to the extent necessary to provide relief warranted by that party's individual claim. Any court with jurisdiction over the parties may enforce the arbitrator's decision.

### **SMALL CLAIMS EXCEPTION (ONLY FOR UNITED STATES RESIDENTS)**

Despite the provisions set forth above, you have the right to litigate any DISPUTE in small claims court or other similar court of limited jurisdiction, to the extent the amount at issue does not exceed \$15,000, and as long as such court has proper jurisdiction and all other requirements (including amount in controversy) are satisfied.

### **CLASS ACTION WAIVER (ONLY FOR UNITED STATES RESIDENTS)**

**YOU UNDERSTAND AND ACKNOWLEDGE THAT BY AGREEING TO BINDING ARBITRATION, YOU ARE GIVING UP THE RIGHT TO LITIGATE (OR PARTICIPATE IN AS A PARTY OR CLASS MEMBER) ANY DISPUTES IN COURT BEFORE A JUDGE OR JURY. ANY DISPUTE RESOLUTION PROCEEDING WILL BE CONDUCTED ONLY ON AN INDIVIDUAL BASIS, AND BOTH PARTIES AGREE NOT TO HAVE ANY DISPUTE HEARD AS A CLASS ACTION, REPRESENTATIVE ACTION, CONSOLIDATED ACTION, OR PRIVATE ATTORNEY GENERAL ACTION, UNLESS ALL PARTIES INVOLVED IN THE DISPUTE SPECIFICALLY AGREE TO DO SO IN WRITING FOLLOWING INITIATION OF THE ARBITRATION.**

### **OPT-OUT INSTRUCTIONS (ONLY FOR UNITED STATES RESIDENTS)**

IF YOU DO NOT WISH TO BE BOUND BY THE BINDING ARBITRATION PROVISION AND/OR THE CLASS ACTION WAIVER ABOVE, THEN: (1) YOU MUST NOTIFY SONY IN WRITING WITHIN 30 DAYS OF THE DATE THAT YOU FIRST USE THE SOFTWARE OR AGREE TO THIS EULA, WHICHEVER OCCURS FIRST; (2) YOUR WRITTEN NOTIFICATION MUST BE MAILED TO SONY ELECTRONICS INC., 16530 VIA ESPRILLO, MZ 1105, SAN DIEGO CA 92127, ATTN: LEGAL DEPARTMENT; AND (3) YOUR WRITTEN NOTIFICATION MUST INCLUDE: (A) YOUR NAME; (B) YOUR ADDRESS; (C) THE DATE YOU FIRST USED THE SOFTWARE OR AGREED TO THIS EULA; AND (D) A CLEAR STATEMENT THAT YOU DO NOT WISH TO RESOLVE DISPUTES WITH ANY SONY ENTITY THROUGH ARBITRATION AND/OR TO BE BOUND BY THE CLASS ACTION WAIVER.

### **REJECTING CHANGES MADE TO THE DISPUTE PROCEDURES (ONLY FOR UNITED STATES RESIDENTS)**

Despite anything to the contrary in this EULA, you may reject changes made to the binding arbitration provision and class action waiver if: (1) you've already begun authorized use of the SOFTWARE at the time the change was/is made; and (2) you mail written notice to the address in the immediately preceding paragraph within 30 days after the particular change was/is made. Should such a situation arise, you will still be bound by the DISPUTE procedures you previously agreed to and existing before the change you rejected was made.

### **MISCELLANEOUS (ONLY FOR UNITED STATES RESIDENTS)**

Any DISPUTE determined not subject to arbitration and not initiated in small claims court will be litigated by either party in a court of competent jurisdiction in either the superior court for the County of San Diego or in the United States District Court for the Southern District of California.

### **JURISDICTION, JURY TRIAL WAIVER (ONLY FOR CANADA RESIDENTS)**

The United Nations Convention on Contracts for the International Sale of Goods shall not apply to this EULA. Furthermore, this EULA will not be governed or interpreted in any way by referring to any law based on the Uniform Computer Information Transactions Act (UCITA) or any other act derived from or related to UCITA. This EULA, any disputes or claims arising out of or related to this EULA and your relationship with Sony under this EULA, shall be governed by and construed in accordance with the laws of the State of California, United States, without regard to its conflict of laws principles. Any and all disputes or claims arising out of or relating to this EULA or your relationship with SONY under this EULA shall be determined by arbitration in San Diego, California, before three (3) impartial arbitrators, in accordance with the laws of the State of California, United States, without regard to its conflict of laws principles. If you reside in the United States, the arbitration shall be administered by JAMS and the arbitrators shall be selected pursuant to the rules and procedures of JAMS. If you reside outside the United States, the arbitration shall be administered by ICC and the arbitrators shall be selected pursuant to the rules and procedures of ICC. The parties shall bear their own costs and expenses, including attorneys' fees, but the arbitrators may, in the award, allocate all of the administrative costs of the arbitration, including the fees of the arbitrators, against the party who did not prevail. The decision of the arbitrators shall be final and non-appealable. Judgment on any award may be entered in any court having competent

jurisdiction. EXCEPT TO THE EXTENT PROHIBITED BY LAW, SONY AND YOU EXPRESSLY WAIVE TRIAL BY JURY WITH RESPECT TO ANY MATTERS OR DISPUTES ARISING UNDER OR RELATING TO THIS EULA. Any claim or cause of action arising under this EULA must be commenced within one (1) year after the claim or cause of action arises.

## EQUITABLE REMEDIES

Notwithstanding anything contained in this EULA to the contrary, you acknowledge and agree that any violation of or non-compliance with this EULA by you will cause irreparable harm to SONY, for which monetary damages would be inadequate, and you consent to SONY obtaining any injunctive or equitable relief that SONY deems necessary or appropriate in such circumstances. SONY may also take any legal and technical remedies to prevent violation of and/or to enforce this EULA, including, but not limited to, immediate termination of your use of the SOFTWARE, if SONY believes in its sole discretion that you are violating or intend to violate this EULA. These remedies are in addition to any other remedies SONY may have at law, in equity or under contract.

## TERMINATION

Without prejudice to any of its other rights, SONY may terminate this EULA if you fail to comply with any of its terms. In case of such termination, you must: (i) cease all use, and destroy any copies, of the SOFTWARE; (ii) comply with the requirements in the section below entitled "Your Account Responsibilities".

## AMENDMENT

SONY RESERVES THE RIGHT TO AMEND ANY OF THE TERMS OF THIS EULA AT ITS SOLE DISCRETION BY POSTING NOTICE ON A SONY DESIGNATED WEB SITE, BY EMAIL NOTIFICATION TO AN EMAIL ADDRESS PROVIDED BY YOU, BY PROVIDING NOTICE AS PART OF THE PROCESS IN WHICH YOU OBTAIN UPGRADES/UPDATES OR BY ANY OTHER LEGALLY RECOGNIZABLE FORM OF NOTICE. If you do not agree to the amendment, you should promptly contact SONY for instructions. Your continued use of the SOFTWARE after the effective date of any such notice shall be deemed your agreement to be bound by such amendment.

## THIRD-PARTY BENEFICIARIES

Each THIRD-PARTY SUPPLIER is an express intended third-party beneficiary of, and shall have the right to enforce, each provision of this EULA with respect to the SOFTWARE of such party.

Should you have any questions concerning this EULA, you may contact SONY by writing to SONY at: Sony Electronics Inc., 16530 Via Esprillo, San Diego, CA 92127.

Copyright © 2020 Sony Electronics Inc. All rights reserved.

---

## Notice on license

This product contains software that Sony uses under a licensing agreement with the owner of its copyright. We are obligated to announce the contents of the agreement to customers under requirement by the owner of copyright for the software.

For details on software licenses, select [Settings] → [System] → [Open Source Licenses].

## Notice on GNU GPL/LGPL applied software

The software included in this product contains copyrighted software that is licensed under the GPLv2 and other licenses which may require access to source code. You may find a copy of the relevant source code as required under the GPLv2 (and other licenses) at

<http://www.sony.net/Products/Linux/>.

To download, please access the URL, then select the model name "XAV-AX8500."

You may obtain the source code as required by the GPLv2 on a physical medium from us for a period of three years after our last shipment of this product by applying through the form at <http://www.sony.net/Products/Linux/>.

This offer is valid to anyone in receipt of this information.

Please note that Sony cannot answer or respond to any inquiries regarding the content of the source code.

If you have any questions/problems regarding  
this product, try the following:

- 1** Read Troubleshooting in  
Help Guide (online manual).
- 2** Please contact (U.S.A. only);  
Call 1-800-222-7669  
URL <https://www.SONY.com>



In-Car Receiver  
XAV-AX8500



Use this manual if you encounter any problems, or have any questions.

Note: The unit sold in some countries/regions may differ from the picture above.

## Getting Started

### Guide to Parts and Controls

[Main Unit and Remote Commander](#)

[Screen Displays](#)

### [Performing Initial Settings](#)

### Using Apple CarPlay / Android Auto

[Using Apple CarPlay Wirelessly](#)

[Using Android Auto™ Wirelessly](#)

[Using Android Auto with a USB Cable](#)

### Preparing a BLUETOOTH Device

[Pairing and Connecting with a Bluetooth® Device](#)

[Connecting with a Paired BLUETOOTH Device](#)

---

## [Using Cameras](#)

### Smartphone Connection

[Apple CarPlay](#)

---

[Android Auto](#)

---

### Radio

#### Listening to the Radio

[Listening to the Radio](#)

---

[Tuning](#)

---

[Using Radio Option Functions](#)

---

#### Listening to the SiriusXM Radio (XAV-AX8500(UC))

[Listening to the SiriusXM Radio](#)

---

[Tuning Channels for SiriusXM](#)

---

[Tuning the Channel by Inputting its Channel Number](#)

---

[Tuning the Channel by TuneScan™](#)

---

[Tuning the Channel from the Channel List or Category List](#)

---

[Setting a Parental Control](#)

---

[Using SXM Option Functions](#)

---

### Playback

#### Playing a USB Device

[Playing a USB Device](#)

---

[Repeat Play and Shuffle Play](#)

---

[Searching for a File from the List Screen](#)

---

[Other Settings during Playback](#)

---

#### Playing an HDMI Device

[Playing an HDMI™ Device](#)

---

[Other Settings during Playback](#)

---

#### Playing a BLUETOOTH Device

[Playing a BLUETOOTH Device](#)

---

[Repeat Play and Shuffle Play](#)

## Handsfree Calling

[Preparing a Mobile Phone](#)

[Receiving a Call](#)

[Making a Call](#)

[Available Operations during a Call](#)

## iDataLink Maestro (XAV-AX8500(UC))

[Getting iDataLink Maestro Ready](#)

[Using iDataLink Maestro](#)

## Settings

[Basic Setting Operation](#)

[Device Connection](#)

[Sound](#)

[Customize](#)

[Application](#)

[System](#)

## Additional Information

[Canceling the Demonstration Mode](#)

[Sorting Apps on the Apps Area \(Favorite\)](#)

[Updating the Software](#)

[Precautions](#)

[Supported Formats for USB Playback](#)

[About iPhone](#)

[Notice on License](#)

[Maintenance](#)

[Specifications](#)

[Copyrights](#)

## Troubleshooting

## [Troubleshooting](#)

---

### General

- └ [There is no beep sound.](#)
  - └ [The fuse has blown. / The unit makes noise when the position of the ignition is switched.](#)
  - └ [The display disappears from the monitor. / The display does not appear on the monitor.](#)
  - └ [Menu items cannot be selected.](#)
  - └ [The unit cannot be operated.](#)
- 

### Display

- └ [The display does not turn on.](#)
- 

### Touch Screen

- └ [The touch screen does not react to your touch correctly.](#)
  - └ [Multi-touch is not recognized.](#)
- 

### Device Connection

- └ [A suffix such as "-2", "-3", .... appears after the name of the device on \[Device Connection\].](#)
- 

### Radio

- └ [The radio reception is poor. / Static noise occurs.](#)
  - └ [The stations cannot be received. \(XAV-AX8500\(E\)/XAV-AX8500\(E17\)/XAV-AX8500\(IN\)\).](#)
- 

### Picture

- └ [There is no picture or picture noise occurs.](#)
- 

### Sound

- └ [There is no sound, sound skips, or sound cracks.](#)
  - └ [Sound is noisy.](#)
- 

### USB playback

- └ [Items cannot be played.](#)
  - └ [The USB device takes longer to play.](#)
  - └ [The smartphone connected to the USB port cannot be played.](#)
- 

### HDMI playback

- └ [The connected HDMI device cannot be played.](#)
  - └ [HDMI playback stops.](#)
-

## BLUETOOTH

- └ [The other BLUETOOTH device cannot detect this unit.](#)
- └ [Connection is not possible.](#)
- └ [The name of the detected device does not appear.](#)
- └ [There is no ringtone.](#)
- └ [The talker's voice volume is low.](#)
- └ [The other party says that the volume is too low or high.](#)
- └ [Echo or noise occurs during call conversations.](#)
- └ [The phone sound quality is poor.](#)
- └ [The volume of the connected BLUETOOTH device or apps is low or high.](#)
- └ [The sound skips during audio streaming or the BLUETOOTH connection fails.](#)
- └ [The connected BLUETOOTH device cannot be controlled during audio streaming.](#)
- └ [Some functions do not work.](#)
- └ [A call is answered unintentionally.](#)
- └ [Pairing failed due to time out.](#)
- └ [Cannot pair.](#)
- └ [The BLUETOOTH function cannot be operated.](#)
- └ [No sound is output from the car speakers during a handsfree call.](#)

## SiriusXM Connect Vehicle Tuner (XAV-AX8500(UC))

- └ [A mature channel is not blocked although parental control setting has been made.](#)

## Apple CarPlay

- └ [The Apple CarPlay icon does not appear on the HOME screen.](#)
- └ [The position accuracy is not good when using maps with Apple CarPlay.](#)

## Android Auto

- └ [The Android Auto icon does not appear on the HOME screen.](#)
- └ [The position accuracy is not good when using maps with Android Auto.](#)

## iDataLink Maestro (XAV-AX8500(UC))

- └ [iDataLink Maestro](#)

## Messages



[General](#)

---

[SiriusXM Connect Vehicle Tuner \(XAV-AX8500\(UC\)\)](#)

## Support Websites

[Customer Support Websites](#)

---

[About the “Support by Sony” App](#)

5-050-133-11(1) Copyright 2023 Sony Corporation

In-Car Receiver  
XAV-AX8500

## Main Unit and Remote Commander

### Main unit

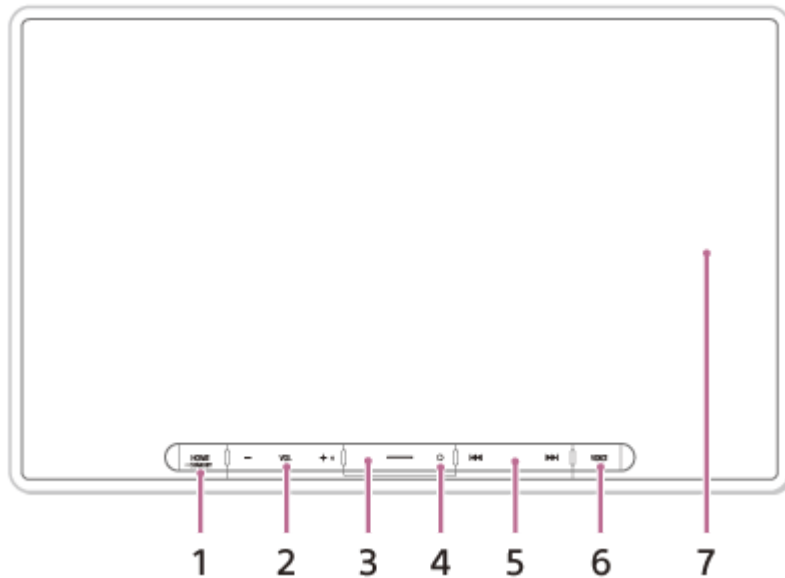

The VOL (volume) + button has a tactile dot.

### RM-X400 remote commander (XAV-AX8500(E)/XAV-AX8500(E17)/XAV-AX8500(IN))

The remote commander can be used to operate the audio controls. For menu operations, use the touch screen.

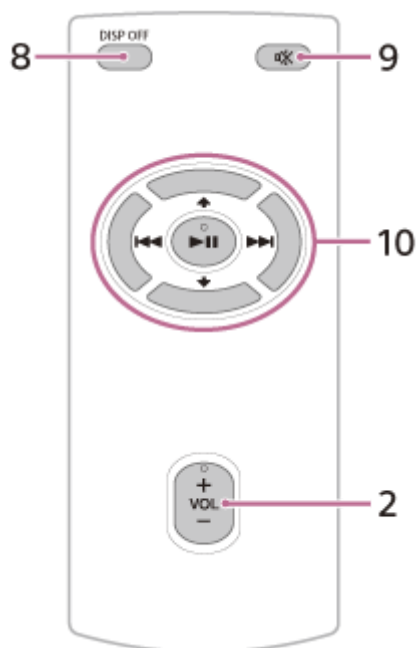

The VOL (volume) +/- (play/pause) buttons have a tactile dot.

### Note

- The **↑/↓** (up/down) buttons in the illustration above are not supported.

Remove the insulation film before use.

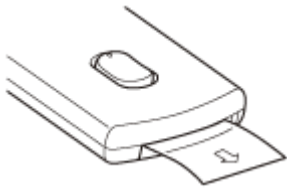

### Hint

- For XAV-AX8500(UC), the RM-X400 remote commander is available online at <https://encompass.com>.

## 1. HOME

Displays the HOME screen.

### ● **STANDBY**

Press and hold to turn off the unit.

Press and hold for more than 10 seconds to reset the unit.

## 2. VOL (volume) +/-

## 3. Custom

Registers functions (Mute, Disp. Off (display off), Source Change).

To register, select [Settings] → [Customize] → [Custom Button].

## 4. Receptor for the remote commander

## 5. ◀◀ / ▶▶ (previous/next)

Functions differently depending on the selected source:

[Radio]: select a preset station.

[SiriusXM]: select a preset channel. (XAV-AX8500(UC))

[USB]: move to the previous/next content.

[Bluetooth Audio]: move to the previous/next content.

[Apple CarPlay]/[Android Auto]: move to the previous/next content.

Press and hold to:

[Radio]: tune into a station automatically (SEEK+/SEEK-).

[USB]: fast-reverse/fast-forward.

[Bluetooth Audio]: fast-reverse/fast-forward.

## 6. VOICE

Activates the voice command function for Apple CarPlay and Android Auto.

## 7. Display/touch screen

## 8. DISP OFF (display off)

Turns off the display.

To turn back on, press again.

## 9. 🔇 (mute)

Mutes the sound. To cancel, press again.

## 10. ▶|| (play/pause)

### ◀◀ / ▶▶ (previous/next)

Functions differently depending on the selected source:

[Radio]: select a preset station.

[SiriusXM]: select a preset channel. (XAV-AX8500(UC))

[USB]: move to the previous/next content.

[Bluetooth Audio]: move to the previous/next content.

[Apple CarPlay]/[Android Auto]: move to the previous/next content.

Press and hold to:

[Radio]: tune into a station automatically (SEEK+/SEEK-).

[USB]: fast-reverse/fast-forward.

[Bluetooth Audio]: fast-reverse/fast-forward. Functions differ depending on the BLUETOOTH device.

---

---

### Related Topic

- [Screen Displays](#)

5-050-133-11(1) Copyright 2023 Sony Corporation

## Screen Displays

Playback screen:

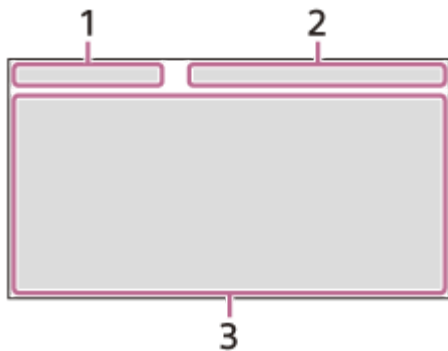

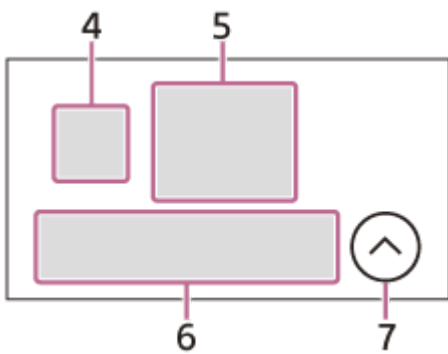

HOME1 screen:



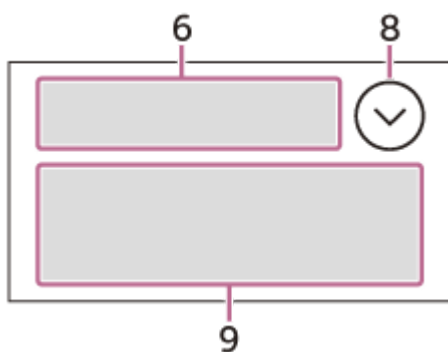



HOME2 screen:



### 1. Status indication (left side)

| Icon in the display   | Detail  |
|---|---|
| <br>(back) | Returns to the previous display.                                    |
| <br>(list) | Opens the list. The available lists differ depending on the source. |

### 2. Status indication (right side)

| Icon in the display  | Detail  |
|--|---|
| Clock  | Displays the time which was set on the Date/Time setting.                         |
| <br>(mute)    | Lights up when the sound is muted.  |
| <br>(option)  | Opens the source option menu. The available items differ depending on the source. |
| <br>(device)  | Displays the device's name to connect to the unit.                                |
| <br>(antenna) | Indicates the signal strength status of the connected mobile phone.               |
| <br>(battery) | Indicates the remaining battery status of the connected mobile phone.             |

### 3. Application specific area

Displays playback controls/indications or shows the unit's status. Displayed items differ depending on the source.

### 4. (Apple CarPlay)/ (Android Auto)

Displays when connecting Apple CarPlay/Android Auto.

### 5. Clock

Displays the date and time which were set on the Date/Time setting.

### 6. Apps area (Favorite)

Up to 5 Apps can be set. Apps can be changed. You can set your Favorite Apps.

### 7. All Apps

Opens the HOME2 screen.

### 8. Close







Returns to the HOME1 screen.













### 9. Apps area

Displays all Apps except for Favorite Apps.

### Apps icon list

XAV-AX8500(UC):

| Icon in the display   | Name          |
|---|---------------|
|  | Android Auto  |
|  | Apple CarPlay |
|  | Radio         |
|  | SiriusXM      |
|  | Bluetooth     |
|  | RearCam       |
|  | Settings      |













| Icon in the display   | Name                  |
|---|-----------------------|
|  | USB                   |
|  | HDMI                  |
|  | Camera 1              |
|  | Camera 2              |
|  | Phone                 |
|  | Devices               |
|  | Gauges *1*2           |
|  | Park Assist *1*2      |
|  | Vehicle Info *1*2     |
|  | Climate *1*2          |
|  | Satellite Radio*1*2*3 |
|  | Bluetooth Audio*1*2*3 |
|  | Media Player*1*2*3    |

\*1 When connecting the iDataLink Maestro module (not supplied), the icon is displayed.

\*2 Available functions differ according to your car type.

\*3 The display names differ according to your car type.

XAV-AX8500(E)/XAV-AX8500(E17)/XAV-AX8500(IN):

| Icon in the display   | Name           |
|---|----------------|
|  | Android Auto*  |
|  | Apple CarPlay* |
|  | Radio          |
|  | Bluetooth      |
|  | USB            |
|  | Phone          |
|  | Settings       |
|  | HDMI           |
|  | RearCam        |
|  | Camera 1       |
|  | Camera 2       |
|  | Devices        |

\* It may not be available in your country or region.

---

---

## Related Topic

- [System](#)
- [Sorting Apps on the Apps Area \(Favorite\)](#)

5-050-133-11(1) Copyright 2023 Sony Corporation





In-Car Receiver  
XAV-AX8500

## Performing Initial Settings

---

You need to perform initial settings before operating the unit for the first time, after replacing the car battery, or changing connections.

If the initial settings screen does not appear when you turn on the unit, perform the factory reset to initialize the unit.

- 1 Touch [Language], then set the display language.**  
To return to the previous display, touch  (back).
- 2 Touch [Demo Mode] repeatedly to select [Off] to disable the demonstration mode.**
- 3 Touch [Set Date/Time], then set the date and time.**  
To return to the previous display, touch  (back).
- 4 Touch [Radio Tuning Steps], then set the radio frequency depending on the receiving area. (XAV-AX8500(E)/XAV-AX8500(E17)/XAV-AX8500(IN))**
- 5 Touch [OK].**  
The startup caution appears.
- 6 Read through the startup caution, then if you accept all conditions, touch [Close].**  
The setting is complete.

This setting can be further configured in the setting menu.

---

### Related Topic

- [Device Connection](#)
- [Sound](#)
- [Customize](#)
- [Application](#)
- [System](#)

In-Car Receiver  
XAV-AX8500

## Using Apple CarPlay Wirelessly

When using Apple CarPlay for the first time, device registration (called “pairing”) is required. Pairing enables this unit and your iPhone to recognize each other.



### Note

- Make sure the GPS antenna (aerial) (supplied) is connected.

**1 Place your iPhone within 1 m (3 ft) of this unit.**

**2 Press HOME, then touch [Settings].**

If [Settings] is not set in the Favorite area, touch [All Apps] to display the HOME2 screen, then select [Settings].

### Hint

- You can touch [Devices] to open the [Device Connection] screen alternatively.

**3 Touch [Device Connection].**

**4 Touch [+Add New Device].**

**5 Operate your iPhone according to its message on the [Add New Device] screen.**

When setting the BLUETOOTH setting, Wi-Fi setting, and Apple CarPlay of your iPhone to [ON], select “XAV-AX8500” on the setting screen of your iPhone and then proceed to the pairing steps.

**6 [Pairing Request] appears on the unit.**

Confirm the [Passkey:].

The same 6-digit passkey appears on your iPhone and the unit.

**7 Touch [Pair], then touch [Apple CarPlay].**

### Note

- When pairing the unit with your iPhone via BLUETOOTH, the unit will not prompt you to enter a 6-digit passkey. If you are prompted to enter a passkey on your iPhone during pairing, it may be a passkey fraud by a malicious third party who intercepts the communication between your iPhone and the unit. We recommend that you pay close attention around the vicinity of your car and make sure that there are no untrustworthy third parties around you before starting pairing again.

- The unit can only be connected with one iPhone device at a time.
- To disconnect the BLUETOOTH connection, turn the connection off from either the unit or your iPhone.
- While using Apple CarPlay, BLUETOOTH connection is not possible. BLUETOOTH pairing is possible.
- When using Apple CarPlay, remove the HDMI cable from your iPhone. The HDMI connection is not possible while Apple CarPlay is running.
- Apple CarPlay may not be available in your country or region.

---

### Related Topic

- [Apple CarPlay](#)
- [Device Connection](#)

5-050-133-11(1) Copyright 2023 Sony Corporation

## Using Android Auto™ Wirelessly

When using Android Auto for the first time, device registration (called “pairing”) is required. Pairing enables this unit and an Android Auto compatible Android™ phone to recognize each other.



**1** Place your Android phone within 1 m (3 ft) of this unit.

**2** Press **HOME**, then touch **[Settings]**.

If **[Settings]** is not set in the Favorite area, touch **[All Apps]** to display the HOME2 screen, then select **[Settings]**.

**Hint**

- You can touch **[Devices]** to open the **[Device Connection]** screen alternatively.

**3** Touch **[Device Connection]**.

**4** Touch **[+Add New Device]**.

**5** Operate your Android phone according to its message on the **[Add New Device]** screen.

When setting the BLUETOOTH setting, Wi-Fi setting, and Android Auto of your Android phone to **[ON]**, select “XAV-AX8500” on the setting screen of your Android phone and then proceed to the pairing steps.

**6** **[Pairing Request]** appears on the unit.

Confirm the **[Passkey:]**.

The same 6-digit passkey appears on your Android phone and the unit.

**7** Touch **[Pair]**, then touch **[Start]**.

**Note**

- When pairing the unit with your Android phone via BLUETOOTH, the unit will not prompt you to enter a 6-digit passkey. If you are prompted to enter a passkey on your Android phone during pairing, it may be a passkey fraud by a malicious third party who intercepts the communication between your Android phone and the unit. We recommend that you pay close attention around the vicinity of your car and make sure that there are no untrustworthy third parties around you before starting a pairing again.
- The unit can only be connected with one Android phone at a time.
- To disconnect the BLUETOOTH connection, turn the connection off from either the unit or your Android phone.

- While using Android Auto, BLUETOOTH connection is not possible. BLUETOOTH pairing is possible.
- When using Android Auto, remove the HDMI cable from your Android phone. The HDMI connection is not possible while Android Auto is running.
- Android Auto may not be available in your country or region.

---

### Related Topic

- [Android Auto](#)
- [Device Connection](#)

5-050-133-11(1) Copyright 2023 Sony Corporation

In-Car Receiver  
XAV-AX8500

## Using Android Auto with a USB Cable

---

When using Android Auto with a USB cable, connect an Android Auto compatible Android phone to the unit with the USB cable.

### 1 Connect your Android phone to the USB port.

#### Note

- While using Android Auto, BLUETOOTH connection is not possible. BLUETOOTH pairing is possible.
- Android Auto may not be available in your country or region.

---

#### Related Topic

- [Android Auto](#)

In-Car Receiver  
XAV-AX8500

## Pairing and Connecting with a Bluetooth® Device

You can enjoy music or perform handsfree calling depending on the BLUETOOTH compatible device such as smartphones, mobile phones, and audio devices (hereafter “BLUETOOTH device” if not otherwise specified). For details on connecting, refer to the operating instructions supplied with the BLUETOOTH device. Before connecting the BLUETOOTH device, turn down the volume of this unit; otherwise, a loud sound may result.

When connecting a BLUETOOTH device for the first time, mutual registration (called “pairing”) is required. Pairing enables this unit and other BLUETOOTH devices to recognize each other.



**1** Place the BLUETOOTH device within 1 m (3 ft) of this unit.

**2** Press HOME, then touch [Settings].

If [Settings] is not set in the Favorite area, touch [All Apps] to display the HOME2 screen, then select [Settings].

### Hint

- You can touch [Devices] to open [Device Connection] alternatively.

**3** Touch [Device Connection].

**4** Touch [+Add New Device].

**5** Operate the BLUETOOTH device according to its message on the [Add New Device] screen.

When setting the BLUETOOTH setting of the BLUETOOTH device to [ON], select “XAV-AX8500” on the setting screen of your BLUETOOTH device and then proceed to the pairing steps.

**6** [Pairing Request] appears on the unit.

Confirm the [Passkey:].

The same 6-digit passkey appears on your BLUETOOTH device and the unit.

**7** Touch [Pair].

### Note

- When pairing the unit with your BLUETOOTH device via BLUETOOTH, the unit will not prompt you to enter a 6-digit passkey. If you are prompted to enter a passkey on your BLUETOOTH device during pairing, it may be a passkey fraud by a malicious third party who intercepts the communication between your BLUETOOTH device and the unit.

We recommend that you pay close attention around the vicinity of your car and make sure that there are no untrustworthy third parties around you before starting a pairing again.

- The unit can only be connected with one BLUETOOTH device at a time.
- To disconnect the BLUETOOTH connection, turn the connection off from either the unit or the BLUETOOTH device.
- BLUETOOTH connection is not possible while Apple CarPlay or Android Auto is running. BLUETOOTH pairing is possible on the [Device Connection] or [Add New Device] screen.
- When making a BLUETOOTH connection with your iPhone or Android phone, remove the HDMI cable from your iPhone or Android phone. The HDMI connection is not possible while using BLUETOOTH connection.

---

## Related Topic

- [Device Connection](#)

5-050-133-11(1) Copyright 2023 Sony Corporation



In-Car Receiver  
XAV-AX8500

## Connecting with a Paired BLUETOOTH Device

To use a paired BLUETOOTH device, connection with this unit is required. Some paired BLUETOOTH devices will connect automatically.



Activate the BLUETOOTH function on the BLUETOOTH device.

**1 Press HOME, then touch [Settings].**

If [Settings] is not set in the Favorite area, touch [All Apps] to display the HOME2 screen, then select [Settings].

**2 Touch [Device Connection].**

The list of paired BLUETOOTH devices appears.  
Select the BLUETOOTH device.

### To connect from the BLUETOOTH device

When setting the BLUETOOTH setting of the BLUETOOTH device to [ON], select “XAV-AX8500” on the setting screen of your BLUETOOTH device. Connection is made automatically.

### To connect the last-connected BLUETOOTH device from this unit

When the ignition is turned to on with the BLUETOOTH signal activated, this unit searches for the last-connected BLUETOOTH device, and connection is made automatically.

### To capture your voice during handsfree calling

You need to install the microphone (supplied).

#### To install the microphone (supplied)

Connect the microphone (supplied) to the MIC IN connector.  
For details, refer to “Operating Instructions” (supplied).



Set the connected microphone in your car.

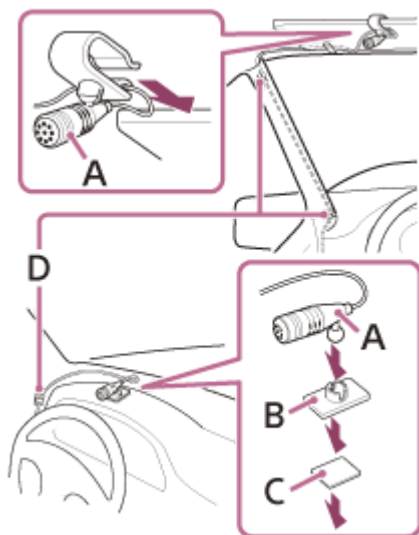

- A. Microphone (supplied)
- B. Flat-mount base (supplied)
- C. Double-sided tape (supplied)
- D. Clip (not supplied)

5-050-133-11(1) Copyright 2023 Sony Corporation

## Using Cameras

Connect the optional cameras to display the picture from the cameras.

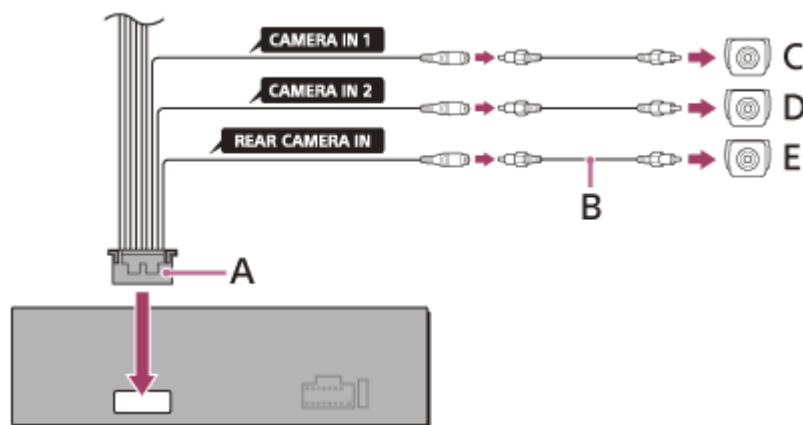

- A. Connection cables (Audio/Camera) (supplied)
- B. RCA pin cord (not supplied)
- C. Camera 1 (not supplied)
- D. Camera 2 (not supplied)
- E. Rear view camera (not supplied)

### To display the picture from the cameras

Connect the optional camera to the CAMERA IN 1 or CAMERA IN 2 cable to display the picture from the camera. Press HOME, then touch [Camera 1] or [Camera 2].

If [Camera 1] or [Camera 2] is not set in the Favorite area, touch [All Apps] to display the HOME2 screen, then select [Camera 1] or [Camera 2].

Connect the EXT IN 1 lead or EXT IN 2 lead to detect the interruption signal. The picture is automatically displayed from [Camera 1] or [Camera 2] when the interruption signal is detected. To cancel the interrupted picture of [Camera 1] and [Camera 2], touch ↶ (back).

### To display the picture from the rear view camera

Connect the optional rear view camera to the REAR CAMERA IN cable and connect the REVERSE IN lead to the 12 V power terminal of the car's rear lamp lead to display the picture from the rear view camera when the rear lights of your vehicle are illuminated (or the shift lever is set to the R (reverse) position).

Press HOME, then touch [RearCam].

If [RearCam] is not set in the Favorite area, touch [All Apps] to display the HOME2 screen, then select [RearCam].

### Note on the priority camera

[RearCam] always has priority. If both [Camera 1] and [Camera 2] occur at the same time, [Camera 1] has higher priority.

In-Car Receiver  
XAV-AX8500

## Apple CarPlay

---

Apple CarPlay lets you use your iPhone in the car in a way that allows you to stay focused on the road.

### Notes on using Apple CarPlay

- Check the Apple CarPlay website for supported iOS versions. Update to the latest iOS version before use.
- For details about Apple CarPlay, refer to the manual supplied with your iPhone, or visit the Apple CarPlay website.

#### 1 Connect your iPhone to the unit.

When your iPhone and the unit have already been paired, your iPhone and the unit are connected automatically.

#### 2 Press HOME, then touch [Apple CarPlay].

The Apple CarPlay interface will be displayed full-screen on the display of the unit. Touch and control the applications.

Use of the Apple CarPlay logo means that a vehicle user interface meets Apple performance standards. Apple is not responsible for the operation of this vehicle or its compliance with safety and regulatory standards. Please note that the use of this product with iPhone may affect wireless performance.

---

### Related Topic

- [Using Apple CarPlay Wirelessly](#)

In-Car Receiver  
XAV-AX8500

## Android Auto

---

Android Auto extends the Android platform into the car in a way that is purpose-built for driving.

### Notes on using Android Auto

- Check the Android Auto website for supported OS versions. Update to the latest OS version before use.
- Your Android phone needs to support Android Auto.
- Download the Android Auto app on Google Play.
- For details about Android Auto, refer to the manual supplied with your Android phone, or visit the Android Auto website.
- Android Auto may not be available in your country or region.

**1** Connect your Android phone to the unit.

**2** Press **HOME**, then touch **[Android Auto]**.

The Android Auto interface will be displayed full-screen on the display of the unit. Touch and control the applications.

---

### Related Topic

- [Using Android Auto™ Wirelessly](#)
- [Using Android Auto with a USB Cable](#)

## Listening to the Radio

Press HOME, then touch [Radio].

If [Radio] is not set in the Favorite area, touch [All Apps] to display the HOME2 screen, then select [Radio].

### Reception controls/indications

**Auto Tune:**

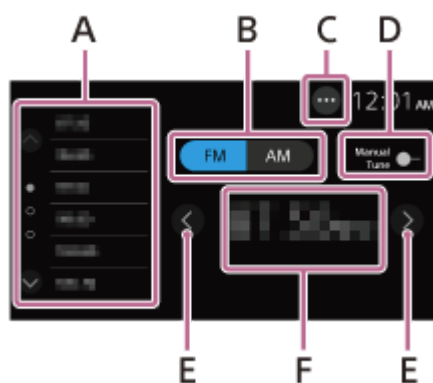

**Manual Tune:**

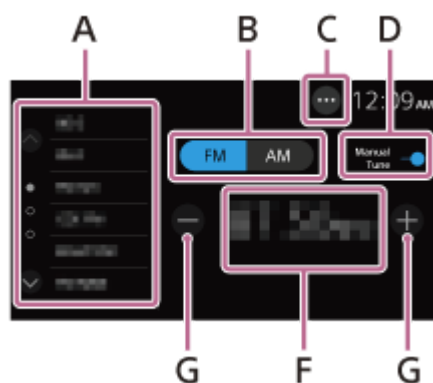

#### A. Preset area

Select a preset station.

Touch and hold to store the current frequency in that preset.

Touch  /  (up/down) to show the other preset stations.

#### B. Current band

Change the band (FM or AM).

#### C. ●●● (radio option)

Open the radio option menu.

#### D. Manual Tune

Switch the tuning between manually and automatically.

#### E. < / > (left/right)

Tune in automatically.

#### F. Current frequency, program service name\*, RDS (Radio Data System) indication\*

\* Only available during RDS reception.

**G. -/+**

Tune in manually.

Touch and hold to continuously skip frequencies.

5-050-133-11(1) Copyright 2023 Sony Corporation

## Tuning

---

**1** Select the desired band (FM or AM).

**2** Perform tuning.

### To tune automatically

Touch **</>** (left/right).

Scanning stops when the unit receives a station.

### To tune manually

Touch [Manual Tune] to switch the tuning manually.

Touch **-/+**.

Touch and hold **-/+** to continuously skip frequencies.

### To store manually

While receiving the station that you want to store, touch and hold the preset area.

### To receive stored stations

Select the band, then touch the desired preset station.

---

### Related Topic

- [Listening to the Radio](#)



In-Car Receiver  
XAV-AX8500

## Using Radio Option Functions

The following functions are available by touching ●●● (option) on the top-right of the screen.

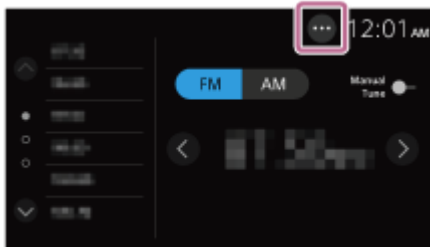

### [BTM (Best Tuning Memory)]

Stores stations in order of frequency on the preset numbers. 18 stations for FM and 12 stations for AM can be stored as preset stations.

### [Alternate Frequency] (XAV-AX8500(E)/XAV-AX8500(E17)/XAV-AX8500(IN))

Selects [On] to continuously retune the station to the strongest signal in a network.  
(Only available during FM reception.)

### [Regional Station Link] (XAV-AX8500(E)/XAV-AX8500(E17)/XAV-AX8500(IN))

Selects [On] to stay with the station you are receiving while the Alternate Frequency function is set to on. If you leave this regional program's reception area, select [Off]. This function does not work in the UK and some other areas.  
(Only available during FM reception.)

### [PTY]

Selects a program type from [Music] or [Talk] to search for a station broadcasting the selected program type.  
(Only available during FM reception.)

### To receive emergency announcements (XAV-AX8500(E)/XAV-AX8500(E17)/XAV-AX8500(IN))

With the Alternate Frequency function on, emergency announcements will automatically interrupt the currently selected source.

### Related Topic

- [Listening to the Radio](#)

In-Car Receiver  
XAV-AX8500

## Listening to the SiriusXM Radio

---

Press HOME, then touch [SiriusXM].

If [SiriusXM] is not set in the Favorite area, touch [All Apps] to display the HOME2 screen, then select [SiriusXM].

### To activate your SiriusXM Subscription

Only SiriusXM brings you more of what you love to listen to, all in one place. Get over 140 channels, including commercial-free music plus the best sports, news, talk, comedy and entertainment. Welcome to the world of satellite radio. A SiriusXM Connect Vehicle Tuner and Subscription are required. For more information, visit [www.siriusxm.com](http://www.siriusxm.com)

After installing your SiriusXM Connect Vehicle Tuner and antenna (aerial), press HOME, then touch [SiriusXM]. You should be able to hear the SiriusXM preview channel on Channel 1. After verifying that you can hear the preview channel, select Channel 0 to find the Radio ID of your radio. In addition, the Radio ID is located on the bottom of the SiriusXM Connect Vehicle Tuner and its packaging. You will need this number to activate your subscription. Write the number down for reference.

#### Note

- The SiriusXM Radio ID does not include the letters I, O, S or F.

### To display the SiriusXM Radio ID

1. Press HOME, then touch [SiriusXM].
2. Touch the channel number on the SiriusXM radio screen.
3. Input [000], then touch [OK].

In the USA, you can activate online or by calling SiriusXM Listener Care:

- Visit [www.siriusxm.com/activatenow](http://www.siriusxm.com/activatenow)
- Call SiriusXM Listener Care at 1-866-635-2349

For Canadian Subscriptions, please contact:

- Visit [www.siriusxm.ca/activate](http://www.siriusxm.ca/activate)
- Call SiriusXM Customer Care at 1-888-539-7474

As part of the activation process, the SiriusXM satellites will send an activation message to your radio. When your radio detects that the radio has received the activation message, your radio will display: [Subscription Updated. Press Enter to Continue.]. Once subscribed, you can tune to channels in your subscription plan.

#### Note

- The activation process usually takes 10 to 15 minutes, but may take up to an hour.
- Your radio will need to be turned on and receiving the SiriusXM signal to receive the activation message.



## Tuning Channels for SiriusXM

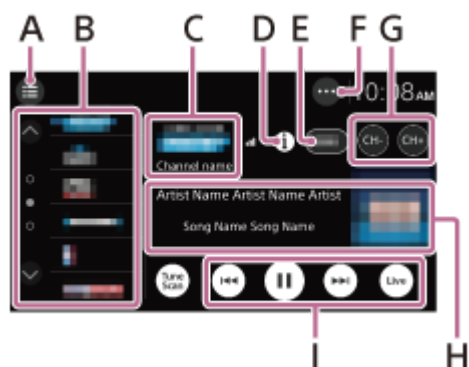

### Reception controls/indications



#### A. (list)

Open the channel list or category list.

#### B. Preset numbers

Select a preset channel. Touch  /  (up/down) to show the other preset channels. Touch and hold to store the current channel in that preset.

#### C. Channel logo, channel name

#### D. (information)

Switch the channel information in H.

#### E. Channel number

#### F. (SXM option)

Open the SXM option menu.

#### G. CH- (previous channel) /CH+ (next channel)

Select a channel.

#### H. Album art, artist name (category name), song title (content information)

#### I. (play) / (pause), (previous) / (next), (Live)

Each feature is compatible with SXV200 or later tuner models.

 (Live) is used to go back to live music/content.

You can reverse, forward, pause, and play by using the stored data while receiving the channel. During pause, [Replay Memory Full] may appear on the screen depending on the buffer.

Stored data will be erased when the ACC is OFF and the system is restarted.

## Tuning the Channel by Inputting its Channel Number

---

- 1 Touch the area with the channel number on the SiriusXM radio screen.

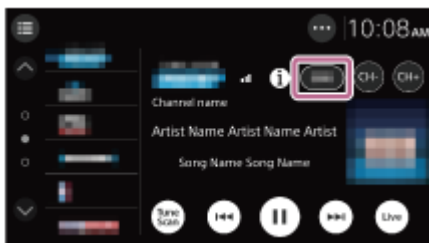

- 2 Input the channel number, then touch [OK].
- 

### Related Topic



- [Tuning Channels for SiriusXM](#)

In-Car Receiver  
XAV-AX8500

## Tuning the Channel by TuneScan™

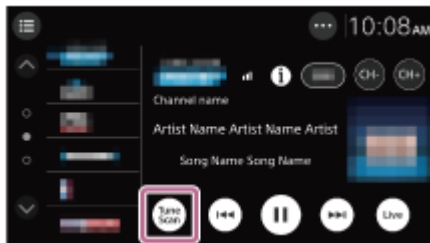
You can use the TuneScan feature to find your favorite music channel.



If you have multiple favorite music channels, you will have a lot of choices each time you tune. Instead of touching every preset channel and listening to the music, you can simply touch  (TuneScan) to get a short preview of music that you have missed on each of your preset music channels. (The six presets shown on the preset list and the currently tuned channel are previewed.) Find your favorite music and touch  (play) to continue listening to the music. You can skip backward or forward if you missed the preview, or you are not interested in the current preview.

### Note

- This feature is compatible with SXV200 or later tuner models.  
The number of music tracks for TuneScan depends on the SiriusXM tuner condition. TuneScan channels are comprised of preset channels, so it may take a few minutes after power on or preset page change to operate.

## Tuning the Channel from the Channel List or Category List

- 1 Touch  (list) on the SiriusXM radio screen.

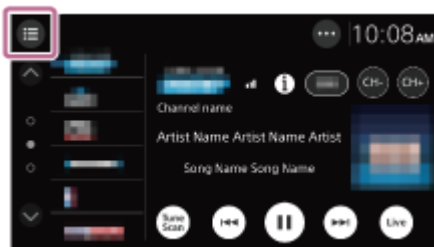

The category list appears.

- 2 Touch the desired category.  
To tune from the channel list, touch [All Channels].
- 3 Touch the desired channel.

## Setting a Parental Control

The parental control feature allows you to limit access to SiriusXM channels with mature content. When enabled, the parental control feature requires you to enter a passcode to tune to the locked channels. Information on setting up the passcode and locking channels can be found below.

- 1 Touch **•••** (option) on the SiriusXM radio screen, then touch **[Parental Control]**.

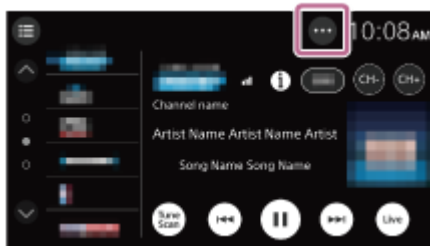

The passcode input display appears.

- 2 Enter your 4-digit passcode by touching the number keys, then touch **[OK]**.

The passcode confirmation display appears.

- 3 Enter the 4-digit passcode again, then touch **[OK]**.

The parental control is applied, and the channels are locked.

### To unlock the channels/To lock the channels again

1. Touch **•••** (option), then touch **[Parental Control]**.  
The passcode input display appears.
2. Enter your 4-digit passcode by touching the number keys, then touch **[OK]**.

### To change the passcode

1. Touch **•••** (option), touch **[Change Passcode]**, then enter your current passcode.
2. Enter your new passcode, then touch **[OK]**.  
The passcode confirmation display appears.
3. Enter your new passcode again, then touch **[OK]**.



In-Car Receiver  
XAV-AX8500

## Using SXM Option Functions

The following functions are available by touching ●●● (option) on the SiriusXM radio screen.



### [Parental Control]

Sets the parental lock to on or off.

### [Change Passcode]

Changes the passcode for the Parental Control feature.

### [TuneStart]

Switches the TuneStart™ feature on or off.

When turning the TuneStart feature on, you can listen to the beginning of the music when you tune to one of your preset channels. It may take a minute or two for the feature to work after power up or after changing preset pages.

### Note

- This feature is compatible with SXV200 or later tuner models.  
You may not listen to the beginning of the music depending on the SiriusXM tuner condition.

In-Car Receiver  
XAV-AX8500



## Playing a USB Device

MSC (Mass Storage Class) type USB devices\* compliant with the USB standard can be used.

\* e.g., a USB flash drive, digital media player

### Note

- Up to 25 000 files can be read for any type of file stored on a USB device.
- Store only the supported file formats for USB playback on a USB device.
- Check the supported file formats for USB playback.

- 1 **Turn down the volume on the unit.**
- 2 **Connect the USB device to the USB port.**
- 3 **Press HOME, then touch [USB].**  
If [USB] is not set in the Favorite area, touch [All Apps] to display the HOME2 screen, then select [USB].  
Playback starts.
- 4 **Touch  (audio) or  (video) to change the file type.**

### To remove the USB device

Turn the unit off or turn the ignition switch to the ACC off position, then remove the USB device.

### Related Topic

- [Supported Formats for USB Playback](#)
- [Customer Support Websites](#)

In-Car Receiver  
XAV-AX8500

## Repeat Play and Shuffle Play

---

- 1 During USB playback, touch  (repeat) or  (shuffle) repeatedly until the desired play mode appears.

Playback in the selected play mode may take time to start.



Available play modes differ depending on the selected sound source and connected device.

In-Car Receiver  
XAV-AX8500

## Searching for a File from the List Screen

---

- 1 During USB playback, touch  (list).**

The list screen of the currently played item appears.  
Touch  (audio) or  (video) to list up by file type.
- 2 Touch the desired item.**

Playback starts.

## Other Settings during Playback

---

When playing back a video, further settings are available by touching ●●● (option).

### Aspect

Selects an aspect ratio for the screen of the unit.

| Item     | Detail   |
|----------|--|
| Full     | Displays a 16:9 picture in its original size.  |
| Normal   | Displays a 4:3 picture in its original size, with side bars to fill the 16:9 screen. |
| Zoom     | Displays a 16:9 picture that has been converted into 4:3 letter box format.          |
| Captions | Enlarges the picture horizontally, while fitting captions in the screen.             |

In-Car Receiver  
XAV-AX8500

## Playing an HDMI™ Device

---

- 1 Turn off the HDMI device.
- 2 Turn down the volume on the unit.
- 3 Connect the HDMI device to the HDMI terminal on the unit.
- 4 Press HOME, then touch [HDMI].  
If [HDMI] is not set in the Favorite area, touch [All Apps] to display the HOME2 screen, then select [HDMI].
- 5 Turn on the HDMI device.  
Playback starts.

### Note

- When using the HDMI connection with your iPhone or Android phone, disconnect the BLUETOOTH connection, Apple CarPlay, and Android Auto.
- Do not disconnect the device during playback.
- To connect an Apple device via the HDMI cable, Lightning Digital AV Adapter or USB-C Digital AV Multiport Adapter is required.
- To charge a device when connecting the HDMI cable, connect to the USB port using a multiport adaptor.
- The supplied remote commander works for some of the operations on the unit. (XAV-AX8500(E)/XAV-AX8500(E17)/XAV-AX8500(IN))
- For HDMI connection, the supplied remote commander only works for this unit. (XAV-AX8500(E)/XAV-AX8500(E17)/XAV-AX8500(IN))
- The image may show up differently on the unit's display compared to the one on the display of the connected HDMI device.
- This unit is compatible with 480p, 576p, and 720p.

In-Car Receiver  
XAV-AX8500

## Other Settings during Playback

When playing back a video from an HDMI device connected to the HDMI terminal, further settings are available by touching ●●● (option).

### Picture EQ

Adjusts the picture quality according to your taste and stores them as custom setting: [Off], [Custom 1], [Custom 2].

 (register/setup) adjusts the contrast level and color level.

(Available only when the parking brake is applied.)

| Item     | Detail  |
|----------|---|
| Contrast | Adjusts the contrast level of the picture EQ: -10 to +10. |
| Color    | Adjusts the color level of the picture EQ: -10 to +10.    |

## Playing a BLUETOOTH Device

You can play contents on a connected device that supports BLUETOOTH A2DP (Advanced Audio Distribution Profile).



- 1 Make a BLUETOOTH connection with the BLUETOOTH device.**
- 2 Press HOME, then touch [Bluetooth].**  
If [Bluetooth] is not set in the Favorite area, touch [All Apps] to display the HOME2 screen, then select [Bluetooth].
- 3 Operate the BLUETOOTH device to start playback.**

### To match the volume level of the BLUETOOTH device to other sources

You can reduce the volume level differences between this unit and the BLUETOOTH device:  
During playback, touch **•••** (option), then set [Bluetooth Input Level] between -6 and +6.

#### Note

- Depending on the BLUETOOTH device, information such as title, track number/time, and playback status may not be displayed on this unit.
- Depending on the BLUETOOTH device or music playback application, audio output may distort when [Bluetooth Input Level] is set between +1 and +6. In this case, lower the [Bluetooth Input Level].
- BLUETOOTH connection is not possible while Apple CarPlay or Android Auto is running.

#### Related Topic

- [Connecting with a Paired BLUETOOTH Device](#)



In-Car Receiver  
XAV-AX8500

## Repeat Play and Shuffle Play

---

**1** During playback, touch  (repeat) or  (shuffle) repeatedly until the desired play mode appears.

Playback in the selected play mode may take time to start.

Available play modes differ depending on the selected sound source, connected device, and app.

In-Car Receiver  
XAV-AX8500

## Preparing a Mobile Phone

---

To use a mobile phone, connect it with this unit.



### Note

- The handsfree calling functions are not available when the Apple CarPlay or Android Auto function is activated. In this case, use the handsfree calling functions of the application.

---

### Related Topic

- [Pairing and Connecting with a Bluetooth® Device](#)
- [Connecting with a Paired BLUETOOTH Device](#)

## Receiving a Call

---

1 Touch  (call) when a call is received.

The phone call starts.

### Note

- The ringtone and talker's voice are output from the front speakers. To select the speakers for handsfree calling, press HOME, then touch [Settings] and select [Optional Audio Output Channel] in [System].

## To reject/end a call

Touch  (end a call).

---

## Related Topic

- [Preparing a Mobile Phone](#)

## Making a Call

### 1 Press HOME, then touch [Phone].

If [Phone] is not set in the Favorite area, touch [All Apps] to display the HOME2 screen, then select [Phone].

### 2 Touch one of the call icons on the BLUETOOTH phone display.

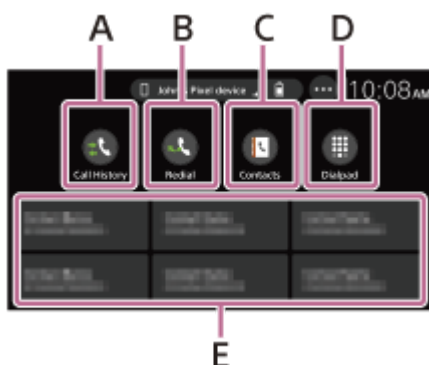

**A.** 📞 (Call History)\*

Select a contact from the call history list. The unit stores the last 20 calls.

**B.** 📞 (Redial)

Make a call automatically to the last contact you made.

**C.** 👤 (Contacts)\*

Select a contact from the name list/number list. To search for the desired contact in alphabetical order from the name list, touch 🔍 (Alphabetical Search).

**D.** 📞 (Dialpad)

Enter the phone number.

**E.** Favorites

Select the stored contact.

To store the contact, see "To add phone numbers to Favorites" below.

\* The mobile phone needs to support PBAP (Phone Book Access Profile).

### 3 Touch 📞 (call).

The phone call starts.

## To add phone numbers to Favorites

You can store up to 6 contacts in the Favorites.

1. On the phone screen, touch 👤 (Contacts) and select a phone number you want to store in the Favorites. The confirmation display appears.
2. Touch [Add to Favorites].
3. Touch the desired preset in the Favorites to store the phone number. The contact is stored in the Favorites.

### Note

- If the contact's name or phone number is too long, the string ends with "...".

---

---

## Related Topic

- [Preparing a Mobile Phone](#)

5-050-133-11(1) Copyright 2023 Sony Corporation

In-Car Receiver  
XAV-AX8500

## Available Operations during a Call

---

### To adjust the ringtone volume

Press VOL (volume) +/- while receiving a call.



### To adjust the talker's voice volume

Press VOL (volume) +/- during a call.

### To adjust the volume for the other party (Mic gain adjustment)

During a handsfree call, touch ●●● (option), then set [MIC Gain] to [High], [Middle], or [Low].

### To switch between handsfree mode and handheld mode

During a call, touch  ↔  (speaker/phone) to switch the phone call audio between the unit and mobile phone.

#### Note

- Depending on the mobile phone, this operation may not be available.

### To answer a receiving call automatically

Touch ●●● (option), then set [Auto Answer] to [On].

You cannot change the settings during a call or while making or receiving a call. It is required to be set in advance.

In-Car Receiver  
XAV-AX8500

## Getting iDataLink Maestro Ready

Connecting the iDataLink Maestro module (not supplied) to this unit allows you to display the current car status and adjust certain settings.

Available functions and settings differ according to your car type and the firmware installed to the iDataLink Maestro module. For more information, visit the following site:

<https://www.idatalinkmaestro.com/>

Sony does not guarantee all operations of the iDataLink Maestro functions and settings.

Installing the firmware to the iDataLink Maestro module is required before using the iDataLink Maestro features. Update to the latest firmware to use all available functions.

### 1 Check the serial number of the unit.

The serial number is indicated on the back of the unit, or touch [System Information] in [System].

### 2 Visit the website.

<https://www.idatalinkmaestro.com/>

Follow the on-screen instructions to configure the firmware according to your car type.

Enter the serial number.

### 3 Install the firmware to the iDataLink Maestro module.

If you have any questions or problems concerning the iDataLink Maestro module that are not covered on the website, contact:





Automotive Data Solutions Inc.

Email: [maestrosupport@adsdata.ca](mailto:maestrosupport@adsdata.ca)

Call: 1-866-427-2999

In-Car Receiver  
XAV-AX8500

## Using iDataLink Maestro

After installing the iDataLink Maestro module, only available functions and settings are displayed on the HOME screen:  
Ex.,  Climate,  Gauges,  Vehicle Info,  Park Assist

### Climate:

You can use this screen to see the status or control the climate control in your car.



### Gauges:

Displays driving information of your car, such as running speed and engine speed.



### Vehicle Info:

Displays information from your car, such as the tire pressure and car battery voltage.



### Park Assist:

Adds a visual display of detected objects to the existing parking sensor system in your car.

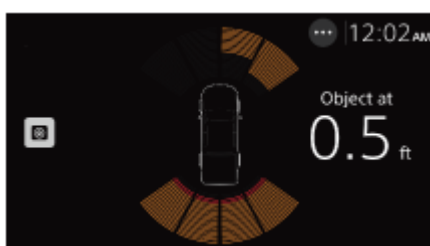

### Note on the obstacle detect information

This function is for supporting the driver's vision only, and not all obstacles and risks can be detected.





## Basic Setting Operation

---

You can set items in the following setup categories: Device Connection, Sound, Customize, Application, System.

**1 Press HOME, then touch [Settings].**

If [Settings] is not set in the Favorite area, touch [All Apps] to display the HOME2 screen, then select [Settings].

**2 Touch one of the setup category.**

The items that can be set differ depending on the source and settings.

**3 Touch the item you want to set.**

### To return to the previous display

Touch  (back).

---

### Related Topic

- [Device Connection](#)
- [Sound](#)
- [Customize](#)
- [Application](#)
- [System](#)
- [Canceling the Demonstration Mode](#)

In-Car Receiver  
XAV-AX8500

## Device Connection

---

### +Add New Device

- Connects and registers your device to the unit newly.
- Displays the name of the device connected to the unit. If the name of the connected device is duplicated, a suffix such as “-2”, “-3”, ... will appear after the name.
- You can switch the device by touching the name of the device you want to connect.
- When touching ⓘ, you can perform the following operations.
  - Delete the device by touching [Forget This Device].
  - Disconnect the device by touching [Disconnect].
  - When connecting an iPhone compatible with Apple CarPlay, you can switch between the BLUETOOTH connection and Apple CarPlay by touching [Change to Bluetooth] or [Change to Apple CarPlay].
  - When connecting an Android phone compatible with Android Auto, you can switch between the BLUETOOTH connection and Android Auto by touching [Switch to Bluetooth] or [Start Android Auto].

#### Note

- When pairing your BLUETOOTH device and the unit, be sure to open this setting.

---

### Related Topic

- [Basic Setting Operation](#)

## Sound

### EQ

Selects an equalizer curve.  
(Available when any source is selected.)

| Item           | Detail   |
|----------------|--|
| EQ             | <p>Selects the equalizer curve:</p> <p><b>XAV-AX8500(UC)</b><br/>[Off], [R&amp;B], [Rock], [Pop], [Dance], [Hip-Hop], [EDM], [Jazz], [Soul], [Country], [Custom 1], [Custom 2]</p> <p><b>XAV-AX8500(E)/XAV-AX8500(E17)</b><br/>[Off], [R&amp;B], [Rock], [Pop], [Dance], [Hip-Hop], [Jazz], [Soul], [Regueton], [Salsa], [Custom 1], [Custom 2]</p> <p><b>XAV-AX8500(IN)</b><br/>[Off], [Bollywood], [R&amp;B], [Rock], [Pop], [Dance], [Hip-Hop], [EDM], [Jazz], [Regueton], [Custom 1], [Custom 2]</p> |
| Edit Custom EQ | <p>Adjusts the equalizer curve from -12 to +12.<br/>When touching [EQ Adjust] of [EQ], [Edit Custom EQ] appears. The adjusted curve can be saved to [Custom 1] or [Custom 2] by touching [Save].</p>    |

### Subwoofer Level

Adjusts the volume level of the subwoofer: [Off], [On], -10 to +10.

### Balance/Fader

Adjusts the balance/fader level.

| Item    | Detail  |
|---------|---|
| Balance | Adjusts the sound balance between the left and right speakers: [L15] to [R15].          |
| Fader   | Adjusts the sound balance between the front and rear speakers: [Front 15] to [Rear 15]. |

### Listening Position

Selects the listening position: [Front Left], [Front Right], [Front], [All], [Off], [Custom].  
You can adjust the position of the sound image by correcting the arrival time of the sound according to the sitting position

of the car. When selecting [Custom], [Time Alignment] appears. You can adjust the distance from each speaker to the listening position in 0.1 inch or 1 cm increments (unit switchable) to correct the time it takes for the sound to reach the listening position.



## Crossover

Adjusts the cut-off frequency, slope, and subwoofer phase.

| Item             | Detail  |
|------------------|---|
| High Pass Filter | Adjusts the cut-off frequency of the front/rear speakers.   |
| Low Pass Filter  | Selects the cut-off frequency of the subwoofer.             |
| Slope            | Adjusts the slope of the front/rear speakers and subwoofer. |
| Phase            | Selects the subwoofer phase: [Normal], [Reverse].           |

## Related Topic

- [Basic Setting Operation](#)

In-Car Receiver  
XAV-AX8500

## Customize

---

### Custom Button

Registers functions: [Mute/Disp. Off], [Source Change].

### Wallpaper Select

Changes the wallpaper by touching the desired color or sets your favorite photo data in a MSC (Mass Storage Class) type USB device as a wallpaper.

(Available only when photo data are JPEG files of 6 MB or less with a pixel size of 2048 × 1080 or less.)

#### To set a photo data

When connecting the USB device to the USB port, touch [+] to display photos. Select your favorite photo, then touch [OK].

---

### Related Topic

- [Basic Setting Operation](#)

## Application

### Camera Display

Selects a camera view mode: [Normal], [Flipped].

[Rear Camera Guideline Adjust] displays the rear camera guidelines.

[Rear Camera Interruption] displays the video of the rear view camera connected to the REAR CAMERA IN cable when you put the gear shift in R (reverse).

[Camera 1 Interruption] automatically displays the video of the camera connected to the CAMERA IN 1 cable when the interruption signal is detected from the EXT IN 1 lead.

[Camera 2 Interruption] automatically displays the video of the camera connected to the CAMERA IN 2 cable when the interruption signal is detected from the EXT IN 2 lead.

### Notes on connecting the iDataLink Maestro module (not supplied) (XAV-AX8500(UC))

- When connecting the iDataLink Maestro module (not supplied) and you are using the interruption function from the module, [Rear Camera Interruption] is available. The Camera 1/Camera 2 interruption functions are set on [Maestro Settings] of [Application] in [Settings].
- When connecting the iDataLink Maestro module (not supplied) and you are using the Backup Camera Dynamic Guidelines function, adjust the guideline.

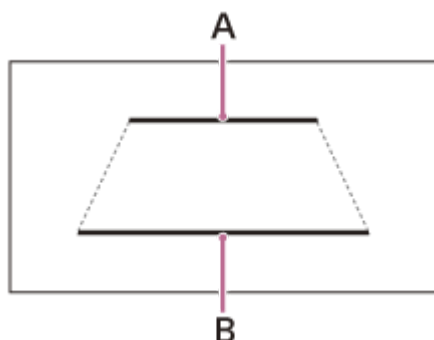

**A.** 2.0 m (6 1/2 feet) behind the car

**B.** 0.5 m (1 3/4 feet) behind the car

### SXM Reset (XAV-AX8500(UC))

Initializes the SiriusXM Connect Vehicle Tuner settings: [Reset], [Cancel].

### Maestro Input Level (XAV-AX8500(UC))

Adjusts the relative volume level to the signal input from the iDataLink Maestro module: -8 to +8.

(Available only when the connection with iDataLink Maestro is established.)

### Maestro Settings (XAV-AX8500(UC))

Displays the menus for your original car settings and setting for the iDataLink Maestro module. Your display will vary based on the firmware in the iDataLink Maestro module.

(Available only when the connection with iDataLink Maestro is established.)

## Radio Tuning Steps (XAV-AX8500(E)/XAV-AX8500(E17)/XAV-AX8500(IN))

Sets the FM/AM tuning step of your country or region.

---

---

### Related Topic

- [Basic Setting Operation](#)

5-050-133-11(1) Copyright 2023 Sony Corporation



In-Car Receiver  
XAV-AX8500

## System

### Language

Selects the display language: [Deutsch], [English], [Español], [Français], [Indonesian], [Italiano], [Nederlands], [Português], [Русский], [العربية], [简体中文], [繁體中文], [한국어].

### Date/Time

When receiving the GPS signal before setting [Date/Time], [Date/Time] is set automatically.

| Item        | Detail  |
|-------------|---|
| Date        | Sets the date: [Month], [Day], [Year].                        |
| Time        | Sets the clock time: [Hour], [Minute], [AM/PM].               |
| Date Format | Selects the format: [DD-MM-YYYY], [MM-DD-YYYY], [YYYY-MM-DD]. |
| Time Format | Selects the format: [12-Hour], [24-Hour].                     |

### Demo Mode

Activates or deactivates the demonstration.

### Steering Wheel Settings

Selects the input mode for the connected remote control. To prevent a malfunction, be sure to match the input mode with the connected remote control before use.

Set the [Custom] switch to [On].

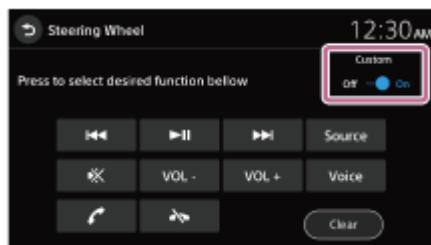

#### Note

- While making settings, the connected remote control cannot be used even though some functions have already been registered. Use the buttons on the unit.
- This function may not be available on some vehicles. For details on the compatibility of your vehicle, visit the support site.

### System Sound

Activates or deactivates the operation sound.

## Volume Settings

Adjusts the volume level of each source.

| Item                           | Detail  |
|--------------------------------|---|
| Media                          | Adjusts the volume of media: 0 to 50.   |
| Phone Call                     | Adjusts the volume of phone calls: 0 to 50.   |
| Ring Tone                      | Adjusts the volume of the ring tone: 0 to 50.   |
| Voice Recognition              | Adjusts the volume of voice recognition: 0 to 50.   |
| Maestro Chime (XAV-AX8500(UC)) | Adjusts the volume of Maestro chime: 0 to 50. (Available only when the connection with iDataLink Maestro is established.) |
| Navigation Guidance            | Adjusts the volume of navigation guidance from Apple CarPlay or Android Auto: 0 to 50.                                    |

### Note

- When adjusting the volume settings, park your car in a safe place as it may be too loud to hear the surrounding sounds.

## Optional Audio Output Channel

Selects the channels for call, guidance, and prompt audio: [Front], [Rear].

## Dimmer

Adjusts the brightness level of the display and buttons by changing the value.

When [Activate the set value with the vehicle's light] is on, the display and buttons turn on at this brightness level when the head lights are turned on.

## Key Illumination

Dims the button illumination: [Off], [On].

## Key Brightness on Display Off

Dims the button brightness when the monitor is turned off: [Off], [1], [2], [3], [4].

## Driver's Position

Selects the driving position to optimize usability of Apple CarPlay and Android Auto: [Left Side], [Right Side].

## MIC Adjust

Sets the microphone parameters according to the size of the car: [Small Cabin], [Medium Cabin], [Large Cabin].

## Bluetooth Signal

Activates the BLUETOOTH signal: [Off], [On].

## **Change PSK**

Changes the Wi-Fi pass key.

## **System Information**

Displays the system information: [Software Version], [Serial Number], [Wi-Fi Status], [Bluetooth Status], [GPS Status], [Speed Sensor Status].

## **Software Update**

Updates the software via USB flash drive or USB tethering.

## **Factory Reset**

Initializes all the settings to the factory settings.

## **Open Source Licenses**

Displays the software licenses.

---

---

### **Related Topic**

- [Basic Setting Operation](#)

5-050-133-11(1) Copyright 2023 Sony Corporation

In-Car Receiver  
XAV-AX8500

## Canceling the Demonstration Mode

---

**1** Press **HOME**, then touch **[Settings]**.

If **[Settings]** is not set in the Favorite area, touch **[All Apps]** to display the HOME2 screen, then select **[Settings]**.

**2** Touch **[System]**, then touch **[Demo Mode]** to set to **[Off]**.

**3** To exit the setup menu, touch  (back) twice.

---

### Related Topic

- [System](#)

## Sorting Apps on the Apps Area (Favorite)

Up to 5 Apps can be set on the Apps area (Favorite) of the HOME1 screen. Five Apps can be sorted.

Touch and hold the App you want to move, then drag it to the place you want to set it to.

Apps on the Apps area (Favorite) can be also changed to Apps on the Apps area except for those set to Favorite.

### HOME1 screen

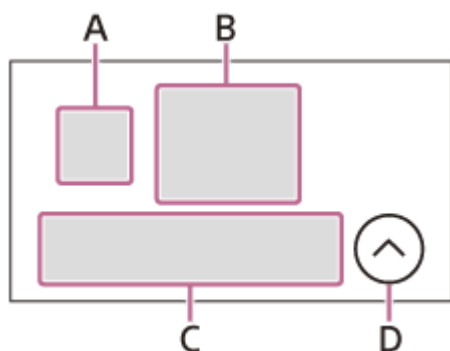

### HOME2 screen

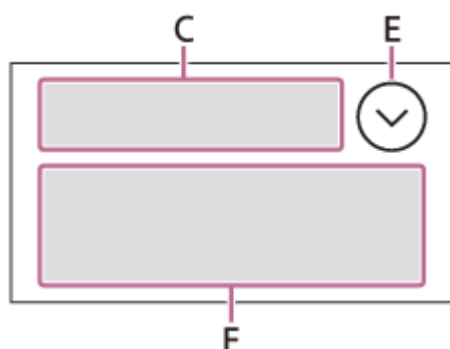

- A. (Apple CarPlay)/ (Android Auto)
- B. Clock
- C. Apps area (Favorite)
- D. All Apps
- E. Close
- F. Apps area (except for those set to Favorite)

### To change an App on the Apps area (Favorite)

- 1** Touch [All Apps] to open the HOME2 screen.  
The HOME2 screen opens.
- 2** Touch and hold the App to move from the Apps area (Favorite), then drag it to the Apps area (except for Favorite).  
A blank is created on the Apps area (Favorite).
- 3** Touch and hold the App to move to the App area (Favorite), then drag it on the blank space of the Apps area (Favorite).

#### 4 Touch [Close] to return to the HOME1 screen.

##### Note

- When you want to insert or move the App to the App area (Favorite), make sure the HOME2 screen opens. You cannot insert or move the Apps on the HOME1 screen.
- Apps on the Apps area (Favorite) are not aligned automatically. The blank between Apps is maintained.
- Apps except for the Apps area (Favorite) are aligned automatically. The blank between Apps is not created.

---

##### Related Topic

- [Screen Displays](#)

5-050-133-11(1) Copyright 2023 Sony Corporation

In-Car Receiver  
XAV-AX8500

## Updating the Software

---

To update the software, visit the support site, then follow the online instructions.

### To update the software with a USB flash drive

Download the software from the support site and save it in your USB flash drive. Connect your USB flash drive to the USB port, then follow the instructions on the screen of the unit.

### To update the software with USB tethering mode

When using the smartphone with tethering function, you can update the software with USB tethering mode. Connect your smartphone to the USB port, then follow the instructions on the screen of the unit.

#### Note

- During the update with a USB connection, do not disconnect the USB cable or USB device.
- A network connection may be required, and high packet communication fees may be incurred.

---

#### Related Topic

- [Customer Support Websites](#)

In-Car Receiver  
XAV-AX8500

## Precautions

---

- Power antenna (aerial) extends automatically.
- When you transfer ownership or dispose of your car with the unit installed, initialize all the settings to the factory settings by performing the factory reset.
- Do not splash liquid onto the unit.

## Notes on safety

- Comply with your local traffic rules, laws, and regulations.
- While driving
  - Do not watch or operate the unit, as it may lead to distraction and cause an accident. Park your car in a safe place to watch or operate the unit.
  - Do not use the setup feature or any other function which could divert your attention from the road.
  - When backing up your car, be sure to look back and watch the surroundings carefully for your safety even if the rear view camera is connected. Do not depend on the rear view camera exclusively.
- While operating
  - Do not insert your hands, fingers, or foreign objects into the unit as it may cause injury or damage to the unit.
  - Keep small articles out of the reach of children.
  - Be sure to fasten seatbelts to avoid injury in the event of sudden movement of the car.

## Preventing an accident

Do not operate the unit or watch the monitor while driving.

Pictures appear only after you park the car and set the parking brake. If the car starts moving during video playback, the following caution is displayed and you cannot watch the video.

### [Video blocked for your safety]

## Notes on LCD panel

- Do not get the LCD panel wet or expose it to liquids. This may cause a malfunction.



- Do not press down hard on the LCD panel as doing so can distort the picture or cause a malfunction (i.e., the picture may become unclear or the LCD panel may be damaged).
- Do not touch the panel with objects other than with your finger as it may damage or break the LCD panel.
- Clean the LCD panel with a dry soft cloth. Do not use solvents such as benzene, thinner, commercially available cleaners, or antistatic spray.
- Do not use the unit outside the temperature range 0 °C to 40 °C (32 °F to 104 °F).
- If your car was parked in a cold or hot place, the picture may not be clear. However, the monitor is not damaged and the picture will become clear after the temperature in your car becomes normal.



- Some stationary blue, red, or green dots may appear on the monitor. These are called “bright spots” and can happen with any LCD. The LCD panel is precision-manufactured with more than 99.99% of its segments functional. However, it is possible that a small percentage (typically 0.01%) of the segments may not light up properly. This will not, however, interfere with your viewing.

### **Notes on the touch screen**

- This unit uses a capacitive touch screen. Touch the screen directly with your fingertip.
- Multi-touch operation is not supported on this unit.
- Do not touch the screen with sharp objects such as a needle, pen, or fingernail. Operation with a stylus is not supported on this unit.
- Touching the screen with a gloved finger may cause the unit to operate incorrectly or not respond.
- Do not let any objects contact the touch screen. If the screen is touched by an object other than your fingertip, the unit may not respond correctly.
- Since glass material is used for the screen, do not subject the unit to strong shock. If cracking or chipping occurs on the screen, do not touch the damaged part as it may cause injury.
- Keep other electrical devices away from the touch screen. They may cause the touch screen to malfunction.
- If there are water droplets on the touch screen, or if you touch the screen with wet fingertips, the touch screen may not react correctly.

### **Internet connection and IP address**

Technical data such as IP address (or device details) is used when this product is connected to the internet for software update or receiving third party services. For software updates, these technical data may be communicated to our update servers in order to provide you with the software update appropriate to your device. If you do not want such technical data be used at all, do not set-up the wireless internet function and do not connect an internet cable.

If you have any questions or problems concerning your unit that are not covered in this Help Guide, consult your nearest Sony dealer.

In-Car Receiver  
XAV-AX8500

## Supported Formats for USB Playback

---

### Audio:

#### **WMA (.wma)\*<sup>1</sup> \*<sup>2</sup>**

Bit rate: 32 kbps – 192 kbps (Supports variable bit rate (VBR))\*<sup>3</sup>  
Sampling frequency\*<sup>4</sup>: 44.1 kHz  
Channel number: 2ch

#### **MP3 (.mp3)\*<sup>1</sup> \*<sup>2</sup>**

Bit rate: 32 kbps – 320 kbps (Supports variable bit rate (VBR))\*<sup>3</sup>  
Sampling frequency\*<sup>4</sup>: 32 kHz, 44.1 kHz, 48 kHz  
Channel number: 2ch

#### **AAC (.m4a)\*<sup>1</sup> \*<sup>2</sup>**

Bit rate: 16 kbps – 320 kbps (Supports variable bit rate (VBR))\*<sup>3</sup>  
Sampling frequency\*<sup>4</sup>: 8 kHz – 48 kHz  
Channel number: 2ch

#### **ALAC (.m4a)\*<sup>1</sup> \*<sup>5</sup>**

Sampling frequency\*<sup>4</sup>: 8 kHz – 384 kHz  
Bit per sample (Quantization bit): 16 bits, 24 bits  
Channel number: 2ch

#### **FLAC (.flac)\*<sup>1</sup>**

Sampling frequency\*<sup>4</sup>: 8 kHz – 384 kHz  
Bit per sample (Quantization bit): 16 bits, 24 bits  
Channel number: 2ch

#### **WAV (.wav)\*<sup>1</sup>**

Sampling frequency\*<sup>4</sup>: 8 kHz – 768 kHz  
Bit per sample (Quantization bit): 16 bits, 24 bits, 32 bits  
Channel number: 2ch

#### **DSD (.dsf/.dff)\*<sup>6</sup>**

Sampling frequency: 2.8 MHz, 5.6 MHz, 11.2 MHz, 22.4 MHz  
Channel number: 2ch

### Video:

#### **ASF (.asf) / WMV (.wmv)**

Video codec: VC-1 Simple/Main/Advanced Profile  
Audio codec: WMA  
Bit rate: Max. 5 Mbps  
Frame rate: Max. 30 fps  
Resolution: Max. 1280 × 720

#### **AVI (.avi) / MKV (.mkv) / MPEG-4 (.mp4)**

- Video codec: AVC Baseline/Main/High Profile  
Audio codec: MP3, AAC  
Bit rate: Max. 30 Mbps  
Frame rate: Max. 30 fps  
Resolution: Max. 1920 × 1080
- Video codec: MPEG-4 Advanced Simple Profile  
Audio codec: MP3, AAC  
Bit rate: Max. 20 Mbps  
Frame rate: Max. 30 fps  
Resolution: Max. 1280 × 720

\*1 Copyright-protected files and multi-channel audio files cannot be played back.

\*2 DRM (Digital Rights Management) files cannot be played back.

\*3 Non-standard bit rates or non-guaranteed bit rates are included depending on the sampling frequency.

\*4 Sampling frequency may not correspond to all encoders.

\*5 Displaying the tag information is not supported.

\*6 Converted to PCM internally (192 kHz).

### Note

- Not all files of the above file formats can be played back on the unit.
- AVCHD format is not supported.

In-Car Receiver  
XAV-AX8500

## About iPhone

---

- **Compatible iPhone models:**

iPhone SE (3rd generation), iPhone 13 Pro Max, iPhone 13 Pro, iPhone 13, iPhone 13 mini, iPhone 12 Pro Max, iPhone 12 Pro, iPhone 12, iPhone 12 mini, iPhone SE (2nd generation), iPhone 11 Pro Max, iPhone 11 Pro, iPhone 11, iPhone XS Max, iPhone XS, iPhone XR, iPhone X, iPhone 8 Plus, iPhone 8, iPhone 7 Plus, iPhone 7, iPhone SE, iPhone 6s Plus, iPhone 6s, iPhone 6 Plus, iPhone 6, iPhone 5s

- Use of the Made for Apple badge means that an accessory has been designed to connect specifically to the Apple product(s) identified in the badge, and has been certified by the developer to meet Apple performance standards. Apple is not responsible for the operation of this device or its compliance with safety and regulatory standards. Please note that the use of this accessory with an Apple product may affect wireless performance.
- Check the Apple CarPlay website for supported iOS versions. Update to the latest iOS version before use.

In-Car Receiver  
XAV-AX8500

## Notice on License

---

This product contains software that Sony uses under a licensing agreement with the owner of its copyright. We are obligated to announce the contents of the agreement to customers under requirement by the owner of copyright for the software. For details on software licenses, select [Settings] → [System] → [Open Source Licenses].

### Notice on GNU GPL/LGPL applied software

The software included in this product contains copyrighted software that is licensed under the GPLv2 and other licenses which may require access to source code. You may find a copy of the relevant source code as required under the GPLv2 (and other licenses) at

<http://www.sony.net/Products/Linux/>.

To download, please access the URL, then select the model name "XAV-AX8500". You may obtain the source code as required by the GPLv2 on a physical medium from us for a period of three years after our last shipment of this product by applying through the form at

<http://www.sony.net/Products/Linux/>.

This offer is valid to anyone in receipt of this information.

Please note that Sony cannot answer or respond to any inquiries regarding the content of the source code.

---

### Related Topic

- [System](#)

In-Car Receiver  
XAV-AX8500

## Maintenance

### Replacing the lithium battery (CR2025) of the remote commander (XAV-AX8500(E)/XAV-AX8500(E17)/XAV-AX8500(IN))

When the battery becomes weak, the range of the remote commander becomes shorter.

#### CAUTION

Danger of explosion if battery is incorrectly replaced. Replace only with the same or equivalent type.

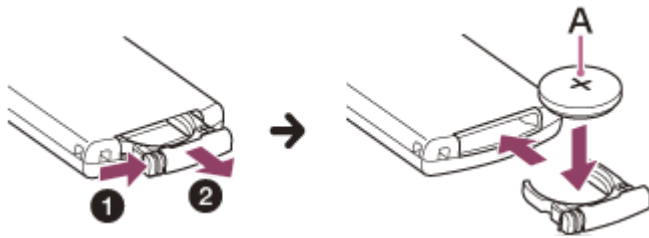

A: Lithium battery (CR2025) + side up

#### Note

- Keep the lithium battery out of the reach of children. Should the battery be swallowed, immediately consult a doctor.

In-Car Receiver  
XAV-AX8500

## Specifications

FOR THE CUSTOMERS IN THE USA. NOT APPLICABLE IN CANADA, INCLUDING IN THE PROVINCE OF QUEBEC.

POUR LES CLIENTS AUX ÉTATS-UNIS. NON APPLICABLE AU CANADA, Y COMPRIS LA PROVINCE DE QUÉBEC.

### AUDIO POWER SPECIFICATIONS



CTA2006 Standard

Continuous Power Output: 20 W RMS × 4 Channels at 4 Ω and ≤ 1% THD+N

Signal to Noise: 85 dBA reference 1 Watt RMS

### Monitor section

|                  |   |
|------------------|---|
| Display type     | Wide LCD color monitor                  |
| Dimensions       | 25.7 cm/ 10.1 in                        |
| System           | TFT active matrix                       |
| Number of pixels | 2 764 800 pixels (1280 × 3 (RGB) × 720) |

### Radio section

**XAV-AX8500(UC):**

#### FM

|                       |                      |
|-----------------------|----------------------|
| Tuning range          | 87.5 MHz — 107.9 MHz |
| Usable sensitivity    | 7 dBf                |
| Signal-to-noise ratio | 70 dB (mono)         |
| Separation at 1 kHz   | 45 dB                |

#### AM

|              |                     |
|--------------|---------------------|
| Tuning range | 530 kHz — 1 710 kHz |
| Sensitivity  | 32 μV               |

**XAV-AX8500(E)/XAV-AX8500(E17)/XAV-AX8500(IN):**

**FM**

|                       |   |
|-----------------------|---|
| Tuning range          | 87.5 MHz — 108.0 MHz (at 50 kHz step)<br>87.5 MHz — 108.0 MHz (at 100 kHz step) |
| FM tuning step        | 50 kHz/100 kHz switchable   |
| Usable sensitivity    | 7 dBf   |
| Signal-to-noise ratio | 70 dB (mono)  |
| Separation at 1 kHz   | 45 dB   |

**AM**

|                |   |
|----------------|---|
| Tuning range   | 531 kHz — 1 602 kHz (at 9 kHz step)<br>530 kHz — 1 710 kHz (at 10 kHz step) |
| AM tuning step | 9 kHz/10 kHz switchable   |
| Sensitivity    | 32 $\mu$ V  |

**USB player section**

|                 |                        |
|-----------------|------------------------|
| Interface       | USB Type-C® (Hi-speed) |
| Maximum current | USB port: 3.0 A        |

**HDMI section\***

|              |                  |
|--------------|------------------|
| Input format | 480p, 576p, 720p |
|--------------|------------------|

\* HDMI output is not available.

**BLUETOOTH section**

|   |   |
|---|---|
| Communication System                        | BLUETOOTH Standard version 5.0  |
| Output                                      | BLUETOOTH Standard Power Class 1 (Max. Conducted +7.5 dBm)  |
| Maximum communication range* <sup>1</sup>   | Line of sight approx. 10 m (33 ft)  |
| Frequency band                              | 2.4 GHz band (2.400 0 GHz — 2.483 5 GHz)  |
| Modulation method                           | FHSS  |
| Compatible BLUETOOTH Profiles* <sup>2</sup> | A2DP (Advanced Audio Distribution Profile) 1.3.1<br>AVRCP (Audio Video Remote Control Profile) 1.6.1<br>HFP (Handsfree Profile) 1.7.1<br>PBAP (Phone Book Access Profile) 1.2 |
| Corresponding codec                         | SBC, AAC, LDAC™   |



\*1 The actual range will vary depending on factors such as obstacles between devices, magnetic fields around a microwave oven, static electricity, reception sensitivity, antenna (aerial) performance, operating system, software application, etc.

\*2 BLUETOOTH standard profiles indicate the purpose of BLUETOOTH communication between devices.

## Wi-Fi section

### XAV-AX8500(UC):

|                      |                                    |
|----------------------|------------------------------------|
| Compatible standards | IEEE802.11 a/n/ac                  |
| Radio frequency      | 5 GHz band (5.725 GHz — 5.850 GHz) |
| Output power         | Max. conducted 16 dBm              |
| Frequency Tolerance  | 20 ppm                             |

### XAV-AX8500(E):

|                      |                                      |
|----------------------|--------------------------------------|
| Compatible standards | IEEE802.11 b/g/n                     |
| Radio frequency      | 2.4 GHz band (2.401 GHz — 2.473 GHz) |
| Output power         | Max. conducted 18 dBm                |
| Frequency Tolerance  | 20 ppm                               |

### XAV-AX8500(E17)/XAV-AX8500(IN):

|                      |                                    |
|----------------------|------------------------------------|
| Compatible standards | IEEE802.11 a/n/ac                  |
| Radio frequency      | 5 GHz band (5.725 GHz — 5.850 GHz) |
| Output power         | Max. conducted 10 dBm              |
| Frequency Tolerance  | 20 ppm                             |

## Power amplifier section

|                      |                   |
|----------------------|-------------------|
| Outputs              | Speaker outputs   |
| Speaker impedance    | 4 Ω — 8 Ω         |
| Maximum power output | 55 W × 4 (at 4 Ω) |

## General

|                           |   |
|---------------------------|---|
| Power requirements        | 12 V DC car battery (negative ground (earth)) |
| Rated current consumption | 10 A  |

|                                |  |
|--------------------------------|--|
| Dimensions (maximum)           | Approx. 269 mm × 167 mm × 263 mm (10 5/8 in × 6 5/8 in × 10 3/8 in) (w/h/d)  |
| Mounting dimensions            | Approx. 178 mm × 50 mm × 158 mm (7 in × 2 in × 6 1/4 in) (w/h/d)   |
| Mass                           | Approx. 2.6 kg (5 lb 12 oz)  |
| Package contents               | Main unit (1)<br>Parts for installation and connections (1 set)<br>Remote commander (1): RM-X400 (XAV-AX8500(E)/XAV-AX8500(E17)/XAV-AX8500(IN))  |
| Optional accessories/equipment | Remote commander: RM-X400 (XAV-AX8500(UC))<br>SiriusXM Connect Vehicle Tuner*: SXV100, SXV200, SXV300 (XAV-AX8500(UC))<br>iDataLink Maestro RR module, iDataLink Maestro RR2 module (XAV-AX8500(UC)) |

\* Some features are compatible with SXV200 or later tuner models.

Ask the dealer for detailed information.

Design and specifications are subject to change without notice.

5-050-133-11(1) Copyright 2023 Sony Corporation

In-Car Receiver  
XAV-AX8500

## Copyrights

---



SiriusXM-Ready® allows you to Listen to ad-free music, plus all the sports, talk, comedy, news coverage, all in one place. (SiriusXM Connect Tuner and subscription required. Sold separately.)

For more information, visit [www.siriusxm.com](http://www.siriusxm.com).

SiriusXM and all related marks and logos are trademarks of Sirius XM Radio, Inc. All rights reserved.

The Bluetooth® word mark and logos are registered trademarks owned by Bluetooth SIG, Inc. and any use of such marks by Sony Group Corporation and its subsidiaries is under license. Other trademarks and trade names are those of their respective owners.

Windows Media is either a registered trademark or trademark of Microsoft Corporation in the United States and/or other countries.

This product is protected by certain intellectual property rights of Microsoft Corporation. Use or distribution of such technology outside of this product is prohibited without a license from Microsoft or an authorized Microsoft subsidiary.

Apple, iPhone, and Apple CarPlay are trademarks of Apple Inc., registered in the U.S. and other countries.

IOS is a trademark or registered trademark of Cisco in the U.S. and other countries and is used under license.

Google, Android, Google Play and Android Auto are trademarks of Google LLC.

To use Android Auto on your car display, you'll need an Android phone running Android 8 or higher, an active data plan, and the Android Auto app.

To wirelessly use Android Auto on your car display, you need a compatible Android smartphone with an active data plan. You can check which smartphones are compatible at [g.co/androidauto/requirements](http://g.co/androidauto/requirements).

The Wi-Fi CERTIFIED™ Logo is a certification mark of Wi-Fi Alliance®.

LDAC and LDAC logo are trademarks of Sony Corporation.

USB Type-C® and USB-C® are registered trademarks of USB Implementers Forum.

The terms HDMI, HDMI High-Definition Multimedia Interface, HDMI Trade dress and the HDMI Logos are trademarks or registered trademarks of HDMI Licensing Administrator, Inc.

THIS PRODUCT IS LICENSED UNDER THE MPEG-4 VISUAL PATENT PORTFOLIO LICENSE FOR THE PERSONAL AND NON-COMMERCIAL USE OF A CONSUMER FOR.

(i) ENCODING VIDEO IN COMPLIANCE WITH THE MPEG-4 VISUAL STANDARD ("MPEG-4 VIDEO") AND/OR  
(ii) DECODING MPEG-4 VIDEO THAT WAS ENCODED BY A CONSUMER ENGAGED IN A PERSONAL AND NON-COMMERCIAL ACTIVITY AND/OR WAS OBTAINED FROM A VIDEO PROVIDER LICENSED TO PROVIDE MPEG-4 VIDEO.

NO LICENSE IS GRANTED OR SHALL BE IMPLIED FOR ANY OTHER USE. ADDITIONAL INFORMATION INCLUDING THAT RELATING TO PROMOTIONAL, INTERNAL AND COMMERCIAL USES AND LICENSING MAY BE OBTAINED FROM MPEG LA, L.L.C. [HTTP://WWW.MPEGLA.COM](http://WWW.MPEGLA.COM)

THIS PRODUCT IS LICENSED UNDER THE AVC PATENT PORTFOLIO LICENSE FOR THE PERSONAL USE OF A CONSUMER OR OTHER USES IN WHICH IT DOES NOT RECEIVE REMUNERATION TO

- (i) ENCODE VIDEO IN COMPLIANCE WITH THE AVC STANDARD (“AVC VIDEO”) AND/OR
- (ii) DECODE AVC VIDEO THAT WAS ENCODED BY A CONSUMER ENGAGED IN A PERSONAL ACTIVITY AND/OR WAS OBTAINED FROM A VIDEO PROVIDER LICENSED TO PROVIDE AVC VIDEO.

NO LICENSE IS GRANTED OR SHALL BE IMPLIED FOR ANY OTHER USE. ADDITIONAL INFORMATION MAY BE OBTAINED FROM MPEG LA, L.L.C. SEE [HTTP://WWW.MPEGLA.COM](http://www.mpegla.com)

THIS PRODUCT IS LICENSED UNDER THE VC-1 PATENT PORTFOLIO LICENSE FOR THE PERSONAL AND NON-COMMERCIAL USE OF A CONSUMER FOR

- (i) ENCODING VIDEO IN COMPLIANCE WITH THE VC-1 STANDARD (“VC-1 VIDEO”) AND/OR
- (ii) DECODING VC-1 VIDEO THAT WAS ENCODED BY A CONSUMER ENGAGED IN A PERSONAL AND NON-COMMERCIAL ACTIVITY AND/OR WAS OBTAINED FROM A VIDEO PROVIDER LICENSED TO PROVIDE VC-1 VIDEO.

NO LICENSE IS GRANTED OR SHALL BE IMPLIED FOR ANY OTHER USE. ADDITIONAL INFORMATION INCLUDING THAT RELATING TO PROMOTIONAL, INTERNAL AND COMMERCIAL USES AND LICENSING MAY BE OBTAINED FROM MPEG LA, L.L.C. [HTTP://WWW.MPEGLA.COM](http://www.mpegla.com)

All other trademarks are trademarks of their respective owners.

In-Car Receiver  
XAV-AX8500

## Troubleshooting

---

Do the following before you request a repair service.

- Read the relevant instruction and troubleshooting topics in this Help Guide.
- Issues may be resolved by updating the software. When you install the “Support by Sony” app on your smartphone, you can get software update information conveniently.
- Visit our customer support home page.

If none of the above works, consult your nearest Sony dealer.

---

### Related Topic

- [Customer Support Websites](#)
- [About the “Support by Sony” App](#)

In-Car Receiver  
XAV-AX8500

## **There is no beep sound.**

---

- System sound is off in settings.

In-Car Receiver  
XAV-AX8500

## **The fuse has blown. / The unit makes noise when the position of the ignition is switched.**

- 
- The power supply leads are not matched correctly with the car's accessory power connector.

In-Car Receiver  
XAV-AX8500

## The display disappears from the monitor. / The display does not appear on the monitor.

---

- The monitor off function is activated.
    - Touch anywhere on the display to turn the display back on.
    - Press DISP OFF on the remote commander. (XAV-AX8500(E)/XAV-AX8500(E17)/XAV-AX8500(IN))
  - The standby function is activated.
    - Press HOME.
- 

### Related Topic

- [Main Unit and Remote Commander](#)
- [Screen Displays](#)



In-Car Receiver  
XAV-AX8500

## Menu items cannot be selected.

---

- Unavailable menu items are displayed in gray.

In-Car Receiver  
XAV-AX8500

## **The unit cannot be operated.**

---

- Press and hold HOME for more than 10 seconds to restart the unit.

In-Car Receiver  
XAV-AX8500

## The display does not turn on.

---

- The display may not be mounted properly.
  - Check that the installation and connection of the display are appropriately applied to the unit.

In-Car Receiver  
XAV-AX8500

## The touch screen does not react to your touch correctly.

---

- Touch one part of the touch screen at a time. If two or more parts are touched simultaneously, the touch screen will not react correctly.
- Touch the pressure sensitive screen firmly.
- The touch screen does not react when touching with a wet fingertip or when water droplets are on the touch screen.
  - Dry your wet fingertips well, or fully wipe water droplets off of the touch screen.

In-Car Receiver  
XAV-AX8500

## **Multi-touch is not recognized.**

---

- Multi-touch operation is not supported on this unit.

In-Car Receiver  
XAV-AX8500

**A suffix such as “-2”, “-3”, ... appears after the name of the device on [Device Connection].**

---

- The name of the connected device is duplicated. Change the name of the connected device.

In-Car Receiver  
XAV-AX8500

## **The radio reception is poor. / Static noise occurs.**

---

- Connect the antenna (aerial) firmly.
- Connection to REM OUT may be required.

5-050-133-11(1) Copyright 2023 Sony Corporation

In-Car Receiver  
XAV-AX8500

## The stations cannot be received. (XAV-AX8500(E)/XAV-AX8500(E17)/XAV-AX8500(IN))

---

- The tuning step setting has been erased.
    - Set the tuning step again.
- 

### Related Topic

- [Application](#)



In-Car Receiver  
XAV-AX8500

## **There is no picture or picture noise occurs.**

---

- Installation is not correct.
  - Install the unit at an angle of less than 30° in a sturdy part of the car.
- The parking lead (light green) is not connected to the parking brake switch lead, or the parking brake is not applied.
  - Check that the parking lead is firmly connected to the parking brake switch lead, then apply the parking brake.

In-Car Receiver  
XAV-AX8500

## There is no sound, sound skips, or sound cracks.

---

- The connection between this unit and the connected equipment has not been established correctly.
    - Check the connection between this unit and the connected equipment and set the input selector of the equipment to the source corresponding to this unit. If the problem continues, disconnect the equipment and reconnect it to this unit.
  - Installation is not correct.
    - Install the unit at an angle of less than 30° in a sturdy part of the car.
  - The unit is in pause/reverse/fast-forward mode.
  - The settings for the outputs are not made correctly.
  - The volume is too low or too high.
  - The mute function is activated.
  - The format is not supported.
    - Check if the format is supported by this unit.
  - There may be radio interference in the vicinity.
    - Move to a place with a good signal environment and connect again.
- 

### Related Topic

- [Supported Formats for USB Playback](#)

In-Car Receiver  
XAV-AX8500

## Sound is noisy.

---

- Keep cords and cables away from each other.

In-Car Receiver  
XAV-AX8500

## Items cannot be played.

---

- Reconnect the USB device.
- Make sure the USB device or file is supported.
- USB devices formatted with file systems other than FAT16, FAT32 or exFAT are unsupported.\*

\* This unit supports FAT16, FAT32 and exFAT, but some USB device may not support all of these. For details, refer to the operating instructions of each USB device or contact the manufacturer.

In-Car Receiver  
XAV-AX8500

## **The USB device takes longer to play.**

---

- The USB device contains large-sized files, large amount of files, or files with a complicated tree structure.

In-Car Receiver  
XAV-AX8500

## The smartphone connected to the USB port cannot be played.

---

- The USB connection is only available for Android phones and USB devices in MSC mode.  
When using a smartphone other than an Android phone, make a BLUETOOTH connection.
- 

### Related Topic

- [Pairing and Connecting with a Bluetooth® Device](#)
- [Connecting with a Paired BLUETOOTH Device](#)

In-Car Receiver  
XAV-AX8500

## The connected HDMI device cannot be played.

---

- Check the supported file formats for the connected HDMI device.
  - HDMI devices formatted with file systems other than 480p, 576p, or 720p are unsupported.
- If [Video signal not detected] appears on the display, set the resolution of the HDMI device to match the resolution of the unit.
- Check that the HDMI cable is firmly inserted to the unit. It is also recommended to use a certified HDMI cable.
- Disconnect the BLUETOOTH connection, Apple CarPlay, and Android Auto from your iPhone or Android phone that uses an HDMI connection.

## HDMI playback stops.

---

- When playing back video from an HDMI device, playback may stop when the interrupt function is activated from the Rear Camera, Camera 1, or Camera 2 depending on the connected HDMI device.
- When the interrupt function is set to [Off], video can be played without being stopped.
  - Select [Settings] → [Application] → [Camera Display] → [Rear Camera Interruption], [Camera 1 Interruption], or [Camera 2 Interruption].  
(The camera video is displayed by touching [RearCam], [Camera 1], or [Camera 2] on the HOME screen.)
- When the iDataLink Maestro module (not supplied) is connected, configure the interrupt function in [Maestro Settings].
  - Select [Settings] → [Application] → [Maestro Settings].



In-Car Receiver  
XAV-AX8500

## The other BLUETOOTH device cannot detect this unit.

---

- Set [Bluetooth Signal] to [On].
  - Depending on your smartphone or mobile phone, you may need to delete this unit from the history of the connected smartphone or mobile phone, then pair them again.
- 

### Related Topic

- [Pairing and Connecting with a Bluetooth® Device](#)
- [Connecting with a Paired BLUETOOTH Device](#)
- [Device Connection](#)

In-Car Receiver  
XAV-AX8500

## Connection is not possible.

---

- Check the pairing and connection procedures in the manual of the other device, etc., and perform the operation again.

5-050-133-11(1) Copyright 2023 Sony Corporation

In-Car Receiver  
XAV-AX8500

## The name of the detected device does not appear.

---

- Depending on the status of the other device, it may not be possible to obtain the name.

In-Car Receiver  
XAV-AX8500

## There is no ringtone.

---

- Raise the volume while receiving a call.
- To adjust the ringtone volume, press HOME, touch [Settings], and select [Ring Tone] of [Volume Settings] in [System].
- The speakers are not connected to the unit.
  - Connect the speakers to the unit. To select the speakers for ringtone, press HOME, then touch [Settings] and select [Optional Audio Output Channel] in [System].

In-Car Receiver  
XAV-AX8500

## The talker's voice volume is low.

---

- Raise the volume during a call.
- To adjust the talker's voice volume, press HOME, touch [Settings], and select [Phone Call] of [Volume Settings] in [System].

5-050-133-11(1) Copyright 2023 Sony Corporation

In-Car Receiver  
XAV-AX8500

## The other party says that the volume is too low or high.

---

- Adjust the [MIC Gain] level.
- 

### Related Topic

- [Available Operations during a Call](#)

5-050-133-11(1) Copyright 2023 Sony Corporation

In-Car Receiver  
XAV-AX8500

## Echo or noise occurs during call conversations.

---

- Reduce the volume.
  - If ambient noise other than the phone call sound is loud, try reducing this noise.
    - Shut the window if road noise is loud.
    - Lower the air conditioner if the air conditioner is loud.
- 
- 

### Related Topic

- [Available Operations during a Call](#)

In-Car Receiver  
XAV-AX8500

## The phone sound quality is poor.

---

- Phone sound quality depends on reception conditions of the mobile phone.
  - Move your car to a place where you can enhance the mobile phone's signal if the reception is poor.

5-050-133-11(1) Copyright 2023 Sony Corporation



In-Car Receiver  
XAV-AX8500

## The volume of the connected BLUETOOTH device or apps is low or high.

---

- Volume level will differ depending on the BLUETOOTH device or apps.
    - Reduce the volume level differences between this unit and the BLUETOOTH device or apps.
- 

### Related Topic

- [Playing a BLUETOOTH Device](#)

In-Car Receiver  
XAV-AX8500

## The sound skips during audio streaming or the BLUETOOTH connection fails.

---

- Reduce the distance between the unit and the BLUETOOTH device.
- If the BLUETOOTH device is stored in a case which interrupts the signal, remove the case while using the device.
- Several BLUETOOTH devices or other devices (e.g. ham radio devices) which emit radio waves are used nearby.
  - Turn off the other devices.
  - Increase the distance between the unit and other devices.
- Playback sound stops momentarily when this unit is connecting to a mobile phone. This is not a malfunction.

In-Car Receiver  
XAV-AX8500

**The connected BLUETOOTH device cannot be controlled during audio streaming.**

---

- Check that the connected BLUETOOTH device supports AVRCP.

In-Car Receiver  
XAV-AX8500

## Some functions do not work.

---

- Check that the connecting device supports the functions in question.
  - Visit the support site, then check the compatibility list.
- 
- 

### Related Topic

- [Customer Support Websites](#)

In-Car Receiver  
XAV-AX8500

## A call is answered unintentionally.

---

- The connecting phone is set to start a call automatically.
  - [Auto Answer] of this unit is set to [On].
- 

### Related Topic

- [Available Operations during a Call](#)

In-Car Receiver  
XAV-AX8500

## Pairing failed due to time out.

---

- Depending on the connecting device, the time limit for pairing may be short. Try completing the pairing within the time.

In-Car Receiver  
XAV-AX8500

## Cannot pair.

---

- The unit may not be able to pair with a previously paired BLUETOOTH device after initializing the unit if the pairing information of the unit is on the BLUETOOTH device. In this case, delete the pairing information of the unit from the BLUETOOTH device, and then pair them again.

In-Car Receiver  
XAV-AX8500

## The BLUETOOTH function cannot be operated.

---

- Turn the ignition off. Wait for a while, then turn the ignition to the ACC position.



In-Car Receiver  
XAV-AX8500

## **No sound is output from the car speakers during a handsfree call.**

---

- If the sound is output from the mobile phone, set the mobile phone to output the sound from the car speakers.
- Check the volume level of the car speakers.

In-Car Receiver  
XAV-AX8500

## **A mature channel is not blocked although parental control setting has been made.**

---

- If you tune to a mature channel, the passcode display will appear. Once you have entered the passcode, you will have unblocked parental control for all channels until the unit is powered down or you turn parental control back on. Set [Parental Control] to [Locked] in the SXM option ( ●●● ) again.
- 

### **Related Topic**

- [Using SXM Option Functions](#)

In-Car Receiver  
XAV-AX8500

## The Apple CarPlay icon does not appear on the HOME screen.

---

- Your iPhone is not compatible with Apple CarPlay.
  - Refer to the manual supplied with your iPhone, or visit the Apple CarPlay website.
  
- Disconnect your iPhone and reconnect it again.
- Check that the Wi-Fi setting of your iPhone is [ON].
- Check that the GPS antenna (aerial) (supplied) is connected.
- Check that your iPhone is connected with [Device Connection] of [Settings].
- Apple CarPlay may not be available in your country or region.
- Check the setting of Apple CarPlay on your iPhone.
- Remove the HDMI cable from your iPhone.

In-Car Receiver  
XAV-AX8500

## The position accuracy is not good when using maps with Apple CarPlay.

---

- Check the location where the GPS antenna (aerial) (supplied) is installed. Some types of front windshields (windscreens) block GPS satellite radio waves. In that case, install the GPS antenna (aerial) (supplied) near the window.
- Do not paint the GPS antenna (aerial) (supplied). It may affect the accuracy.
- The correction status of the internal sensor may be insufficient.
  - Moving your car to a location where no obstacle blocks GPS satellite reception as well as turning left and right several times may improve the performance of the internal sensor.

## The Android Auto icon does not appear on the HOME screen.

---

- Check your Android phone and complete the initial set up process on your Android phone.
- There is no Android Auto application installed on your Android phone.
  - Download and install the Android Auto application or update to the latest version of the application onto your Android phone.
  - The Android Auto app is integrated into phones with Android 10 and above. You do not need to download it. If you need to access the app, you can find it in your phone (Settings/Apps). Android Auto isn't available on devices that run Android (Go edition).
- Your Android phone is not compatible with Android Auto.
  - Your Android phone needs to support Android Auto. Refer to the manual supplied with your Android phone, or visit the Android Auto website.
- Disconnect your Android phone and reconnect it again.
- Check that your Android phone is connected with [Device Connection] of [Settings].
- Android Auto may not be available in your country or region.
- Remove the HDMI cable from your Android phone.

In-Car Receiver  
XAV-AX8500

## The position accuracy is not good when using maps with Android Auto.

---

- Check the location where the GPS antenna (aerial) (supplied) is installed. Some types of front windshields (windscreens) block GPS satellite radio waves. In that case, install the GPS antenna (aerial) (supplied) near the window.
- Do not paint the GPS antenna (aerial) (supplied). It may affect the accuracy.
- The correction status of the internal sensor may be insufficient.
  - Moving your car to a location where no obstacle blocks GPS satellite reception as well as turning left and right several times may improve the performance of the internal sensor.

In-Car Receiver  
XAV-AX8500

## iDataLink Maestro

---

If you have any inquiries about the functions, settings and connections of iDataLink Maestro, visit the website:

<https://www.idatalinkmaestro.com/>

or contact:

Automotive Data Solutions Inc.

Email: [maestrosupport@adsdata.ca](mailto:maestrosupport@adsdata.ca)

Call: 1-866-427-2999

## General

---

### Cannot play selected content

- The currently selected content cannot be played back, or skipped to the next one.
  - The content is not in a supported file format. Check supported file formats.

### The device is not responding

- The unit does not recognize the connected USB device.
  - Reconnect the USB device.
  - Check that the USB device is supported by the unit.

### No playable content

- The USB device has no playable data.
  - Load the supported data/files into the USB device.

### Overcurrent caution on USB

- The USB device is overloaded.
  - Disconnect the USB device.
  - The USB device has a fault, or an unsupported device is connected.

### Connected USB device not supported

- For details on the compatibility of your USB device, visit the support site.

### USB hub not supported

- USB hubs are not supported on this unit.

---

### Related Topic

- [Supported Formats for USB Playback](#)
- [Customer Support Websites](#)



In-Car Receiver  
XAV-AX8500

## SiriusXM Connect Vehicle Tuner (XAV-AX8500(UC))

---

### Channel Locked. Please Enter the Lock Code.

- The channel that you have requested is Locked by the radio Parental Control feature. See “[Setting a Parental Control](#)” for more information on the Parental Control feature and how to access locked channels.

### Channel Not Available

- The channel that you have requested is not a valid SiriusXM channel or the channel that you were listening to is no longer available.
- You may also see this message briefly when first connecting a new SiriusXM Connect Vehicle Tuner. Visit [www.siriusxm.com](http://www.siriusxm.com) in the USA or [www.siriusxm.ca](http://www.siriusxm.ca) in Canada for SiriusXM channel lineup information.

### Channel Not Subscribed. Call SiriusXM to Subscribe.

- The channel that you have requested is not included in your SiriusXM subscription package or the channel that you were listening to is no longer included in your SiriusXM subscription package. If you have questions about your subscription package or would like to subscribe to this channel, please contact SiriusXM. In the USA, you can activate online or by calling SiriusXM Listener Care:
  - Visit [www.siriusxm.com/activatenow](http://www.siriusxm.com/activatenow)
  - Call SiriusXM Listener Care at 1-866-635-2349

For Canadian Subscriptions, please contact:

- Visit [www.siriusxm.ca/activate](http://www.siriusxm.ca/activate)
- Call SiriusXM Customer Care at 1-888-539-7474

### Check Antenna

- The radio has detected a fault with the SiriusXM antenna (aerial).
- The antenna (aerial) cable may be either disconnected or damaged.
  - Verify that the antenna (aerial) cable is connected to the SiriusXM Connect Vehicle Tuner.
  - Inspect the antenna (aerial) cable for damage and kinks.
  - Replace the antenna (aerial) if the cable is damaged. SiriusXM products are available at your local car audio retailer or online at <https://shop.siriusxm.com/all-parts/>

### Check SXM Tuner

- The radio is having difficulty communicating with the SiriusXM Connect Vehicle Tuner.
- The tuner may be disconnected or damaged.
  - Verify that the SiriusXM Connect Vehicle Tuner cable is securely connected to the radio.

### Incorrect Pass Code entered

- Passcode input failed.
  - Check that the passcode has been entered correctly.
  - If you forget your passcode, perform [SXM Reset] in [Application]. Note that performing [SXM Reset] will initialize all the SiriusXM settings and stored contents in the SiriusXM Connect Vehicle Tuner.

### No signal

- SiriusXM Connect Vehicle Tuner is having difficulty receiving the SiriusXM satellite signal.

- Verify that your vehicle is outdoors with a clear view of the sky.
- Verify that the SiriusXM magnetic mount antenna (aerial) is mounted on a metal surface on the outside of the vehicle.
- Move the SiriusXM antenna (aerial) away from any obstructions.
- Inspect the antenna (aerial) cable for damage and kinks.
- Consult the SiriusXM Connect Vehicle Tuner installation manual for more information on antenna (aerial) installation.
- Replace the antenna (aerial) if the cable is damaged. SiriusXM products are available at your local car audio retailer or online at <https://shop.siriusxm.com/all-parts/>

**Subscription Updated. Press Enter to Continue.**

- The radio has detected a change in your SiriusXM subscription status.
  - Press Enter to clear the message.  
If you have questions about your subscription, please contact SiriusXM.  
In the USA, you can activate online or by calling SiriusXM Listener Care:  
Visit [www.siriusxm.com/activatenow](http://www.siriusxm.com/activatenow)  
Call SiriusXM Listener Care at 1-866-635-2349  
For Canadian Subscriptions, please contact:  
Visit [www.siriusxm.ca/activate](http://www.siriusxm.ca/activate)  
Call SiriusXM Customer Care at 1-888-539-7474

---

---

**Related Topic**

- [Setting a Parental Control](#)
- [Application](#)

5-050-133-11(1) Copyright 2023 Sony Corporation

In-Car Receiver  
XAV-AX8500

## Customer Support Websites

---

You can access the following customer support websites to get support information about your system.

For customers in the USA/Canada/Latin America:

<https://www.sony.com/am/support>

For customers in European countries:

<https://www.sony.eu/support>

For customers in other countries/regions:

<https://www.sony-asia.com/support>

### For customers in the USA

If you have any questions/problems regarding this product, try the following:

1. Read Troubleshooting in this Help Guide.
2. Please contact (U.S.A. only);  
Call 1-800-222-7669  
URL <https://www.SONY.com>

### For customers in European countries

Register your product online now at:

<https://www.sony.eu/mysony>

In-Car Receiver  
XAV-AX8500

## About the “Support by Sony” App

---

When you install the “Support by Sony” app on your smartphone, you can get software update information conveniently.

**“Support by Sony” app - Find information and get notifications about your product:**



- ✓ News & Alerts
- ✓ Software updates
- ✓ Tutorials
- ✓ Tips & Tricks

<https://sony.net/SBS>

Visit the “Support by Sony” website at [sony.net/SBS](https://sony.net/SBS), and bookmark the model name of the unit, “XAV-AX8500”, when you visit the website.

## XAV-AX8500

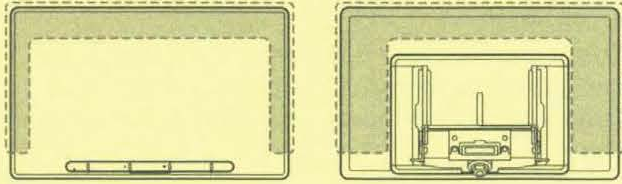

### English

#### Precautions when adjusting the display angle

- Grip the top, left, or right side of the display as indicated by the shaded areas.
- Be careful not to get your fingers caught.
- Do not apply an excessive load of 10 kg (22 lb 1 oz) or more.

### Français

#### Précautions à prendre lors du réglage de l'angle de l'écran

- Saisissez le haut, le côté gauche ou le côté droit de l'écran comme indiqué par les zones ombrées.
- Veillez à ne pas vous coincer les doigts.
- N'appliquez pas de charge excessive de 10 kg (22 lb 1 oz) ou plus.

### Español

#### Precauciones cuando se ajusta el ángulo de la pantalla

- Sujete la parte superior izquierda o derecha de la pantalla, como indican las zonas sombreadas.
- Tenga cuidado de no apretarse los dedos.
- No aplique una carga excesiva de 10 kg o más.

### Bahasa Indonesia

#### Tindakan pencegahan saat menyesuaikan sudut layar

- Pegang sisi atas, kiri, atau kanan layar sebagaimana ditunjukkan oleh area berarsir.
- Berhati-hatilah agar jari-jari Anda tidak terjepit.
- Jangan berikan beban berlebih sebesar 10 kg atau lebih.

### 繁體中文

#### 調整螢幕角度時的注意事項

- 請握住顯示器頂部、左側或右側，如陰影區域所示。
- 請小心不要夾住手指。
- 請勿過度負載10 kg或以上。

### اللغة العربية

#### تنبيهات احتياطية عند ضبط زاوية الشاشة

- امسك الجانب العلوي أو الأيسر أو الأيمن من الشاشة كما تشير إليه المناطق المظلمة.
- احرص على عدم احتباس أصابعك.
- لا تضع حمولة زائدة مقدارها 10 كجم أو أكثر.





## XAV-AX8500

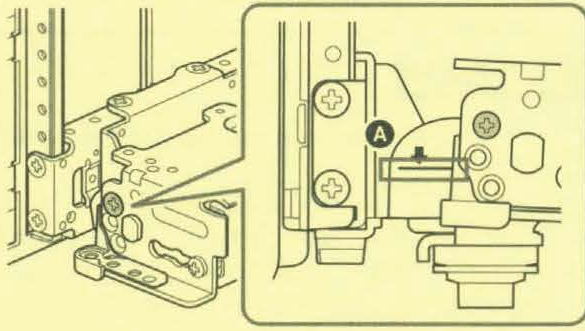

### English

#### About the pre-installation for display angle adjustment

- Adjust the mounting position of the screw located where the line (A) on the swivel cover is closest to the ground and oriented horizontally.
- The installation angle on the vehicle is determined based on the vehicle, and the position of the pre-installed screw is determined accordingly.

### Français

#### À propos de la préinstallation pour le réglage de l'angle de l'écran

- Réglez la position de montage de la vis située à l'endroit où la ligne (A) du couvercle pivotant est la plus proche du sol et orientée horizontalement.
- L'angle d'installation sur le véhicule est déterminé en fonction du véhicule et la position de la vis préinstallée est déterminée en conséquence.

### Español

#### Acerca de la instalación previa para el ajuste del ángulo de la pantalla

- Ajuste la posición de montaje del tornillo que se ubica donde la línea (A) de la cubierta giratoria esté más cerca del suelo y con orientación horizontal.
- El ángulo de instalación en el vehículo se determina según el mismo y la posición del tornillo previamente instalado se determina en consecuencia.

### Bahasa Indonesia

#### Tentang pra-pemasangan untuk penyesuaian sudut layar

- Sesuaikan posisi pemasangan sekrup yang terletak di mana garis (A) pada penutup putar paling dekat dengan tanah dan diposisikan secara horizontal.
- Sudut pemasangan pada kendaraan ditentukan sesuai kendaraannya. Lalu, posisi sekrup yang sudah terpasang sebelumnya ditentukan dengan tepat.

### 繁體中文

#### 關於螢幕預安裝角度調整

- 調整螺絲的安裝位置，使旋轉罩上的標線 (A) 處於最接近地面且水平的位置。
- 安裝角度因車輛而定，並由此決定預安裝的螺絲位置。

### اللغة العربية

#### حول التركيب المسبق لضبط زاوية الشاشة

- اضبط موضع تثبيت البرغي الموجود حيث يكون الخط (A) على الغطاء الدوار الأقرب إلى الأرض ومتجهًا أفقيًا.
- يتم تحديد زاوية التركيب على السيارة استنادًا إلى السيارة، ويتم تحديد موقع البرغي المثبت مسبقًا وفقًا لذلك.

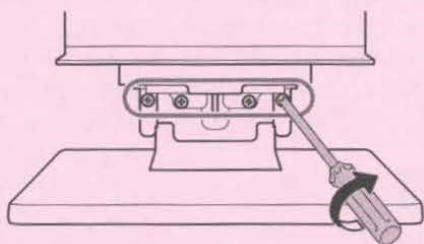

## English

- Tighten the screws firmly.
- When using the unit for a long period of time, there may be a possibility that the screws securing the display may come loose. Periodically tighten these screws.
- Do not pinch your fingers when attaching the display to the unit.

## Français

- Serrez les vis fermement.
- Après une longue période d'utilisation, les vis qui maintiennent l'écran peuvent se desserrer. Serrez périodiquement ces vis.
- Ne vous pincez pas les doigts lorsque vous fixez l'écran à l'appareil.

## Deutsch

- Ziehen Sie die Schrauben fest an.
- Wenn Sie das Gerät längere Zeit verwenden, besteht die Möglichkeit, dass sich die Schrauben, mit denen das Display befestigt ist, lösen. Ziehen Sie diese Schrauben regelmäßig an.
- Klemmen Sie sich nicht die Finger, wenn Sie das Display am Gerät anbringen.

## Español

- Apriete los tornillos con firmeza.
- Al utilizar la unidad durante un periodo de tiempo prolongado, existe la posibilidad de que se aflojen los tornillos que mantienen la pantalla en posición. Apriete estos tornillos de forma periódica.
- Tenga cuidado para evitar pellizcarse los dedos al conectar la pantalla a la unidad.

For France only / Seulement pour la France



## Nederlands

- Draai de schroeven stevig vast.
- Na langdurig gebruik van het toestel is het mogelijk dat de schroeven die het scherm op zijn plaats houden, loskomen. Span deze schroeven regelmatig aan.
- Wees voorzichtig dat uw vingers niet geklemd raken bij het bevestigen van het scherm aan het toestel.

## Svenska

- Dra åt skruvarna ordentligt.
- Om enheten används under längre tidsperioder kan det hända att skruvarna som fäster displayen kan lossna. Dra regelbundet åt dessa skruvar.
- Var försiktig så att du inte klämmer fingrarna när du fäster displayen på enheten.

## Italiano

- Serrare saldamente le viti.
- Quando si utilizza l'apparecchio per un periodo di tempo prolungato, è possibile che le viti che fissano il display si allentino. Serrare regolarmente queste viti.
- Prestare attenzione affinché le dita non vengano pizzicate durante il fissaggio del display all'apparecchio.

## Português

- Aperte firmemente os parafusos.
- Ao utilizar a unidade durante períodos de tempo prolongados, os parafusos que fixam o ecrã podem soltar-se. Aperte periodicamente estes parafusos.
- Não entale os dedos ao colocar o ecrã na unidade.

## Dansk

- Spænd skruerne ordentligt.
- Når enheden bruges i en længere periode, er det muligt, at skruerne, som sikrer displayet, kan løsne sig. Spænd regelmæssigt disse skruer.
- Pas på ikke at klemme fingrene, når displayet skal fastgøres til enheden.





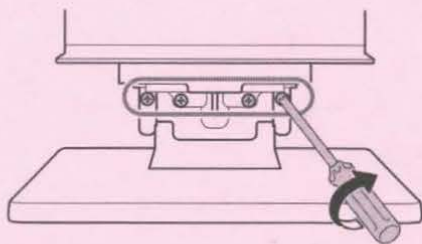

### Suomi

- Kiristä ruuvit.
- Kun laitetta käytetään pitkäjäksoisesti, on olemassa mahdollisuus, että näytön kiinnitysruuvit voivat löystyä. Kiristä nämä ruuvit säännöllisesti.
- Älä jätä sormiasi puristuksiin, kun kiinnität näytön laitteeseen.

### Norsk

- Stram skruene godt til.
- Når enheten brukes over lengre tid er det mulig at skruene som holder displayet på plass blir løse. Stram til skruene av og til.
- Ikke klem fingrene når du fester displayet på enheten.

### Polski

- Mocno dokręć śruby.
- Po dłuższej eksploatacji urządzenia śruby mocujące wyświetlacz mogą się poluzować. Należy okresowo dokręcać te śruby.
- Należy uważać, aby nie przyszczyznać palców podczas mocowania wyświetlacza do urządzenia.

### Ελληνικά

- Σφίξτε καλά τις βίδες.
- Κατά τη χρήση της μονάδας για μεγάλο χρονικό διάστημα, οι βίδες που ασφαλίζουν την οθόνη ενδέχεται να χαλαρώσουν. Να σφίγγετε κατά διαστήματα αυτές τις βίδες.
- Προσέξτε να μην μαγκώσετε τα δάχτυλά σας κατά την προσάρτηση της οθόνης στη μονάδα.

### Česky

- Dotáhněte šrouby pevně.
- Když budete jednotku používat delší dobu, může dojít k tomu, že se šrouby upevňující displej uvolní. Proto tyto šrouby pravidelně dotahujte.
- Při upevňování displeje jednotky si neskřípněte prsty.

### Magyar

- Erősen húzza meg a csavarokat.
- Az egység hosszas használata során lehetséges, hogy a kijelzőt tartó csavarok kilazulhatnak. Rendszeresen húzza meg ezeket a csavarokat.
- A kijelző és az egység csatlakoztatásakor ne csípje be az ujját.

### Български

- Здраво затегнете винтовете.
- При използване на устройството за дълъг период от време има вероятност поддържащите дисплея винтове да се разхлабят. Периодично затягайте винтовете.
- Внимавайте да не си прищипете пръстите, когато монтирате дисплея към устройството.

### Slovensky

- Skrutky pevne dotiahnite.
- Po dlhšom čase používania je možné, že sa skrutky držiace displej uvoľnia. Skrutky pravidelne dotahujte.
- Pri nasadzovaní displeja na zariadenie dávajte pozor, aby ste si nepričikli prsty.

### Română

- Strângeți bine șuruburile.
- Când utilizați unitatea pentru o perioadă îndelungată de timp, este posibil ca șuruburile care fixează afișajul să se slăbească. Strângeți periodic aceste șuruburi.
- Aveți grijă să nu vă prindeți degetele atunci când atașați afișajul la unitate.

### 繁體中文

- 穩固旋緊螺絲。
- 長時間使用本機時，用於固定顯示幕的螺絲可能會鬆脫。請定期旋緊這些螺絲。
- 將顯示幕連接本機時，請勿夾傷手指。

### اللغة العربية

- ثبتت المسامير بإحكام.
- عند استخدام الوحدة لفترة طويلة من الزمن، قد يكون هناك احتمال أن تصبح المسامير التي تثبت الشاشة طليقة. اربط هذه المسامير بإحكام بشكل دوري.
- لا تضغط بأصابعك عند توصيل الشاشة بالوحدة.

### فارسی

- پیچ ها را محکم ببندید.
- هنگام استفاده از دستگاه برای مدت زمان طولانی، احتمال شل شدن پیچ هایی که صفحه نمایش را بسته اند وجود دارد. در فواصل معینی، پیچ ها را محکم کنید.
- هنگام وصل کردن صفحه نمایش به دستگاه، مراقب باشید انگشتانتان در دستگاه گیر نکنند.





4-597-061-12

**SONY**<sup>®</sup>**LIMITED WARRANTY**

Car Audio

**U.S. and Canada only – 3 years**

Sony Electronics Inc. solely for purchases made in the United States and Sony of Canada Ltd. solely for purchases made in Canada (collectively "Sony") warrants this product against defects in material or workmanship for the original owner and any subsequent end user owner(s) ("You" or "Your") for the time period set forth above as set forth herein. Pursuant to this Limited Warranty, Sony will, at its option, (i) repair the product using new or refurbished parts or (ii) replace the product with a new or recertified/refurbished product of the same (or similar) model. For purposes of this Limited Warranty, "recertified" or "refurbished" means a product or part that has been returned to its original specifications. **In the event of a defect, these are Your exclusive remedies.** Sony does not warrant that the operation of the product will be uninterrupted or error-free.

**Term:** For the time period set forth above from the original date of purchase of the product when purchased directly from Sony or Sony authorized dealer (To determine if a dealer is in the Sony authorized dealer network, please visit US: [www.sony.com/retailers](http://www.sony.com/retailers); Canada: <https://dealerlocator.sony.ca/locator>; or contact Sony directly), Sony will, at its option, repair or replace with a new, recertified or refurbished product or part, any product or part determined to be defective.

**This Limited Warranty covers** only the hardware components packaged with the product. It does not cover separate accessories, technical assistance for hardware or software usage and it does not cover any software products whether or not contained in the product, and other included content; any such software or other included content is provided "AS IS" unless expressly provided for in any enclosed software Limited Warranty or End User License Agreement. Please refer to the End User License Agreement(s) included with the product for Your rights and obligations with respect to the software or other included content. If You purchased an extended service plan, please refer to the service plan for the coverage, duration and terms of service. Extended service plans are not governed by this Limited Warranty.

**To obtain warranty service,** You must deliver the product, in either its original packaging or packaging affording an equal degree of protection to a Sony authorized service center together with a dated purchase receipt in order to obtain warranty service. Sony cannot guarantee that it will be able to repair any product under this warranty or make a product exchange without risk to or loss of software or data. **It is Your responsibility to remove or backup any removable media or parts, data, software or other materials You may have stored or preserved on Your product. It is likely that any media or parts, data, software, or other materials (like pictures, music, videos, etc.) will be lost or reformatted during service and Sony will not be responsible for any such damage or loss.** Contact the following for specific instructions on how to obtain warranty service for Your product:

**For purchases made in the UNITED STATES:**Visit Sony's Website: [www.sony.com/support](http://www.sony.com/support)

Or call the Customer Experience Center: 1-800-222-SONY (7669)

To register Your product or for contact information to purchase accessories or parts go to Sony's Website

**For purchases made in CANADA:**Visit Sony's Website: [www.sony.ca/support](http://www.sony.ca/support)

Or call the Customer Experience Center: 1-877-899-SONY (7669)

To register Your product or for contact information to purchase accessories or parts go to Sony's Website

On-site service for televisions of certain dimensions may be available to a customer living within a 50km radius of an authorized Sony service facility, provided the residence can be accessed by an on-road service vehicle.

**Repair/Replacement Warranty:** This Limited Warranty shall apply to any repair, replacement part or replacement, recertified or refurbished product for the remainder of the original Limited Warranty period or for ninety (90) days, whichever is longer. Any parts or product replaced under this Limited Warranty will become the property of Sony. Any replacement, recertified or refurbished product provided under this Limited Warranty may, at Sony's option, vary in color and/or cosmetic design from the original product and may not include any original engraving or similar customization/personalization.

Sony is not responsible for, and this Limited Warranty does not cover, any damage arising from a failure to operate the product within its intended uses, or otherwise follow the owner's manual and safety instructions relating to the product's use and installation. Sony is not responsible for any labor or parts costs you incur relating to repairs or services from providers/servicers other than from a Sony authorized service center. This Limited Warranty only covers product issues caused by defects in material or workmanship during ordinary consumer use. This Limited Warranty does not cover products purchased from sources other than Sony or a Sony authorized dealer (including non-authorized online auctions), or issues due to: (i) outdoor exposure and other acts of nature; (ii) power surges; (iii) accidental damage; (iv) abuse; (v) limitations of technology; (vi) cosmetic damage; (vii) contact with liquid, heat, humidity or perspiration, sand, smoke, or foreign materials; (viii) damage, malfunction and/or failure to product resulting from use of parts or supplies not sold or authorized by Sony; (ix) damage, malfunction and/or failure to product resulting from servicing not authorized or performed by Sony or a Sony authorized service center; (x) computer or internet viruses, bugs, worms, or Trojan Horses; (xi) malfunctions due to peripherals/accessories; (xii) modifications of or to any part of the product, including "rooting" or other modifications to control the behavior of the product or any factory installed operating system; (xiii) consumable parts such as batteries; or (xiv) any product where the factory-applied serial number has been altered or removed from the product. Further, to the extent this product incorporates use of a display, please note that a display contains hundreds of thousands of individual pixels, and displays typically contain a small number of pixels that do not function properly. This Limited Warranty does not cover up to .01% pixel outages (small dot picture elements that are dark or incorrectly illuminated).

This Limited Warranty does not cover Sony products sold "AS IS" or "WITH ALL FAULTS" or consumables (such as fuses or disposable batteries). Sony will not replace missing components from any package purchased "Open Box" or "AS IS". This Limited Warranty is valid only in the United States and Canada (as applicable).

**LIMITATION ON DAMAGES:** SONY SHALL NOT BE LIABLE FOR ANY INCIDENTAL OR CONSEQUENTIAL DAMAGES FOR BREACH OF ANY EXPRESS OR IMPLIED WARRANTY OR CONDITION ON THIS PRODUCT. NOR SHALL RECOVERY OF ANY KIND AGAINST SONY BE GREATER THAN THE ORIGINAL PURCHASE PRICE OF THE PRODUCT FROM SONY OR AN AUTHORIZED SONY DEALER.

**DURATION OF IMPLIED WARRANTIES OR CONDITIONS:** EXCEPT TO THE EXTENT PROHIBITED BY APPLICABLE LAW, ANY IMPLIED WARRANTY OF MERCHANTABILITY OR FITNESS FOR A PARTICULAR PURPOSE ON THIS PRODUCT IS LIMITED IN DURATION TO THE DURATION OF THIS LIMITED WARRANTY.

Some jurisdictions do not allow the exclusion or limitation of incidental or consequential damages, or allow limitations on how long an implied warranty lasts, so the above limitations or exclusions may not apply to You. This Limited Warranty gives You specific legal rights and You may have other rights which vary from jurisdiction to jurisdiction.

**For purchases made in the U.S.:** Read the following **Dispute Resolution/Arbitration** provision carefully. It details Your rights and instructions should a dispute related to the product arise.

**What Happens If We Have A Dispute:** Should a dispute or claim arise related to the product, Your purchase and/or use of the product, the terms of this Limited Warranty, or any service provided under the terms of this Limited Warranty (including any repair or replacement) ("Dispute"), You and Sony agree that the **Dispute shall be resolved exclusively through binding arbitration. YOU UNDERSTAND AND ACKNOWLEDGE THAT BY AGREEING TO ARBITRATION, YOU ARE GIVING UP THE RIGHT TO LITIGATE (OR PARTICIPATE IN AS A PARTY OR CLASS MEMBER) IN ANY DISPUTES IN COURT.** You also agree that **ANY DISPUTE RESOLUTION PROCEEDING WILL ONLY CONSIDER YOUR INDIVIDUAL CLAIMS, AND BOTH PARTIES AGREE NOT TO HAVE ANY DISPUTE HEARD AS A CLASS ACTION, REPRESENTATIVE ACTION, CONSOLIDATED ACTION, OR PRIVATE ATTORNEY GENERAL ACTION.** Despite the above, You have the right to litigate any Dispute on an individual basis in small claims court or other similar court of limited jurisdiction, to the extent the amount at issue does not exceed \$15,000, and as long as such court has proper jurisdiction and all other requirements (including the amount in controversy) are satisfied.

**Arbitration Instructions.** To begin Arbitration, either You or Sony must make a written demand to the other for arbitration. The Arbitration will take place before a single arbitrator. The arbitration will be administered in keeping with the Expedited Procedures of the Commercial Arbitration Rules and the Supplementary Proceedings for Consumer-Related disputes ("Rules") of the American Arbitration Association ("AAA"), when applicable and in effect when the claim is filed. You may get a copy of AAA's Rules by contacting AAA at (800) 778-7879 or visiting [www.adr.org](http://www.adr.org). The filing fees to begin and carry out arbitration will be shared between You and Sony, but in no event shall Your fees ever exceed the amount allowable by the special rules for Consumers Disputes provided for by AAA, at which point Sony will cover all additional administrative fees and expenses. This does not prohibit the Arbitrator from giving the winning party their fees and expenses of the arbitration when appropriate pursuant to the Rules. Unless You and Sony agree differently, the arbitration will take place in the county and state where You live, and applicable federal or state law shall govern the substance of any Dispute during the arbitration. However, the Federal Arbitration Act, 9 U.S.C. § 1, et seq., will govern the arbitration itself and not any state law on arbitration. The Arbitrator's decision will be binding and final, except for a limited right of appeal under the Federal Arbitration Act.

**Opt-Out Instructions. IF YOU DO NOT WISH TO BE BOUND BY THE BINDING ARBITRATION PROVISION, THEN:** (1) You must notify Sony in writing within 30 days of the date that You purchased the product; (2) Your written notification must be mailed to Sony Electronics Inc., 16535 Via Esprillo, MZ 1105, San Diego CA 92127, Attn: Legal Department; AND (3) Your written notification must include (a) Your NAME, (b) Your ADDRESS, (c) the DATE You purchased the product, and (d) a clear statement that "YOU DO NOT WISH TO RESOLVE DISPUTES WITH ANY SONY ELECTRONICS ENTITY THROUGH ARBITRATION AND/OR BE BOUND BY THE CLASS ACTION WAIVER."

Opting out of this dispute resolution procedure will not affect the coverage of the Limited Warranty in any way, and You will continue to enjoy the benefits of the Limited Warranty.

Printed in Thailand



Sony Electronics Inc. exclusivement pour les achats effectués aux États-Unis et Sony du Canada Ltée. exclusivement pour les achats effectués au Canada (collectivement « Sony ») garantit ce produit contre les défauts de matériaux ou de fabrication pour le propriétaire d'origine et tous les propriétaires utilisateurs finaux suivants (« Vous » ou « Vos ») pendant la période définie ci-dessus et comme indiqué dans les présentes. Conformément à cette Garantie limitée, Sony, à son gré, (i) réparera le produit en utilisant des pièces neuves ou remises en état ou (ii) remplacera le produit par un produit neuf ou recertifié/remis en état du même modèle (ou similaire). Aux fins de la présente Garantie limitée, les termes « recertifié » ou « remis en état » désignent un produit ou une pièce qui a retrouvé ses spécifications d'origine. **En cas de défaut, ce sont Vos recours exclusifs.** Sony ne garantit pas le fonctionnement ininterrompu ou sans erreur du produit.

**Modalité :** Pendant la période définie ci-dessus à compter de la date d'achat du produit directement chez Sony ou un vendeur autorisé Sony (pour déterminer si un vendeur fait partie du réseau de vendeurs autorisés de Sony, veuillez visiter, pour les É.-U. : [www.sony.com/retailers](http://www.sony.com/retailers); pour le Canada : <https://dealerlocator.sony.ca/locator>; ou contactez Sony directement), Sony, à son gré, réparera ou remplacera par un produit ou une pièce recertifié(e) ou remis(e) en état tout produit ou pièce défaillant(e).

Cette garantie limitée couvre uniquement les composants matériels emballés avec le produit. Elle ne couvre pas les accessoires séparés, l'assistance technique pour l'utilisation du matériel ou du logiciel et elle ne couvre pas les produits logiciels contenus ou non dans le produit, et tout autre contenu inclus; tout logiciel ou autre contenu inclus est fourni « EN L'ÉTAT » sauf indication contraire conformément à la Garantie limitée du logiciel joint ou à la Licence d'utilisation de l'utilisateur final. Veuillez vous reporter à la Licence d'utilisation de l'utilisateur final incluse avec le produit pour connaître vos droits et obligations en ce qui concerne le logiciel ou tout autre contenu inclus. Si vous avez acheté un plan de services étendu, veuillez vous reporter au plan de services pour connaître l'étendue de la couverture, la durée et les conditions d'utilisation. Les plans de services étendus ne sont pas régis par cette Garantie limitée.

**Pour obtenir un service de garantie,** vous devez livrer le produit, dans son emballage d'origine ou un emballage offrant un niveau de protection équivalent, à un centre de service autorisé Sony accompagné du reçu d'achat daté afin d'accéder au service de garantie. Sony n'est pas en mesure de garantir la réparation d'un produit au titre de ladite garantie ou l'échange d'un produit sans risque d'altérer le logiciel ou de perdre des données. **Il relève de votre responsabilité de retirer ou sauvegarder tout média ou toute pièce amovible, toutes données, tout logiciel ou autre matériel stocké ou conservé sur votre produit. Il est probable que tout média ou toute pièce, toutes données, tout logiciel ou autre matériel (comme des images, de la musique, des vidéos, etc.) soit perdu ou reformaté pendant le service et Sony ne pourra être tenu pour responsable dudit dommage ou de ladite perte.** Contactez les services suivants pour des instructions spécifiques sur la façon d'obtenir un service de garantie pour votre produit :

#### Pour les achats effectués aux ÉTATS-UNIS :

Visitez le site Web Sony : [www.sony.com/support](http://www.sony.com/support)

Ou appelez le centre d'expérience client : 1-800-222-SONY (7669)

Pour enregistrer votre produit ou obtenir des coordonnées pour acheter des accessoires ou des pièces, rendez-vous sur le site Web Sony

#### Pour les achats effectués au CANADA :

Visitez le site Web Sony : [www.sony.ca/support](http://www.sony.ca/support)

Ou appelez le centre d'expérience client : 1-877-899-SONY (7669)

Pour enregistrer votre produit ou obtenir des coordonnées pour acheter des accessoires ou des pièces, rendez-vous sur le site Web Sony

Un service sur place pour les téléviseurs de certaines dimensions est disponible pour les clients vivant dans un rayon de 50 km d'un local de service Sony autorisé, à condition que le lieu de résidence soit accessible à un véhicule de service.

**Garantie de réparation/remplacement :** Cette Garantie limitée s'applique à toute réparation, pièce de rechange ou tout produit de remplacement, recertifié ou remis en état pendant la période restante de la Garantie limitée d'origine ou pour une période de quatre-vingt-dix (90) jours, la plus longue date étant celle retenue. Toute pièce ou tout produit remplacé(e) au titre de ladite Garantie limitée sera la propriété de Sony. Tout produit de remplacement, recertifié ou remis en état fourni au titre de ladite Garantie limitée peut, au gré de Sony, être de couleur et/ou d'aspect différent par rapport au produit d'origine et peut ne pas inclure de gravure d'origine ou une personnalisation similaire.

Sony n'est pas responsable de, et ladite Garantie limitée ne couvre pas, tout dommage survenu suite à une utilisation du produit ne respectant pas ses utilisations prévues, ou autrement le non-respect du manuel du propriétaire et des consignes de sécurité se rapportant à l'utilisation et à l'installation du produit. Sony ne pourra être tenue responsable des frais liés à la main-d'œuvre ou à l'achat de pièces payés suite à une réparation ou des services offerts par un centre autre que ceux dûment autorisés par Sony. Ladite Garantie limitée couvre uniquement les dommages causés au produit par des défauts de matériaux ou de fabrication pendant son utilisation normale par le client. Ladite Garantie limitée ne couvre pas les produits achetés auprès de sources autres que Sony ou un vendeur autorisé Sony (y compris les ventes aux enchères en ligne non autorisées), ou les dommages causés par : (i) une exposition extérieure et d'autres actes de la nature; (ii) les surtensions; (iii) un dommage accidentel; (iv) un abus; (v) les limites de la technologie; (vi) un dommage cosmétique; (vii) le contact avec un liquide, la chaleur, l'humidité ou la sueur, le sable, la fumée ou des matériaux étrangers; (viii) les dommages, défaillances et/ou tout fonctionnement incorrect du produit suite à une réparation effectuée avec des pièces ou fournitures n'étant pas vendues ou autorisées par Sony; (ix) les dommages, défaillances et/ou tout fonctionnement incorrect du produit suite à des services non offerts ou autorisés par Sony ou un centre autre que ceux dûment autorisés par Sony; (x) les virus informatiques ou circulant sur Internet, les bogues, les vers ou les chevaux de Troie; (xi) les dysfonctionnements dus à des périphériques/accessoires; (xii) les modifications apportées à une pièce du produit, incluant l'enracinement ou toute autre modification visant à contrôler le comportement du produit ou tout système d'exploitation installé à l'usine; (xiii) les consommables comme les batteries; ou (xiv) tout produit dont le numéro de série appliqué à l'usine a été altéré ou retiré du produit. En outre, dans la mesure où ledit produit requiert l'utilisation d'un écran, veuillez noter qu'un écran contient des centaines de milliers de pixels individuels, et les écrans contiennent généralement un petit nombre de pixels qui ne fonctionnent pas correctement. Ladite Garantie limitée ne couvre pas les défauts de pixels à hauteur de 0,01 % (petits éléments d'image sous forme de points sombres ou mal éclairés).

Ladite Garantie limitée ne couvre pas les produits Sony vendus « EN L'ÉTAT » ou « AVEC DÉFAUTS » ou les consommables (comme les fusibles ou les piles jetables). Sony ne remplacera pas les composants manquants d'un emballage acheté comme « Boîte ouverte » ou « EN L'ÉTAT ». Ladite Garantie limitée est valide uniquement aux États-Unis et au Canada (selon le cas).

**LIMITATIONS DES DOMMAGES-INTÉRÊTS :** SONY NE PEUT PAS ÊTRE TENU RESPONSABLE DES DOMMAGES ACCESSOIRES OU CONSÉCUTIFS RÉSULTANT DE L'INEXÉCUTION D'UNE GARANTIE EXPRESSE OU IMPLICITE OU D'UNE CONDITION SUR CE PRODUIT. TOUT RECouvreMENT DE SONY NE POURRA PAS EXCÉDER LE PRIX D'ACHAT D'ORIGINE DU PRODUIT VENDU PAR SONY OU UN VENDEUR SONY AUTORISÉ.

**DURÉE DES GARANTIES OU DES CONDITIONS IMPLICITES :** SAUF DANS LA MESURE OÙ CELA EST INTERDIT PAR LA LOI EN VIGUEUR, TOUTE GARANTIE IMPLICITE DE VALEUR MARCHANDE OU D'ADAPTATION À UN USAGE PARTICULIER SUR CE PRODUIT EST LIMITÉE À LA DURÉE DE LADITE GARANTIE LIMITÉE.

Certaines juridictions n'autorisent pas l'exclusion ou la limitation des dommages accessoires ou consécutifs, ou autorisent les limitations de durée d'une garantie implicite, ainsi les limitations ou exclusions ci-dessus peuvent ne pas s'appliquer à vous. Ladite Garantie limitée vous octroie des droits spécifiques reconnus par la loi et vous pouvez bénéficier d'autres droits qui varient d'une juridiction à une autre.

**Pour les achats effectués aux États-Unis :** Lisez attentivement la clause de résolution/d'arbitrage des litiges suivante. Vos droits et les étapes à suivre en cas de litige lié au produit y sont détaillés.

**Que se passe-t-il en cas de litige :** En cas de litige ou de réclamation lié(e) au produit, à votre achat et/ou à l'utilisation du produit, aux clauses de ladite Garantie limitée, ou à un service fourni conformément aux conditions de ladite Garantie limitée (incluant une réparation ou un remplacement) (« Litige »), vous et Sony acceptez que le litige soit résolu exclusivement à travers un arbitrage exécutoire. VOUS COMPRENEZ ET RECONNAISSEZ QU'EN ACCEPTANT L'ARBITRAGE VOUS AVEZ LE DROIT D'INTENTER UNE ACTION EN JUSTICE POUR (OU DE PARTICIPER EN TANT QUE PARTIE OU MEMBRE DU RECOURS À) LA RÉSOLUTION DES LITIGES DEVANT UN TRIBUNAL. Vous acceptez également que TOUTE PROCÉDURE DE RÈGLEMENT DES DIFFÉRENDS CONSIDÉRERA UNIQUEMENT VOS REVENDICATIONS INDIVIDUELLES, ET LES DEUX PARTIES ACCEPTENT QU'UN LITIGE NE SOIT PAS ENTENDU COMME UN RECOURS COLLECTIF OU UN RECOURS DU PROCUREUR GÉNÉRAL. Malgré les indications ci-dessus, vous avez le droit d'intenter une action en justice de manière individuelle devant la Cour des petites créances ou une Cour similaire à la compétence limitée, dans la mesure où le montant en question n'excède pas 15 000 \$, et aussi longtemps que la dite Cour soit compétente et que toutes les autres exigences (incluant le montant en litige) soient satisfaites.

**Consignes d'arbitrage.** Pour commencer l'arbitrage, vous ou Sony devez faire une demande d'arbitrage écrite à l'autre partie. L'arbitrage aura lieu devant un seul arbitre. L'arbitrage sera géré en suivant les Procédures accélérées des Règles d'arbitrage commercial et les Procédures additionnelles (les « Règles ») de l'association américaine d'arbitrage (« AAA ») pour les différends de consommateur, si elles sont applicables et en vigueur au moment où la réclamation est traitée. Vous pouvez demander une copie des Règles de l'AAA en contactant l'AAA au (800) 778-7879 ou en visitant le site Web [www.adr.org](http://www.adr.org). Les droits de dépôt pour commencer et mener l'arbitrage seront partagés entre vous et Sony, mais vos frais ne devront en aucun cas excéder le montant permis par les règles spécifiques de l'AAA pour les Différends de consommateur, après quoi Sony couvrira tous les frais administratifs et dépenses additionnels. Ce paragraphe n'interdit pas à l'arbitre de restituer à la partie ayant obtenu gain de cause les frais et dépenses qu'elle a engagés dans l'arbitrage lorsque les Règles le permettent. Sauf si Sony et vous en conveniez autrement, l'arbitrage aura lieu dans le pays et l'État où vous vivez, et la loi fédérale ou d'État applicable régira le fond du différend pendant l'arbitrage. Cependant, la Loi sur l'arbitrage fédéral 9 U.S.C. § 1, et seq., régira l'arbitrage et non une quelconque loi d'État sur l'arbitrage. La décision de l'arbitre sera obligatoire et définitive, sauf dans le cadre d'un droit d'appel limité conformément à la Loi sur l'arbitrage.

**Consignes d'exclusion. SI VOUS NE SOUHAITEZ PAS ÊTRE CONTRAINT PAR LA CLAUSE D'ARBITRAGE OBLIGATOIRE, ALORS :** (1) Vous devez en informer Sony par écrit dans les 30 jours à compter de la date d'achat du produit; (2) Votre notification écrite doit être envoyée par courrier à Sony Electronics Inc., 16535 Via Esprillo, MZ 1105, San Diego CA 92127, à l'attention de : Service juridique; ET (3) Votre notification écrite doit inclure (a) votre NOM (b) votre ADRESSE, (c) la DATE d'achat du produit, et (d) une déclaration claire stipulant que « VOUS NE SOUHAITEZ PAS RÉSOLVRE LES DIFFÉRENDS AVEC UNE ENTITÉ SONY ELECTRONICS À TRAVERS L'ARBITRAGE ET/OU ÊTRE CONTRAINT PAR LA RENONCIATION À INITIER OU PARTICIPER À UN RECOURS COLLECTIF ».

Décider de ne pas adhérer à cette procédure de résolution des différends n'affectera en aucun cas la couverture de la Garantie limitée et vous continuerez à bénéficier des avantages de la garantie limitée.