

AV Center

2-DIN DVD Head Unit

2 DIN 10.6" Monitor
Touch screen
DVD/CD/MP3/MP4
USB/SD
AM/FM Radio
Support Apple CarPlay™
Support Android Auto™
Support Bluetooth

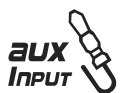

Content

1. Appearance	3
2. Accessories and Installation	3
3. Wiring Connection	5
4. Front panel Description	7
5. Remote Control	8
6. Main Menu	9
7. Settings	9
8. Apple CarPlay & Android Auto	12
9. Radio	13
10. USB	14
11. Disc	15
12. BT Audio	16
13. BT Phone	17
14. Specification	19
15. AV IN	20
16. Camera	20
FCC Notes	21

1. Appearance

Appearance

Main Menu

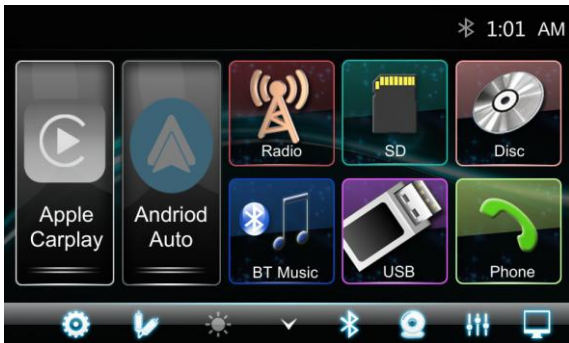

Apple Carplay Menu

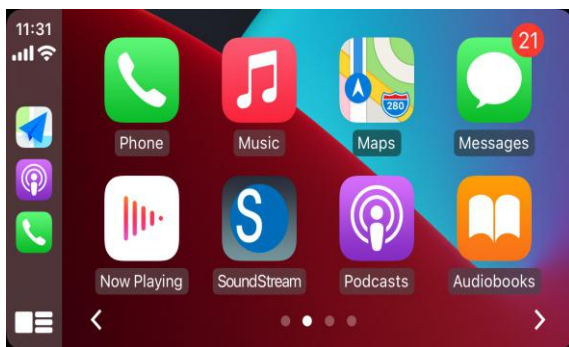

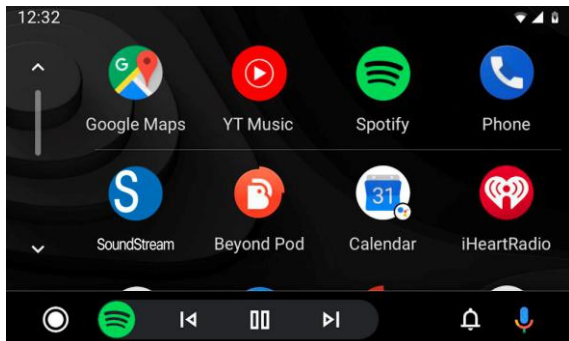

Android Auto Menu



2. Accessories & Installation

Accessories & Installation

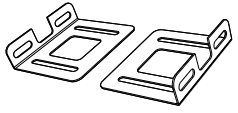
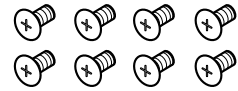
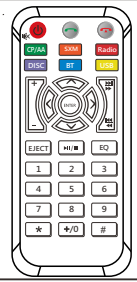
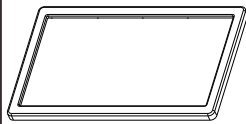
Package contains the following accessories for installation and operation of the unit.

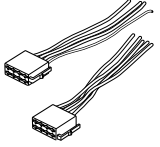
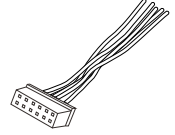
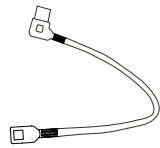
(1) Mounting bracket	2	
(2) Screw	8	
(3) Remote	1	
(4) Trim Ring	1	
(5) User Manual	1	
(6) Warranty Card	1	
(7) ISO Cable	2	
(8) Harness cable	1	
(9) USB cable	1	

2. Accessories & Installation

Installation

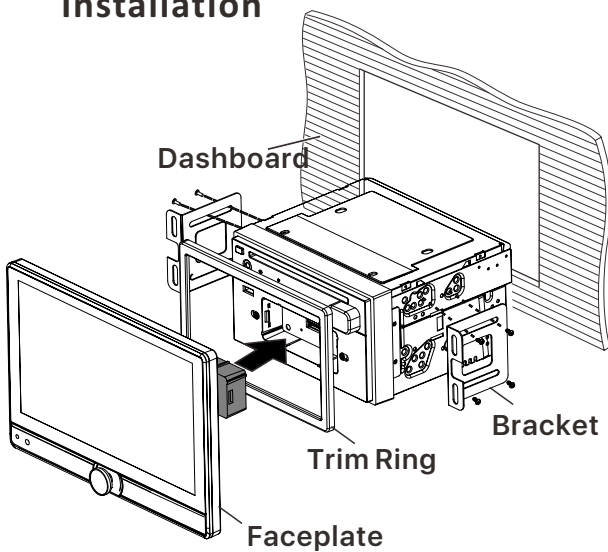

1. Put the 2 brackets to the left and right side of the headunit.
2. Use screws to fix the brackets to the unit.
3. Install the body chassis into the dashboard via the 2 brackets.
4. Install the trim ring to the body chassis.
5. Install the faceplate.

Note: Please note this faceplate is not designed for detachable.

Disconnect / Connect the screen connector ONLY for installation in the vehicle.

Note:

1. Make sure the ignition is turned off, and disconnect the cable from the vehicle battery's negative (-) terminal.
You never want electricity running when you install this 2-DIN car receiver.
2. Before installation, disconnect the wire harness and the antenna.
3. Attach the brackets on the both sides of the car receiver with screws as shown as the installation drawing. Please buy from your dealer according to the drilling of holes size.

4. Consult with your nearest dealer if installation requires the drilling of holes or other modification of the vehicle.
5. Install the car receiver in the dashboard.
6. Connect the wire harness & antenna to the car receiver being carefully not to pinch any wires or cables.
7. Install the plastic outer trim ring onto the car receiver.
8. Reconnect the battery and run through all of the options on this car receiver to ensure that everything is working correctly.
9. Particulars will vary widely depending upon the kind of your car and the car you intend to install it in. Please choose the correct installation method according to the actual situation of your car. Always contact the car dealer or manufacturer if you have any questions.

Faceplate Adjustable Position

1. Vertical

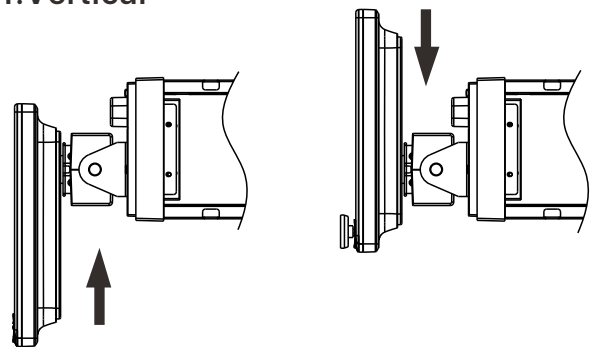

2. Tilt

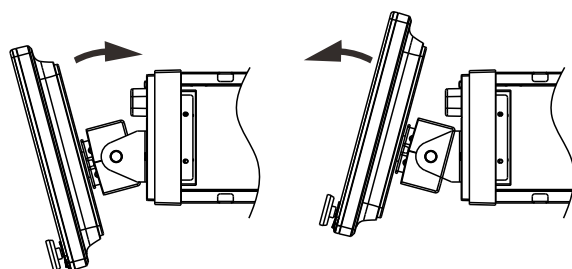

3. Wiring

3. Swivel

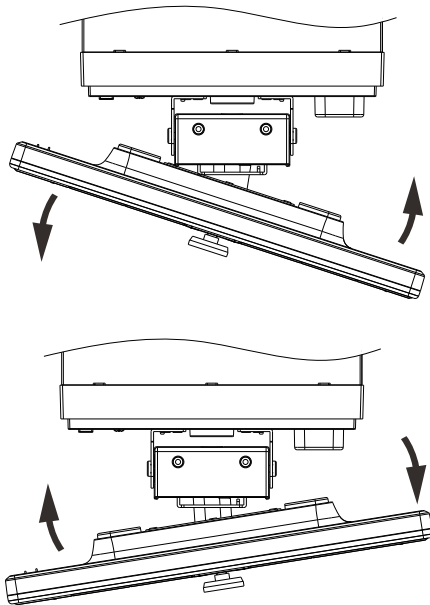

Un-Installation

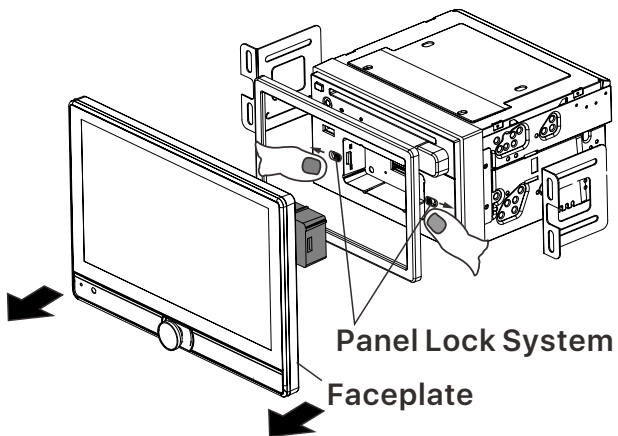

1. Pull and release the panel lock system.
2. Pull out the faceplate.

Note: Please note this faceplate is not designed for detachable. Disconnect / Connect the screen connector **ONLY** for installation in the vehicle.

Parking wire

Note: The parking wire is connected with brake signal; for safety, the programs can be seen on the monitor after braking the car..

Note: To watch video the parking wire should be connected to brake signal.

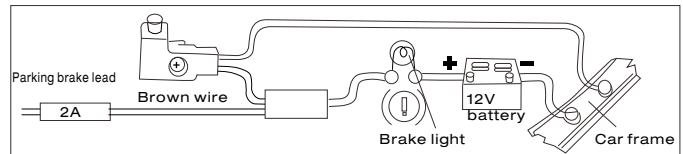

Connecting the reversing line to taillight on the car

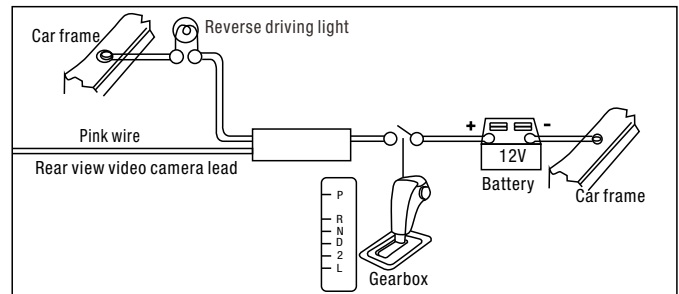

After connecting, when you start up the reverse gear, the unit will receive the picture from car rear view camera.

Speaker Connection

Connect the speakers according the following diagram, incorrect connections will damage the unit or your loudspeakers

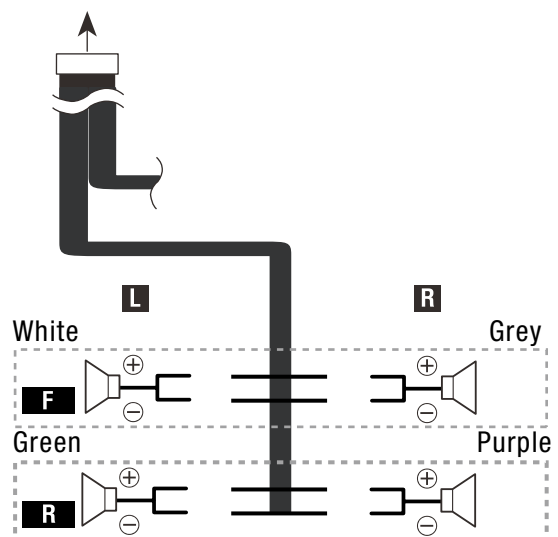

3. Wiring

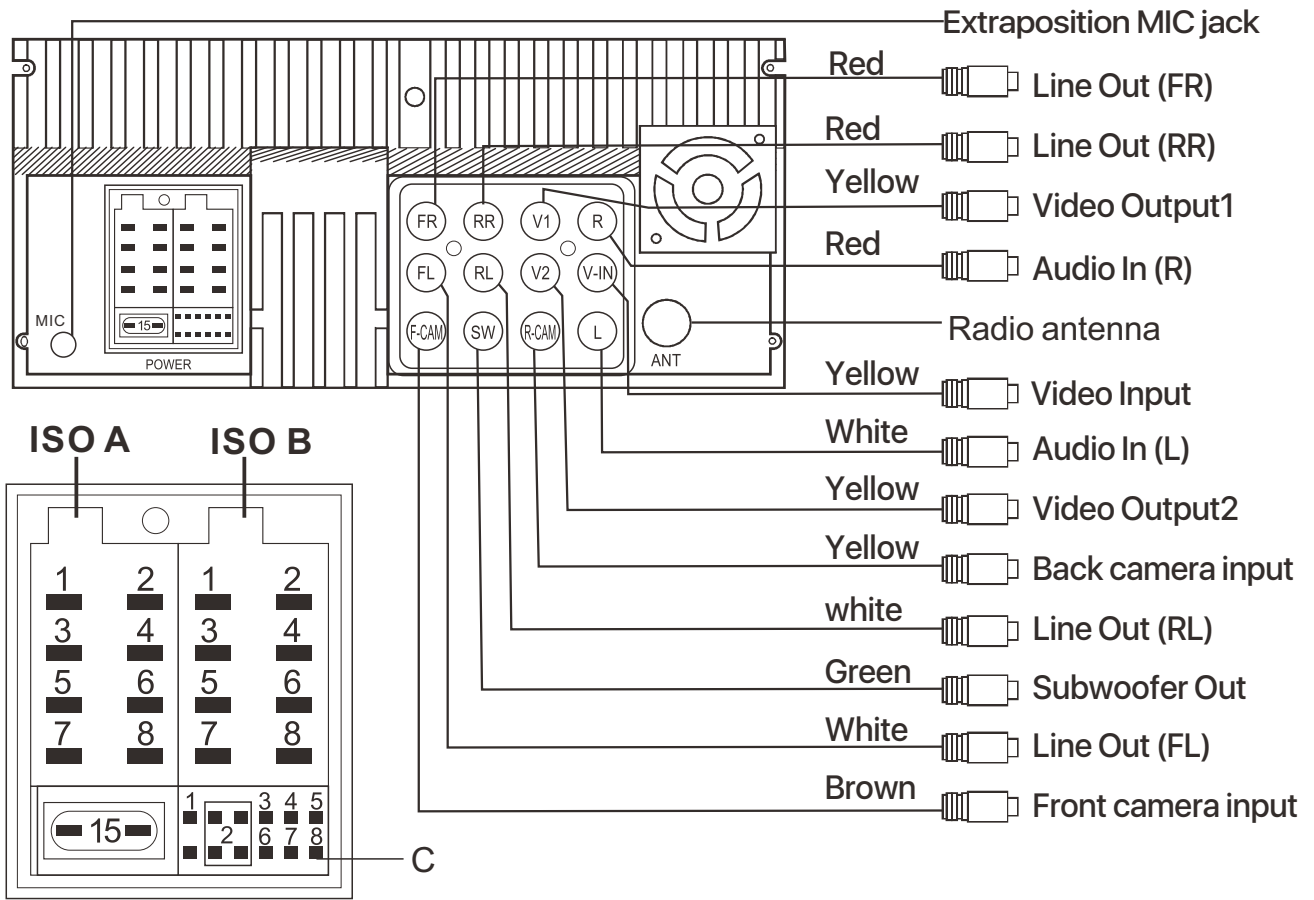

Portion		Colour	Connection
ISO A	A3	Yellow	Battery B+
	A5	Orange	ILL B+
	A6	Blue	Antenna
	A7	Black	Ground
	A8	Red	ACC B+
ISO B	B2	Purple	Rear right speaker(+)
	B1	Purple / Black	Rear right speaker(-)
	B4	Grey	Front right speaker(+)
	B3	Grey / Black	Front right speaker(-)
	B6	White	Front left speaker(+)
	B5	White / Black	Front left speaker(-)
	B8	Green	Rear left speaker(+)
B7	Green / Black	Rear left speaker(-)	
8 Pin connector	C1	Blue / White	Amplifier control(B+)
	C3	Brown	Brake detect (Ground)
	C4	Pink	Back car control(Back camera B+)
	C5	Pink / Black	Front camera(B+)
	C6	Black	Ground
	C7	Green	Steering Wheel 2
	C8	Grey	Steering Wheel 1

4. Front panel Description

Front panel

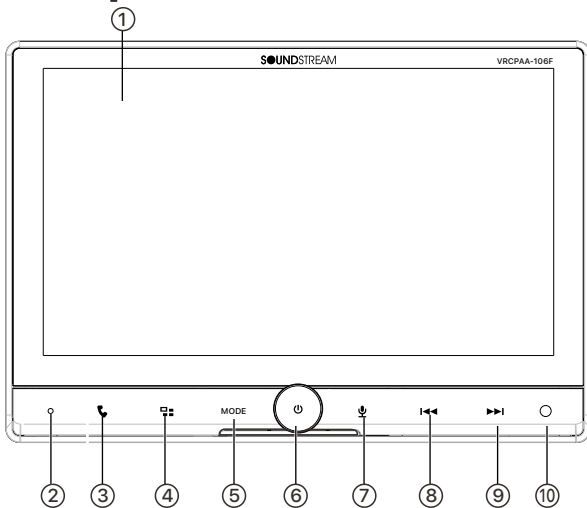

① 10.6 inch TFT LCD

② Mic
Build in Microphone.

③ Bluetooth button
Touch to access to Bluetooth mode.

④ MENU button
Touch to back to Main menu.

⑤ MODE button
Touch to select desired mode.

Rotary Control
On/Off button
Short press to switch On the source unit.
Long press to switch Off the source unit.

⑥ In operation, short press to Mute the sound system, press again to Un-Mute.
In operation, rotate to adjust the sound output level.

⑦ Siri button
When Apple CarPlay or Android Auto available, hold Siri button to start the voice control function.

⑧ ◀▶ button
[Radio] Press to select previous/next preset radio station for broadcasting.

Press and hold to seek downward or upward.

[Disc/USB/SD Music] Press repeatedly to shift track previous or next for playback.
Press and hold to active various fast rewind or fast forward speeds for playback.
[Bluetooth Music] Press repeatedly to shift track previous or next for playback.

⑩ IR Sensor of Remote
IR remote control signal receiving window.

Base:

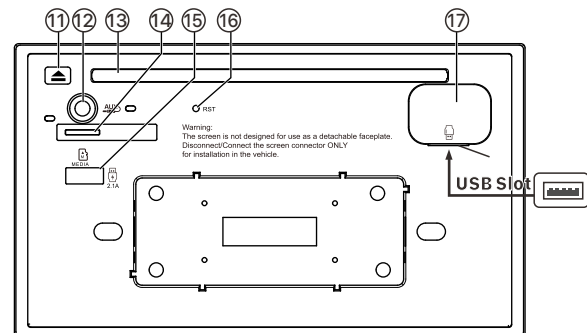

⑪ Eject Button
Press to eject the disc.

⑫ AUX in jack
Insert an external device to this port in order to have sound output of that external device through the unit.

⑬ Slot-in
Insert or eject the the disc.

⑭ Micro SD slot
Insert micro SD for playback.

⑮ Fast charging USB port
Support fast charge USB port.

⑯ Reset button
Press to default factory settings.

⑰ USB port
Connect USB for digital playback. Connect your iPhone for Apple CarPlay.
Connect your Android Phone for Android Auto.

5.REMOTE CONTROL

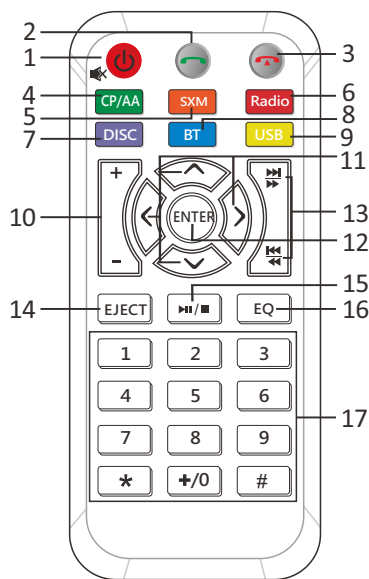



1.  Press and hold to power it on or off. Short press this button mute the volume output when unit turn on. Long press is Power OFF function when unit turn on.

2.  [Bluetooth]: Press it to make a call after inputted a phone number or answer an incoming call.

3.  [Bluetooth]: Press it to reject a coming call or hangup while calling

4.  Press it to switch to CarPlay or Android Auto mode; Head Unit will show string "invalid operation" when CP/AA is not plugged in Head Unit.

5.  Press it to switch to SXM mode.

6.  Press it to switch to RADIO mode.

7.  Press it to switch to DVD mode.

8.  Press it to switch to Bluetooth mode.

9.  Press it to switch to USB mode.

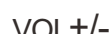
10.  Press it to increase or decrease the volume level.

11.  It is UP /Down/Left/Right Arrow, use this button to select the menu item, the title track or to show next frame. [Radio] Press to seek upward/downward.

12.  Press it to confirm selection.

[Radio] Press to select next/previous preset radio station for broadcasting.



13.  [DVD/USB/SD]: short press it to skip to the next track or previous functions. Long press to activate fast forward or fast review in a track. [Bluetooth Music]: short press it to skip to the next track or previous functions.

14.  Press it to eject the disc.

15.  [DVD/USB/SD]: short press it to switch play or pause.

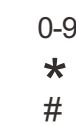
16.  Press it to Equalizer functions .

17.  **0-9** [Radio]: Select 1-6 desired preset station.
***** [DVD/SUB/SD]:Input 0-9 for selecting track number.
[BT Phone]:Input 0-9/*/# for desired phone number.

Note: 1. SXM just for include SiriusXM function models.
 2. * #   these functions for Bluetooth.

6.MAIN MENU

VRCPAA-106F is a 2-DIN car audio with following functions:

Apple CarPlay, Google Android Auto, Radio, Disc, Bluetooth, USB, SD.





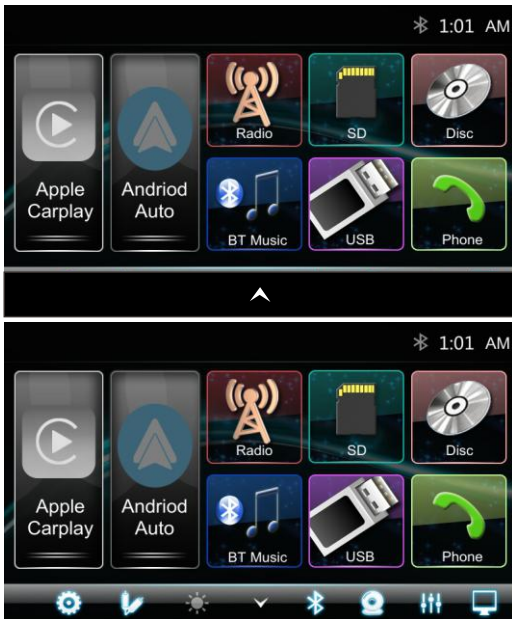



The Mode icon in gray means the corresponding function is not ready or proper device have not been connected.

Touch the corresponding Mode icon to enter playing mode.



Hidden soft button bar

A hidden pop up soft button bar is located at the bottom. Touch the icon ▲ to shown the soft button bar. Touch the ▼ to hidden.

-  Hidden the pop up soft button bar.
-  Pop up the soft button bar.
-  Setup, to enter the Settings Menu.
-  AUX IN, to enter the AUX and A/V IN interface
-  Dimming, to change Daylight or Night (If lighting detect is OFF in Display Setting)
-  Bluetooth pairing.
-  Front Camera, to enter the front camera.
-  EQ, to enter the Equalizer setting mode.
-  Turn off TFT display.
TFT enter black mode touch any zone return to TFT on.

7.Settings

Touch the  icon to enter the Setup menu.

The Setup menu is included System Settings, Display Settings, Audio & EQ Settings, Disc & DVD Settings, Bluetooth Settings and Rear Camera Settings

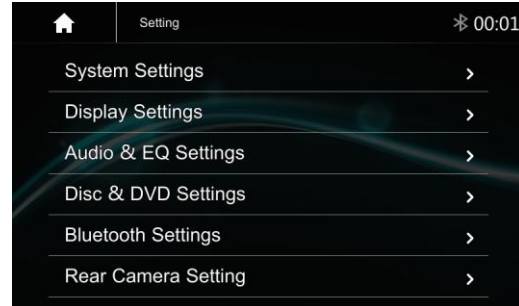

System Settings

The System Settings allow the user to set up the Language, Date & Time, Key Beep, SWC, Factory Reset and About

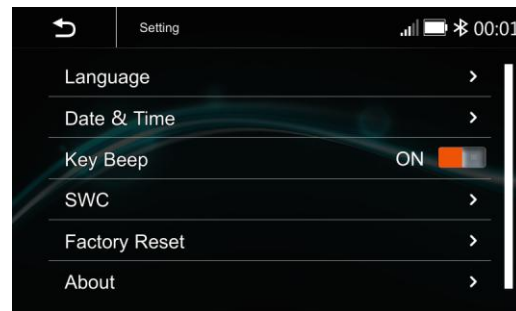

Language

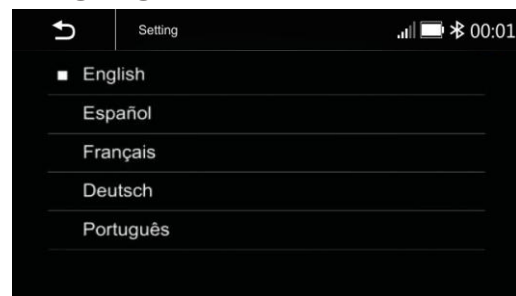

Date & Time:

To setting Time display format (12H or 24H), setting the date and time

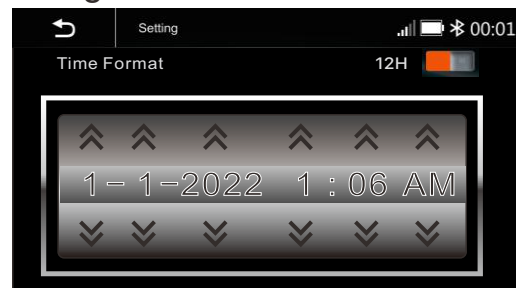

Beep Tone: On/Off

To set the touch button beep tune On or Off

7.Settings

SWC:

To set the Steering Wheel Control

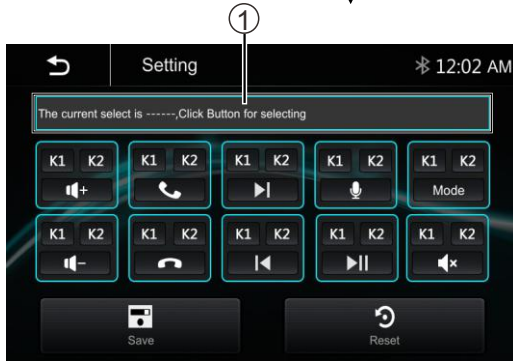
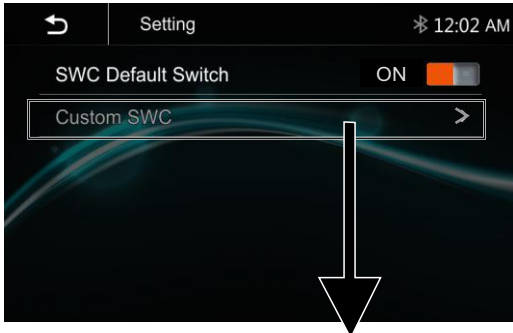

Click Custom SWC to SWC study mode.



Click SWC Default Switch to be "on" status.



Touch Save to confirm the setting



Touch Reset to erase and reset the setting

①

Short time press the key of the car radio SWC screen first and then long time press corresponding button of car steering wheel for learning and setting.

Note: Press the "Reset" before you start the setting.

Factory Reset

To reset the default factory setting.

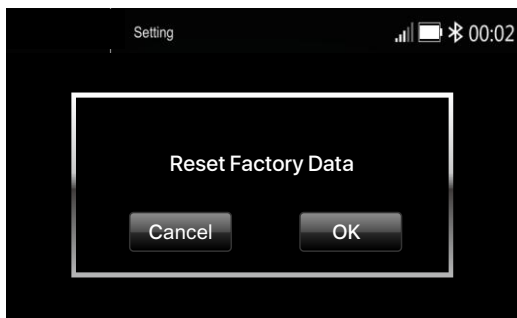

About

To display the Unit Hardware and Firmware version.

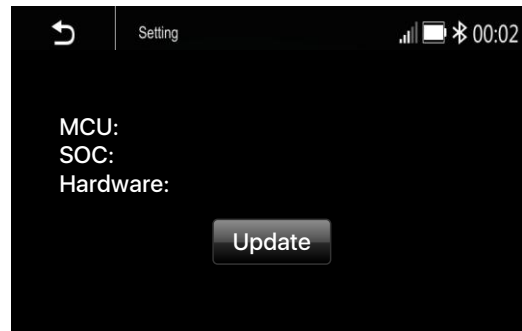

Display Settings:

Below is the Display setting menu, user can select Lighting Detect, Daylight Dimming Level, Night Dimming Level, Illumination and Wallpaper.



Lighting Detect: On/Off

Daylight Dimming Level: 8 – 15

Night Dimming Level: 0 – 8

Illumination

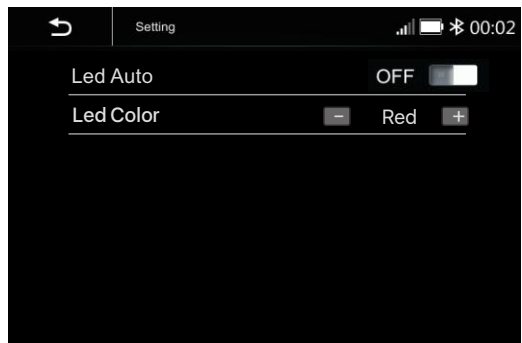

Led Auto: On/Off .

ON: The Led color will change automatically.

OFF: You press the button or to select desired color.

Color: White / Red / Yellow /Blue / Green / Purple / Light Green

7.Settings

Wallpaper

User can select the preset wallpaper or select the picture in USB driver as the wallpaper.

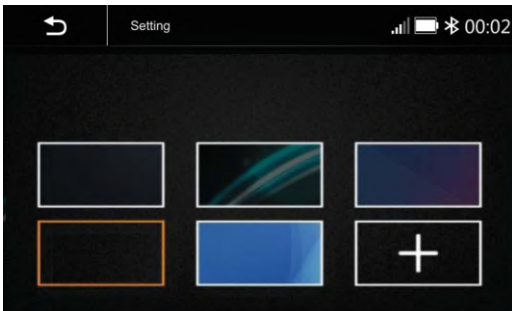

Touch the corresponding picture to select the prefer background.

Touch " + ", the head unit will search the USB photo file for wallpaper.

Select a picture and touch OK to add the wallpaper.

Audio & EQ Settings:

Below shown is the Audio Setting Menu.



Balance/Fader:

Touch the + or – of Balance/Fade to tune for the driver and passenger preference.

The value of Balance (Left 12 – Right 12) and Fade (Front 12 – Rear 12)

Touch Reset to set both Balance and Fade to zero.

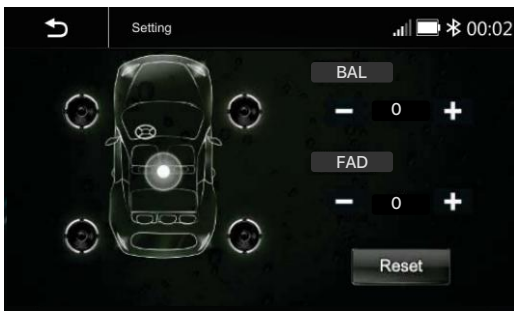

Subwoofer Output: On/Off

Subwoofer Filter: 50Hz/ 80Hz/
120Hz/ 160Hz

Subwoofer Level: -10 – +10

10-Band Equalizer :

10 band of EQ tuning, slide the EQ bar to tune each band frequency level according to user preference.

Touch Reset to set all Band to 0.

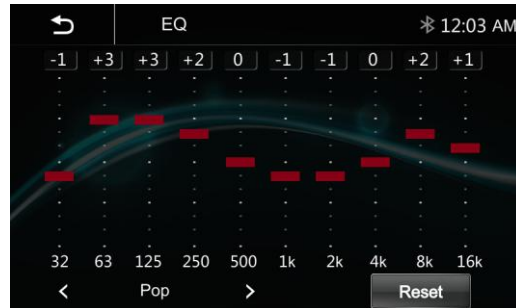

Or user can touch " < " or " > " at the bottom to select the following preset EQ:
off/ Soft Rock/ Pop/ Electric/ Jazz/ EQ Custom.

LOUD: On/Off

Disc & DVD Settings :

Touch the Disc/DVD Settings from the menu to enter the Disc/DVD setting interface.

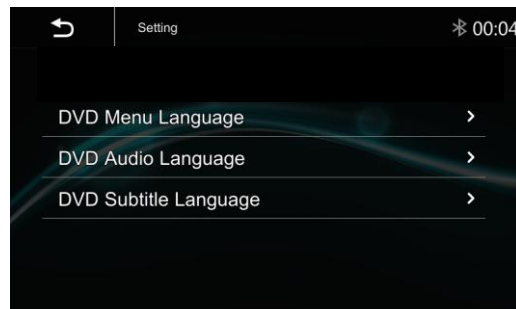

Touch to select the desired language.

Bluetooth Settings :

Touch the Bluetooth Settings from the setting menu will be shown below.



7.Settings

Connection: On/Off (Select Bluetooth connection on or off)

Pairing : (To start the pairing)

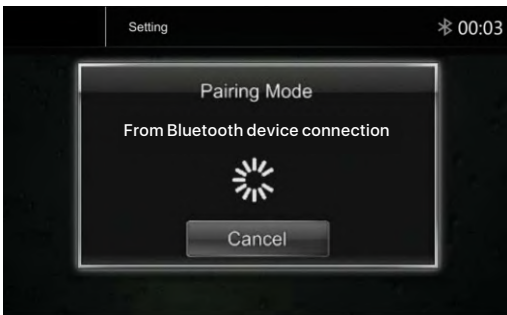

Device Name: shown the connected phone or device

Clear Records: (To clear the device list records)

Rear Camera Setting:

Touch Rear View Camera in the Setting Menu to enter rear camera setting interface as follow:

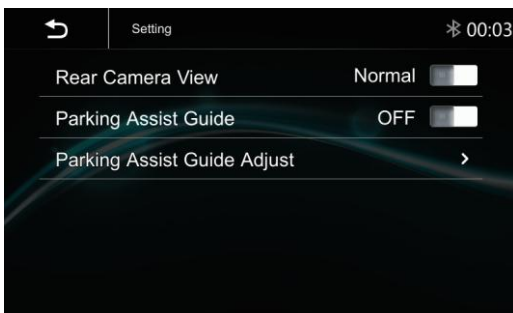

Rear Camera View: Normal/Reverse

Parking Assist Guide: On/Off

Parking Assist Guide Adjustment

Touch ">" to enter Parking Assist Guide Adjustment interface to show the below screen:

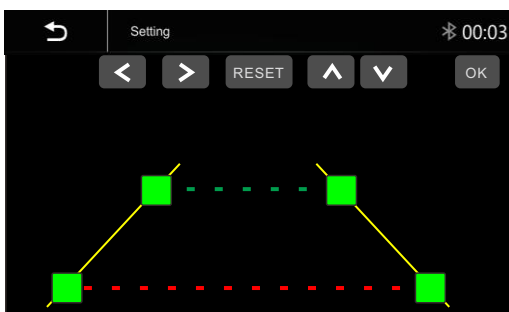

Select the adjust position and Touch < / > / ^ / v to adjust.

Touch OK to confirm.

Touch Reset to resume the default Parking Assist Line.

8.CarPlay & Android Auto

8.1 Apple Carplay

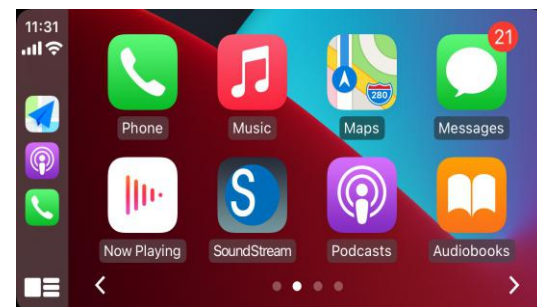
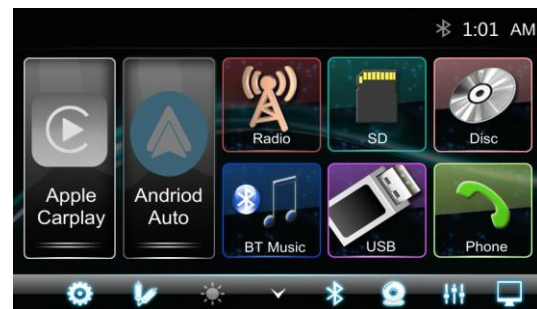

Plug the iPhone (iPhone 5 or latter models, and IOS 7.1 or above) through the lightening cable to the USB port of the source unit. The iPhone will be shown the "CarPlay". The source unit will enter the CarPlay interface, the APP that support the CarPlay feature will be displayed on the source unit as shown below. Touch the corresponding

APP can operate, touch  button to go back the CarPlay interface.



Siri

In Apple Carplay mode, user can talk to SIRI to

control the Apple CarPlay functions. Press  to start the SIRI function, or touch the  button for 2 seconds or the HOME button of iPhone. Now you can talk to Siri for playing music, I am going....

Note: For SIRI function in the source unit, the Micriphone has to be connected.

In CarPlay mode, touc"Home" button or

 icon to go back the main menu of source unit.

8.2 Android auto Operations

Android Auto enables you to use functions of your Android device convenient for driving. You can easily access route guidance, make calls, listen to music, etc. For details about Android Auto, visit <https://www.android.com/auto> or <https://support.google.com/androidauto>.

Compatible Android devices

You can use Android Auto with Android devices of Android version 5.0 or later.

Note: Android Auto may not be available on all devices and is not available in all countries or regions.

Operations:

1. Connect an Android device via USB terminal. To use the hands-free function, connect the Android device via Bluetooth. When an Android device compatible with Android Auto is connected to USB terminal, the device is connected via Bluetooth automatically, and the Bluetooth smartphone currently connected is disconnected.
2. Unlock your Android device
3. To enter Android Auto mode, touch Android Auto icon in the head unit screen. You can perform the operations of the Apps of the connected Android device.
4. In Android Auto model, touch "Home" to the head unit main menu.

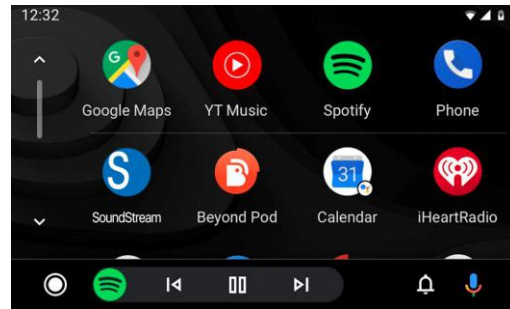
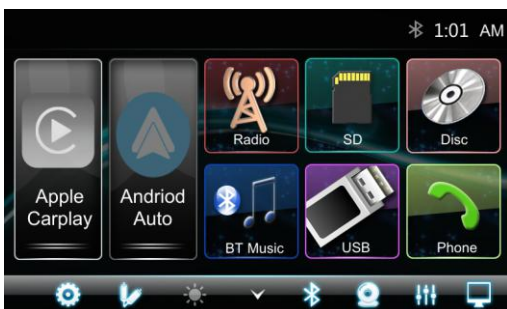

Radio mode

Touch the Radio mode icon to enter Radio.

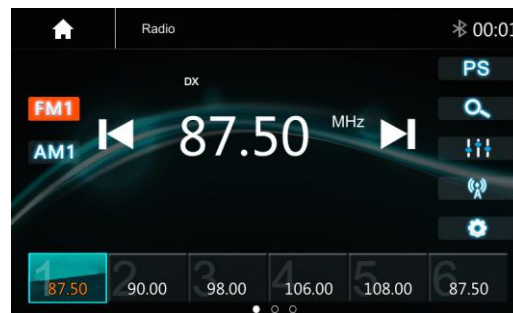
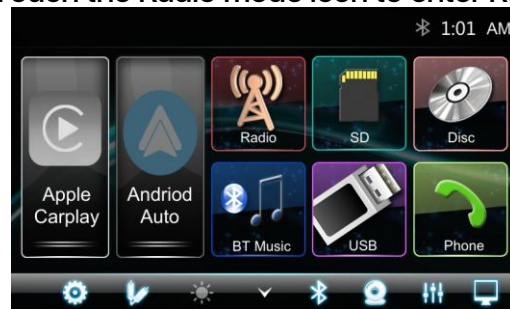

- FM1** Touch FM can change between FM1=>FM2=>FM3 .
- AM1** Touch AM can change between AM1=>AM2.
- PS** Touch for Prescan search, each scanned station will be play for 3 sec, touch again to stop.
- Search** Touch to auto scan searching.
- EQ** Touch to enter EQ settings.
- LOCAL/DX** Touch to switch LOCAL or DX.
- Settings** Touch to enter Radio settings.
- Seek-** Short touch to Seek-, long touch for Tune-
- Seek+** Short touch to Seek+, long touch for Tune+

Preset channel, Six preset buttons store and recall stations for each band. Touch and slide the preset channel can switch to next band FM1 / FM2 / FM3 or AM1 / AM2. Slide the frequency to Seek +/- to next station

10.USB

Store a Station

1. Tune radio to desired station.
2. Touch and hold the one of the preset station for more than 3 seconds, then the preset button will be highlighted on the screen, and the preset station will be stored.

Radio Setting



Radio Area: select the region, American/ Europe/Eastern Europe/ Japan/Southeast Asia/Latin America/Asia / Australia.

RDS: Switch ON or OFF.

TA: Switch ON or OFF.

AF: Switch ON or OFF.

PTY: Select PTY list.

Note: AF is only for Europe region.

USB

Plug the USB, the USB icon will be colorful. Touch the USB icon to enter the USB playback mode. The source unit default the play the Audio in the USB device.

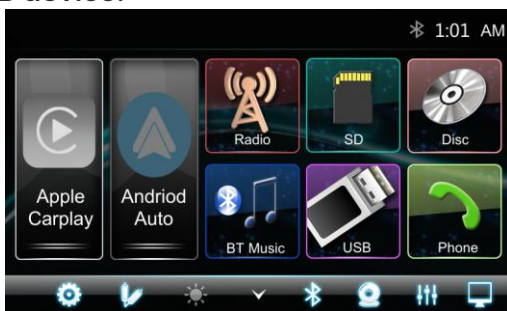

Press to go to the next folder.



Press to search Audio, Video or Picture files.



Press to go to the previous folder.



Short press to skip previous track, Long press to fast reverse.



Play or pause button.



Short press to skip next track, Long press to fast forward.



Press to select Repeat All > Repeat 1> Repeat folder> Repeat Off.



Press to switch Random is On or Off.



Press to select Audio setting or set the prefer EQ of each band in custom mode.

File List browsing

Support to play picture and video. If there is other multimedia files in the USB, touch to browse the folder and file list of the USB driver. Select the multimedia type

Touch  to browse the folder and file list of the USB device.

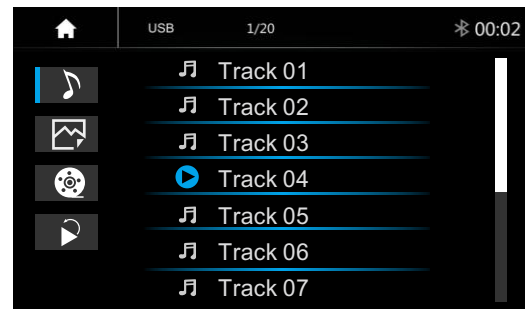

Select Audio or Music files.



Select Picture files.



Select Movie or Video files.



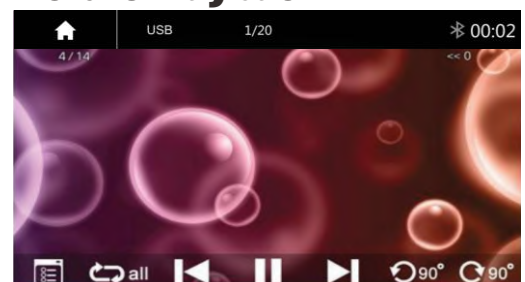

Return to playing previous file.

Picture Playback



11.DISC

 Touch to rotate the picture anti-clockwise for 90 degree (for picture playback)

 Touch to rotate the picture clockwise for 90 degree (for picture playback)

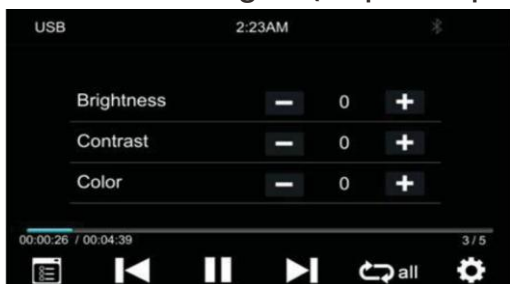

 Touch to set the video Brightness, Contrast and Color (for video playback)

DISC Inserting a Disc

Insert a Disc to the slot of the head unit, pull the disc or press the Eject button to make the disc into the deck. Touch the Disc to perform Disc playing function.

Ejecting a Disc

During disc playing or inside the deck, press the Eject button to stop playing the disc and eject the disc. After the disc is ejected and press the Eject button, the disc will go inside to the unit.

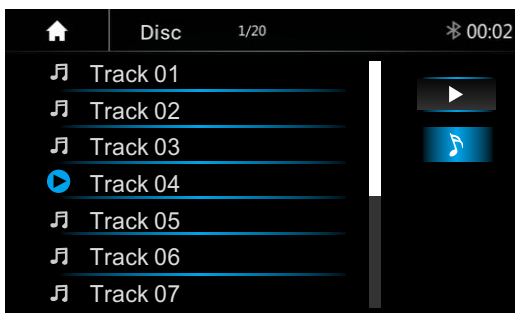
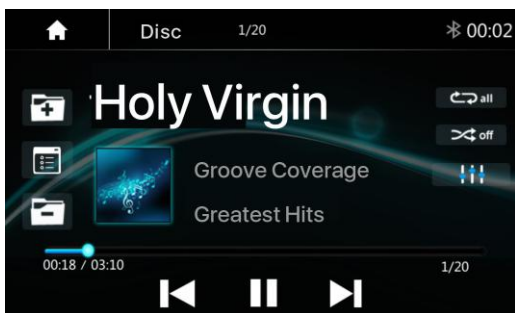

Note: The operation for buttons will be same as USB music playback.

DVD Playback



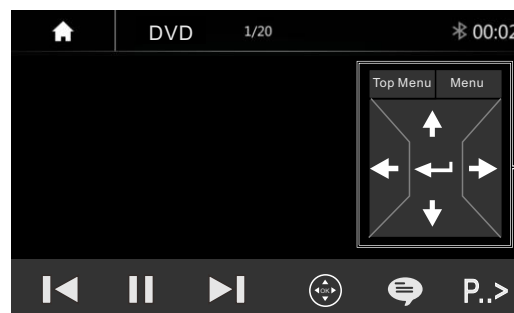
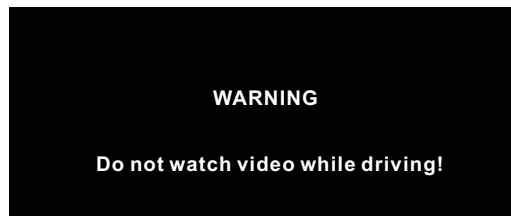



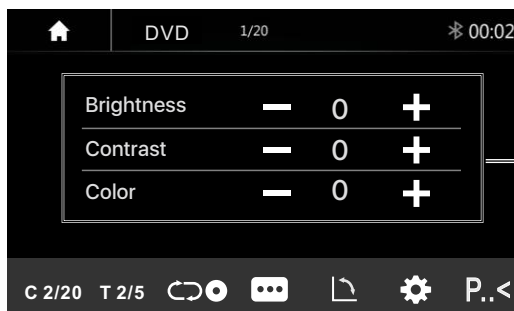





The Video display can be watched only during the Car is Parked.
Parking wiring: High level (+12v or NC) is driving; low level (ground) is parking.



Disc Menu button



settings

-  Short press it to skip to the previous track, long press it to fast reverse.
-  Pause/Play button.
-  Short press it to skip to the next track, long press it to fast forward.
-  Touch it to select subtitle language .
-  Touch to this button and touch again on screen to pop-up the disc menu.
-  Touch it to show the tools bar.
-  Touch it to select Chapter
-  Touch it to select Title.
-  Press it to select repeat All, Repeat One and Repeat Off
-  Touch it to select Sub-Title.
-  Touch it to change the viewing angle.
-  Touch it to hide the tools bar.

12. Bluetooth Audio

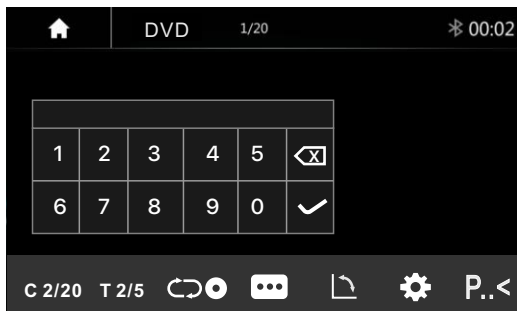

Direct search

1. Touch the button "C 1/2" or "T3/3" to select a chapter or title directly using the on-screen display direct entry menu display. Enter the Direct Search menu,
2. Enter the chapter or Title Digital, touch  to confirm.

Playing Multimedia Files in Disc

Source unit is supporting the below disc types and Multimedia file format.

Note:

the operation for buttons will be same as USB playback.

Bluetooth Music

Touch the BT Music icon to enter Bluetooth Music playing mode. If the Bluetooth is connected, the music will be playing as following shown:

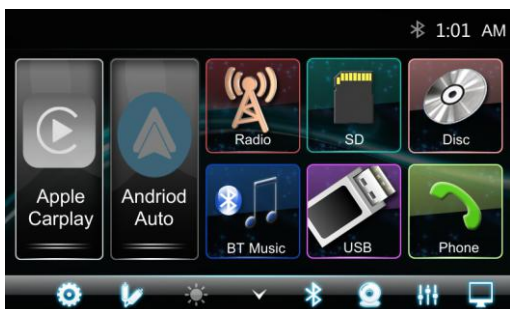

Bluetooth Music Playback

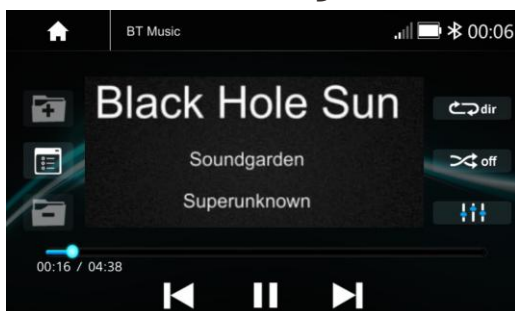

Press to go to the next folder.



Press to search Audio, Video or Picture files.



Press to go to the previous folder.



Short press to skip next track, Long press to fast forward.



Play or pause button.



Short press to skip next track, Long press to fast forward.



Press to select Repeat All > Repeat 1> Repeat folder> Repeat Off.



Press to switch Random is On or Off.



Press to select Audio setting or set the prefer EQ of each band in custom mode.

Bluetooth Connect

If the Bluetooth is not connected, press Re-connect the paired phone or pairing to pair the new device.



Bluetooth Pairing

Press Pairing the Pairing Mode screen will be shown as below:

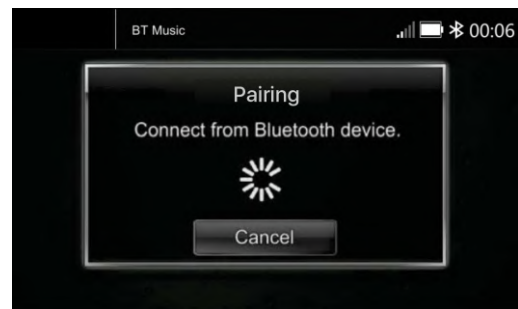

Turn On the Bluetooth of the Mobile phone/ Bluetooth device, you can see the VRCPAA-106F. Select the VRCPAA-106F for pairing and connection.

13. Bluetooth Phone

Bluetooth Phone

Touch the Phone icon in main menu to go to Phone mode. After the mobile phone is connected with the source unit via Bluetooth (HFP), user can through the source unit to make a phone call. Please note it needs to connect the microphone for phone call.

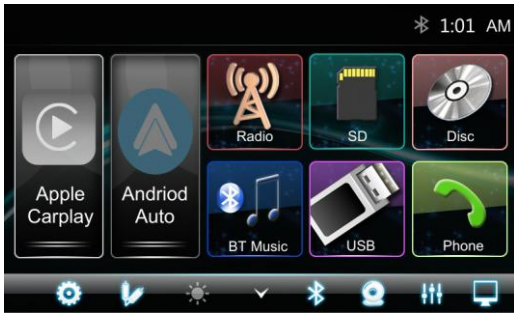

Keyboard. tap it to enter call mode.



History, to show the call record, missed, received and dialed calls



Contact, tap to show the phone-book connected phone.



BT Setup, to set auto answer and microphone gain.







Make a Call or Accept the Incoming Call.



Backspace, to clear the pervious dial digit.

Make a Call

1. Touch the  icon to enter below screen.
2. Using the keypad, touch 0-9,*,#, enter the phone number you wish to dial. If you input an incorrect number, touch the  icon on the keypad to delete the incorrect number.
3. Once the correct number appears on the screen, touch the  icon. To go to dialing interface.

4. To end the call, touch the icon  on the screen.



Receive an incoming call

If the Phone is connected with the source unit via Bluetooth, when an incoming call, below screen will be shown:



Press  to answer the incoming call.

Press  to reject the incoming call.

13. Bluetooth Phone



Interchange between phone and source unit



ON/OFF the Microphone function



Display the Keypad.

Call History

Touch the icon  to display the Call combined list.



Slide the bar at right side up and down to display a call logs up to 20 records.

Contacts

Touch the icon  to access the phone book of the connected mobile phone. To make a call from the phonebook, simply touch the contact name.



BT Setup

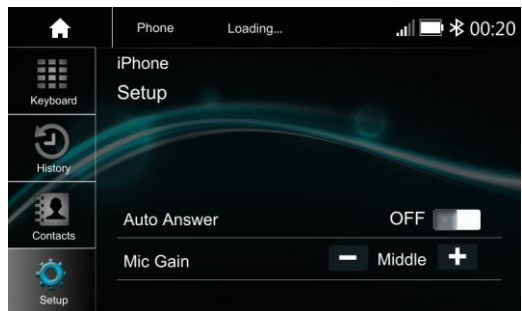

Auto Answer On /OFF, incoming call auto answer.

MIC Gain, Low / Middle / High

14. Specification

General

Power Supply	DC10~16Volts
Grounding System	Negative Ground
Current Drain	15A(Max.)
Max Power Output	4x75W/channel
RMS Power Output	4x25w/channel
Speaker Impedance	4~8ohms per channel
Frequency Response.....	20Hz~20KHz
Operating Temperature	-20~+60°C
Dimensions	255mm(W)x250mm(D)x175.1mm(H)

TFT Display

TFT Screen size.....	10.6inch
Resolution.....	1024x600 pixels

FM Radio

Frequency Range (USA)	87.5~107.9MHz
Frequency Range (Europe)	87.5~108MHz
Usable Sensitivity (S/N=30dB).....	≤15dB
S/N Ratio.....	≥55dB
Stereo Separation.....	≥30dB

AM

Frequency Range (USA)	530~1710KHz
Frequency Range (Europe)	522~1620KHz
Usable Sensitivity(S/N=20dB).....	≤40dB
S/N Ratio.....	≥45dB

DVD/CD

S/N Ratio.....	≥60dB
Channel Separation	>50dB



Line-Out/Subwoofer Output

Maximum Output Level (10K ohms load).....	≥4Vrms
Subwoofer Time Align.....	0~18ms

15.AV IN

AV IN

The Audio/Video source with RCA cable can through the source unit to play the Audio/Video. Plug the RCA to the corresponding A/V socket.

Touch the  to pop up the function bars and touch  to view the playing Audio/Video.

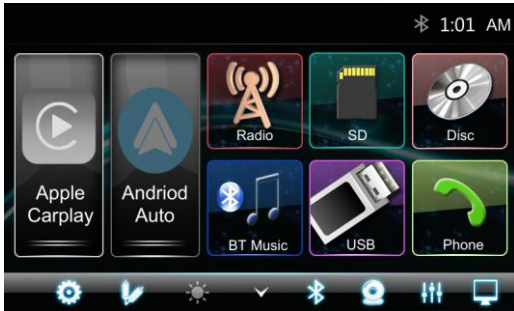

The Audi and Video will via the RCA cable to the source unit.



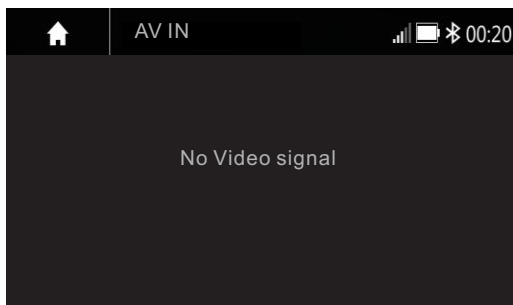

If there is no Video signal the below screen will be shown:



Camera

There is a RCA socket for the Front camera video signal to display on the Head unit. The Reverse wire in High level (+12V) is reverse; low level (ground or NC) is normal

16.Camera

Touch the  to pop up the function bars and touch  to view the playing Front camera.

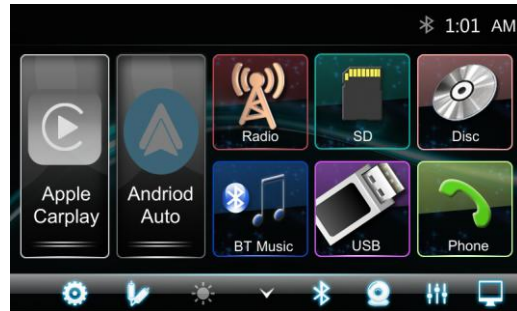



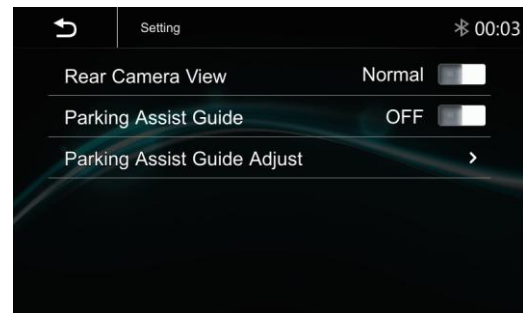

Rear Camera Setting:

Touch Rear View Camera in the Setting Menu to enter rear camera setting interface as follow:

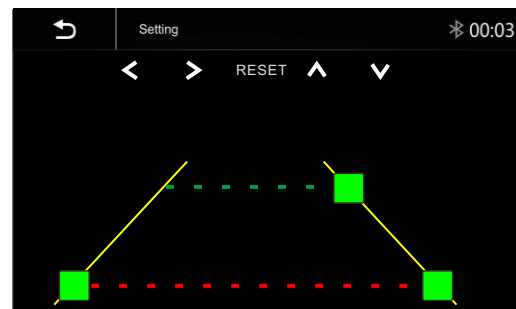

Rear Camera View: Normal/Reverse
Parking Assist Guide: On/Off
Parking Assist Guide Adjustment
Touch ">" to enter Parking Assist Guide Adjustment interface to show the below screen:



Select the adjust position and Touch  /  /  /  to adjust. Touch Reset to resume the default Parking Assist Line

WARNING! Changes or modifications to this unit not expressly approved by the party responsible for compliance could void the user's authority to operate the equipment. NOTE: This equipment has been tested and found to comply with the limits for a Class B digital device, pursuant to Part 15 of the FCC Rules. These limits are designed to provide reasonable protection against harmful interference in a residential installation.

This equipment generates, uses and can radiate radio frequency energy and, if not installed and used in accordance with the instructions, may cause harmful interference to radio communications.

However, there is no guarantee that interference will not occur in a particular installation. If this equipment does cause harmful interference to radio or television reception, which can be determined by turning the equipment off and on, the user is encouraged to try to correct the interference by one or more of the following measures:

- Reorient or relocate the receiving antenna.
- Increase the separation between the equipment and receiver.
- Connect the equipment into an outlet on a circuit different from that to which the receiver is connected.
- Consult the dealer or an experienced radio/ TV technician for help.