

STEALTH 10

CORE

**WIRED PASSIVE SOUNDBAR
USER MANUAL**



w e t s o u n d s

wetsounds.com



PASSION. PERFORMANCE. RUGGED FOR THE GREAT OUTDOORS!

Thank you for choosing Wet Sounds for your high performance Audio system! We build every product with Unsurpassed PASSION so we can deliver the HIGHEST PERFORMING Products to you! We live and breathe high performance audio. So you can enjoy the very best system options available for your vehicle.

The STEALTH Series Sound bars are designed to give every owner of a Boat, UTV, Golf Cart and virtually any vehicle the ability to add high performance Audio in a SIMPLE to use design. Made for the great outdoors the STEALTH Series Sound Bars are designed to be simple & easy audio options for your vehicle.

We appreciate your passion for great audio! Thank you for choosing Wet Sounds for your high performance audio needs.

www.wetsounds.com

Thank You.

For further questions, please call 1-877-938-7757 or check us out on the web.

STEALTH 6/10 CORE SOUND BAR SPECIFICATIONS

Easy mounting with multiple options

- Includes direct mounting bolts and L Brackets
- Optional Round & Square Pipe Mounting Brackets Available

Passive / Non Amplified Sound Bar

- 4 ohms per channel
- 75 watts RMS x 2 Minimum
- 100 watts RMS x 2 Suggested (STEALTH 6 CORE)
- 150 Watts RMS x 2 Suggested (STEALTH 10 CORE)
- 14 Gauge OFC Copper Speaker Wire Recommended
- Weight - 19 lbs

Recommended Wet Sounds Amps

- STEALTH 6 CORE – SYN Micro or HT 4 (on 2 channels)
- STEALTH 10 CORE – HT-2
- Recommended Amplifier crossover settings – High pass @ 100Hz

Other recommendations

- Loc-tite all hardware to prevent loosening of bolts
- Use protective wire loom on all wiring to prevent shorts

STEALTH 10 CORE SOUND BAR SPECIFICATIONS

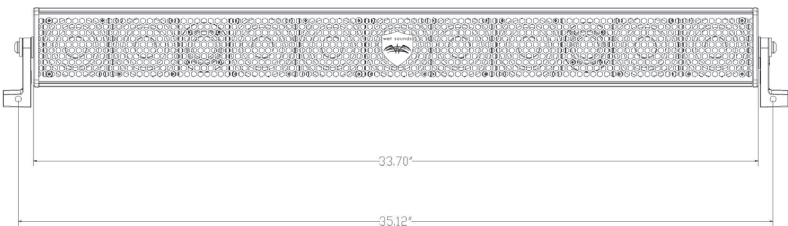
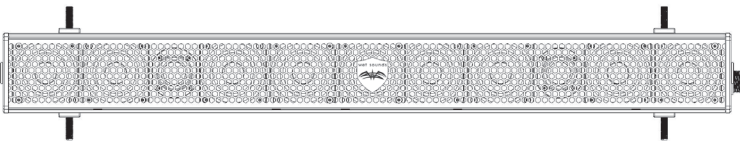
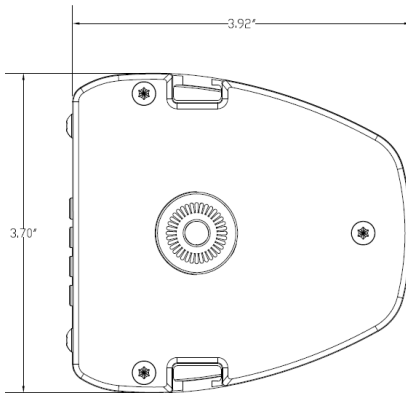
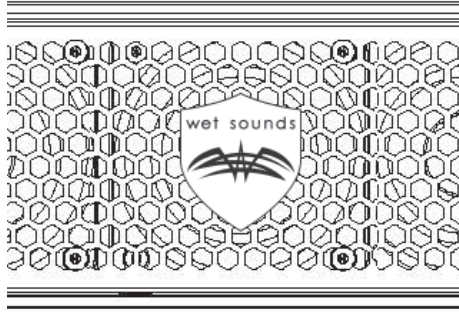

INSTALLATION

3.

A. Instructions

1. Fit the appropriate tube clamp around the front strut in the desired location.
***Note: you may need to remove bolts connecting the top to the front strut to complete this step.**
2. If a sliding adapter was supplied in your kit, you will need to loosely fasten it to the soundbar, and then to the round tube clamps installed in step 1.
3. Ensure that the sound bar is in the desired location, then tighten all hardware.

B. Wiring

STEALTH 10 & 6 CORE Sound Bars are designed to be connected to a source unit or amplifier.

1. Mount & wire the power amp/source unit according to the manufacturer's specifications.
2. Run the appropriate sized speaker wire (suggested minimum 18 Gauge) to the sound bar.

Wiring Color Codes for both units are as follows:

Red w/ White Stripe:	Right + (positive) Speaker Connection
Black w/ White Stripe:	Right – (negative) Speaker Connection
Solid Red:	Left + (positive) Speaker Connection
Solid Black:	Left – (negative) Speaker Connection

3. Tie up all excess wires.

LIMITED WARRANTY

How to Obtain Warranty Service

Contact Wet Sounds, Inc. either by phone at 877-938-7757 or by email at warranty@wetsounds.com. A service representative will assist you in the necessary actions to verify that the problem that you are experiencing is covered under warranty. If it is in fact a warranty issue, Wet Sounds will issue an RA number for tracking purposes and give instructions on sending the product in for evaluation. Wet Sounds™, Inc. How State Law Applies This warranty gives you specific legal rights, and you may also have other rights which vary from state to state.

Internet Warning

Wet Sounds, Inc. products sold on any non authorized web site or internet auction site are void of any and all manufacturer's warranty. Please contact Wet Sounds™ at 877-938- 7757 or visit our web site at www.wetsounds.com to search for an authorized site and/or an authorized retailer near you.

Caution & Respect

Wet Sounds™ speakers can achieve very high sound pressure levels. Please use this product responsibly. Be aware that sound travels great distances so please respect others. Wet Sounds, Inc. is not responsible for any violations of the law that may be a direct result of excessive volume. Please abide by the rules but have fun doing it.

LIMITED WARRANTY

What This Warranty Covers

This is a “Limited” warranty. This warranty covers any defects in materials and workmanship and warranty only applies to the original purchaser and is not transferable. This warranty is also only valid if the original purchase was made from an authorized Wet Sounds™ dealer.

How Long Coverage Lasts

This warranty runs for one year from the date of the purchase.

It is recommended to REGISTER your warranty online within 45 days of your purchase at www.wetsounds.com – click on “warranty registration”.

What Is Not Covered

This warranty does not cover fading or discoloration caused by exposure to sunlight or chemicals such as ammonia, household bleach, or any cleaning material that contains abrasive substances. (For information on how to prevent fading or discoloration, consult for recommendations on cleaning products) Wet Sounds, Inc. does not cover the cost for removal and reinstallation of any kind. Additionally, shipping TO Wet Sounds, Inc. is covered by the purchaser This warranty is void and inapplicable if Wet Sounds™ deems that the product was abused or misused; including but not limited to Speaker product that has been improperly-powered (under or over powered), causing thermal (burnt voice coil) and/or mechanical failure (torn surrounds or spiders), damage caused by accident, mishandling, improper installation, negligence, normal wear and tear, excessive water or heat damage, freight damage or products that have been altered in any way. Product owned by anyone other than the original purchaser from an authorized Wet Sounds dealer. (The warranty is not transferable and will not apply to products purchased from unauthorized dealers.) Wet Sounds is not responsible for any damages to a consumer’s boat or person from a product failure. The warranty is void if Wet Sounds deems the product was installed or used improperly. Wet Sounds shall not be responsible for any incidental or consequential damages, except to the extent provided (or prohibited) by applicable law. This warranty gives you specific legal rights, and you may also have other rights which vary from state.

What Wet Sounds™, Inc. Will Do

Wet Sounds, Inc will repair any part of your product that proves to be defective in materials or workmanship. In the event repair is not possible, Wet Sounds, Inc will replace the product in question. If it is deemed necessary Wet Sounds, Inc. will either replace the entire product with a refurbished unit or it will be replaced with a model that is similar in price if that model is no longer available. Labor cost and materials needed to complete this service will be at no charge to the purchaser. Additionally, the cost of shipping TO the consumer is also covered under this warranty.

Optional Accessories

Please visit www.wetsounds.com for more information

Stealth Clamp Square 1.25" (ST-ADP-SQ 1.25)

1.48" (L) x 0.79" (W) x 2.17" (H)

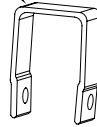

1.26" (W) x 1.26" (H)

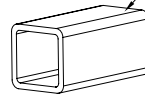

Stealth Clamp Square 1.0" (ST-ADP-SQ 1.0)

1.61" (L) x 0.79" (W) x 1.90" (H)

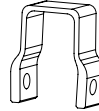

1.0" (W) x 1.0" (H)

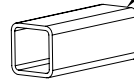

Stealth Clamp Square .75" (ST-ADP-SQ .75)

1.41" (L) x 0.79" (W) x 1.56" (H)



0.75" (W) x 0.75" (H)

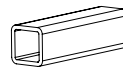

1.99" (L) x 0.79" (W) x 2.62" (H)

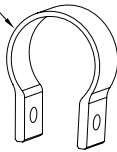

Ø1.75"

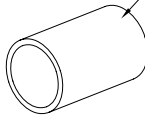

Stealth Clamp Round 1.75" (ST-ADP-SQ 1.75)

1.71" (L) x 0.79" (W) x 2.36" (H)

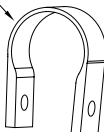

Ø1.50"

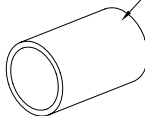

Stealth Clamp Round 1.5" (ST-ADP-SQ 1.5)

Stealth Adapter Slide Bracket (ST-ADP-SLIDE BRACKET)

2.48" (L) x 1.06" (W) x 1.36" (H)

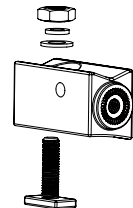
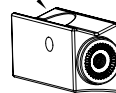



Wet Sounds Inc..
www.wetsounds.com
877-938-7757

10621 S Sam Houston Pkwy W. Suite 100
Houston, TX 77071 - USA

