

AudioControl®

Making Good Sound Great™

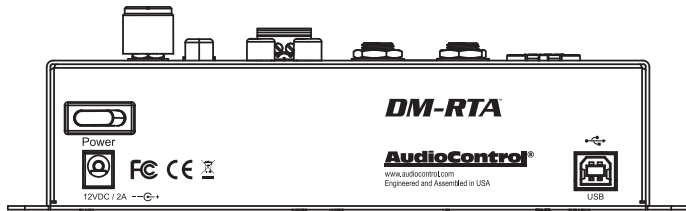
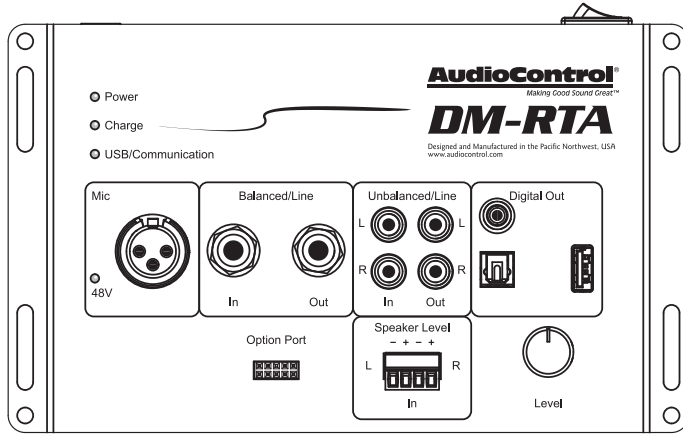

DM-RTA™

Most Excellent
Real Time Analyser

Operation Manual

Important Safety Instructions

1. Read these instructions.
2. Keep these instructions.
3. Heed all warnings.
4. Follow all instructions.
5. Do not use this apparatus near water.
6. Clean only with a dry cloth.
7. Install in accordance with the manufacturer's instructions.
8. Do not install near any heat sources such as radiators, ovens, furnaces or other apparatus (including amplifiers) that produce heat.
9. **WARNING:** Improper operation may lead to permanent injury or death..
10. Use only the power adapter supplied by the manufacturer to power this apparatus.
11. This device uses internal rechargeable batteries. Do not leave the device unattended while charging.
12. Only use attachments/accessories specified by the manufacturer.
13. Refer all servicing to qualified service personnel. Servicing is required when the apparatus has been damaged in any way, such as the power input terminals are damaged, liquid has been spilled or objects have fallen into the apparatus, the apparatus has been exposed to rain or moisture, does not operate normally, or has been dropped.

14. This apparatus shall not be exposed to dripping or splashing, and no object filled with liquids, shall be placed on the apparatus.
15. Fuses shall be replaced only with the correct type and fuse value, and only when the apparatus is powered off.
16. Exposure to high sound pressure levels may lead to permanent hearing loss. Take every precaution to protect your hearing.



The lightning flash with arrowhead symbol within an equilateral triangle is intended to alert the user to the presence of uninsulated "dangerous voltage" within the product's enclosure, that may be of sufficient magnitude to constitute a risk of electric shock to persons.



The exclamation point within an equilateral triangle is intended to alert the user of the presence of important operating and maintenance (servicing) instructions in the literature accompanying the appliance.

Caution: to reduce the risk of electric shock, do not disassemble the apparatus. There are no user-serviceable parts inside. Refer servicing to qualified personnel.



Recycling notice: If the time comes and this apparatus has fulfilled its destiny, do not throw it out into the trash. It has to be carefully recycled for the good of mankind, by a facility specially equipped for the safe recycling of electronic apparatus. Please contact your local or state recycling leaders for assistance in locating a suitable nearby recycling facility. Or, contact us and we might be able to repair it for you.

Table of Contents

Important Safety Instructions	2
Chapter 1: Introduction.....	4
Chapter 2: Quick Start	5
Chapter 3: Hookup Diagrams	7
Chapter 4: Installation	13
Chapter 5: Features	14
Chapter 6: Installing the Application	17
Chapter 7: Microphone Options	20
Chapter 8: The Display	21
Chapter 9: Specifications	35
Chapter 10: Service	37
Chapter 11: The Warranty	38
Let's Dance!	40

Congratulations on the purchase of a fine AudioControl product. You have chosen wisely. We hope that it will give you many years of super audio enjoyment and larks.

When you require total control and optimization to achieve great sound quality, AudioControl's DM-RTA real time analyzer will help you measure, understand, and adjust your system to perfection.

Connect your laptop using our smart user RTA Interface, which is designed to give you instant and clear control over every aspect of your system measurement and evaluation.

Please visit our new, bold, and elegantly-lovely knowledge base at: www.audiocontrol.com/knowledge-base for all manner of helpful audio tips and wisdom gathered from the collective noodles of our technical support engineers and audio chaps.

Here are some of the features of this fine bit of audio kit. It is so really-fine, that you may wonder how you ever got by without it.

Inputs and Outputs:

- XLR input with 48V phantom power
- Balanced input and output TRS ¼" jacks
- Stereo RCA inputs and stereo outputs
- Digital Coaxial stereo output
- Digital Optical stereo output
- USB stereo output
- Speaker-level input
- Option Port

Hardware Main Features:

- Tone generator – with sine wave, pink noise and square wave test tones
- Easy test tone frequency control via the encoder knob – press to increment octaves, and rotate to control the level
- Battery powered – it will last a good 4 hours and probably longer. Plug it into power and the battery will charge too!
- Option port – get the AC-BT24 and download the DM-RTA app and have all your control and testing right there on your phone or tablet

Here are some of the things that the DM-RTA hardware and software will allow you to do:

- RTA 1/3, 1/6, and 1/12th octave views
- Polarity checker – with a mic, speaker level or line level signal
- Voltage meter – just run a signal in with a sine wave and check your sources or processor's output signal voltage
- Generate test tones – sine, noise, click track for polarity etc.
- Oscilloscope to check for clipping!
- Monitor your input
- Bulletproof 5 year warranty (when purchased from an authorized AudioControl dealer)
- Engineered, designed, and manufactured in our leafy, shaded and secluded audio-goodness technodrome in beautiful Mountlake Terrace, WA.

Quick View

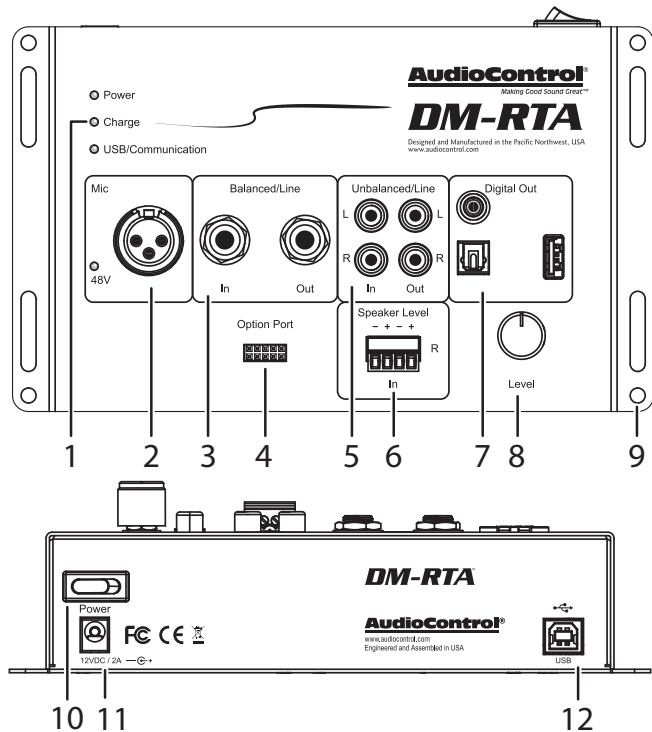

1. LEDs for Power, Charge, and USB activity
2. XLR Microphone input with 48V LED
3. 1/4" TRS Balanced Line-Level Input and Output
4. Option Port for optional accessory
5. RCA Unbalanced Line-Level Inputs and Outputs
6. Stereo Speaker-Level Inputs
7. Coaxial, Optical, and USB Digital Outputs
8. Rotary Push-Encoder for Test-Tone Frequency Control
9. Mounting Holes
10. Power On/Off switch
11. +12V Power Input Connector
12. USB Type B Connector

(Nine out of ten users could not tell the difference between the DM-RTA and real butter)

Quick Start

Before you start, please take a moment to visit our knowledge base: www.audiocontrol.com/knowledge-base. It will help you with a plethora of sound advice, and help set the mood.

1. The following details give a brief overview of the steps required to use the DM-RTA in your system. The steps below are explained in more detail throughout this manual, with a few handy connection diagrams.
- ** **Important Note:** The DM-RTA is a mono device. Stereo inputs sum together, and the various signal input types all connect to a summing bus as well. Use one input or just the left or right of the stereo signal to accurately analyze the signal.
2. Plan how you are going to use the DM-RTA to measure your audio system. For example, will it receive the audio from your system through the line-level RCA or 1/4" TRS, the speaker-level inputs, the option port, or will you use a measurement microphone?
3. When making connections, designate red RCA plugs as right, and designate white, black, or grey plugs as left.
3. Connect your audio inputs to the unit – either speaker-level, line-level RCA, line-level 1/4" TRS, or XLR microphone.
4. When you are satisfied that all the connections are looking good and correct, connect the supplied power adapter. Make sure the DM-RTA is off.
5. Install the control application onto your computer, but make sure that the computer is not connected to the unit during the installation.
6. Connect the computer to the unit using the rear panel USB connection.
7. Turn on power to the DM-RTA.
8. Run the application. The unit will be recognized.
9. Use the application to measure every aspect of your system, and adjust the system as required, until you have it sounding just right.
10. The DM-RTA can send test tones into your system.
11. If you are using the microphone, make sure it is securely mounted when taking measurements. Some microphones require Phantom Power, so we have included a +48V button in the user interface to enable/disable Phantom Power.
12. When you are happy with your measurements and the system, turn off all power to the system before removing all the cables and connections to the DM-RTA.
13. Store the DM-RTA in a safe place, dry and cozy. Keep good quality cables just for use during measurements.
14. Check our website regularly for any updates to the DM-RTA application and firmware.

Power Connections

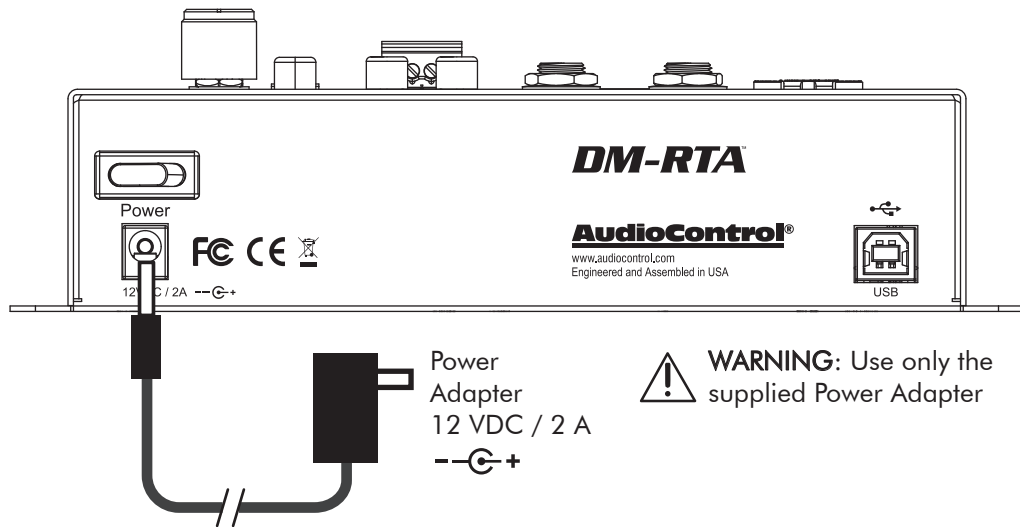

Computer Connection

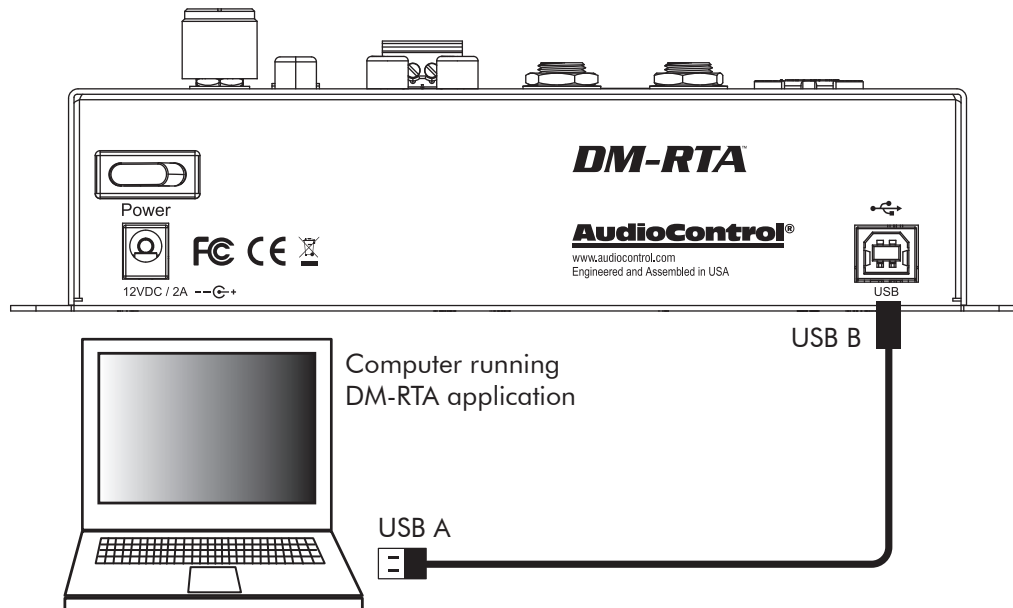

System #1: Using the microphone input

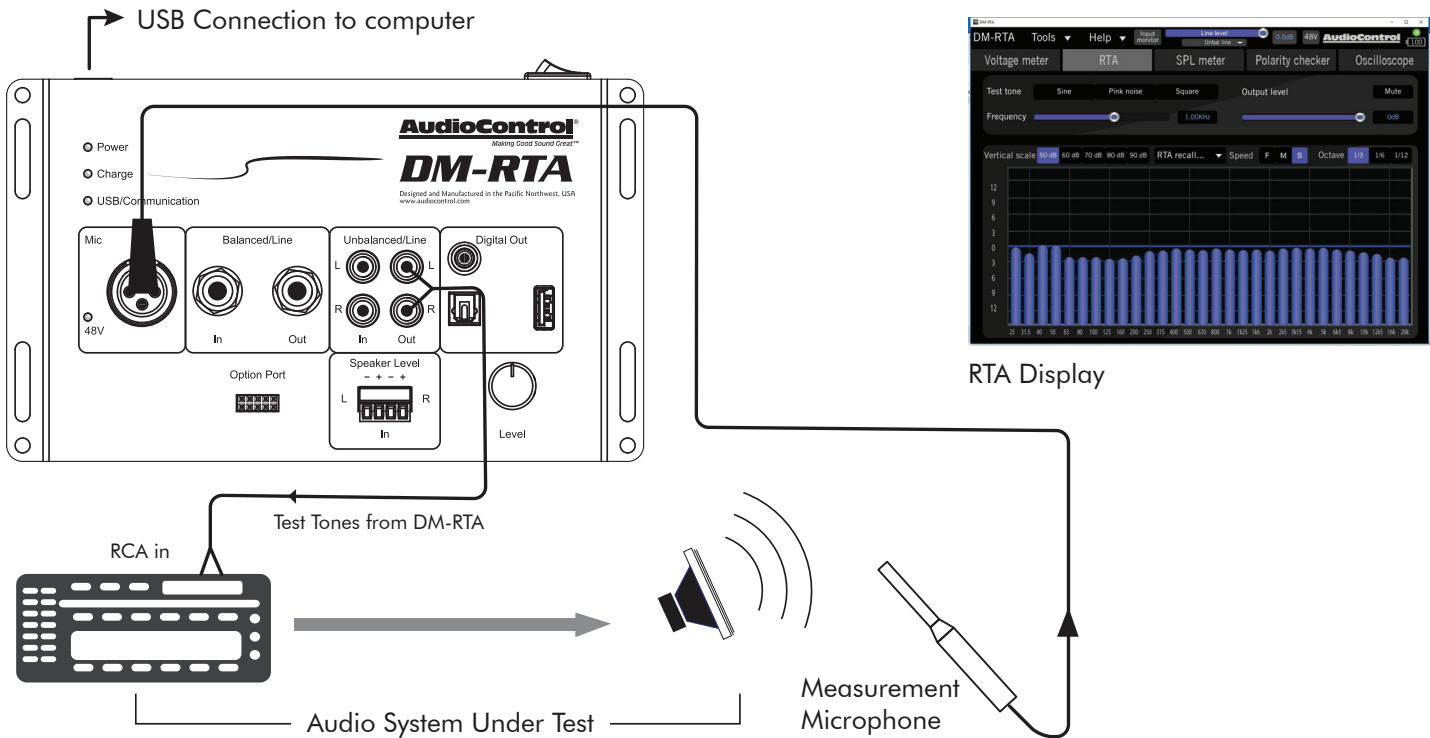

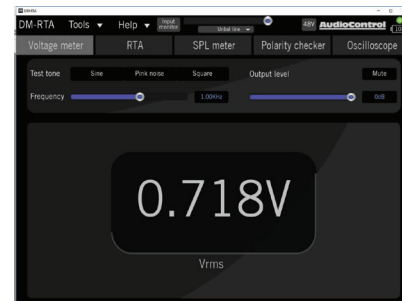
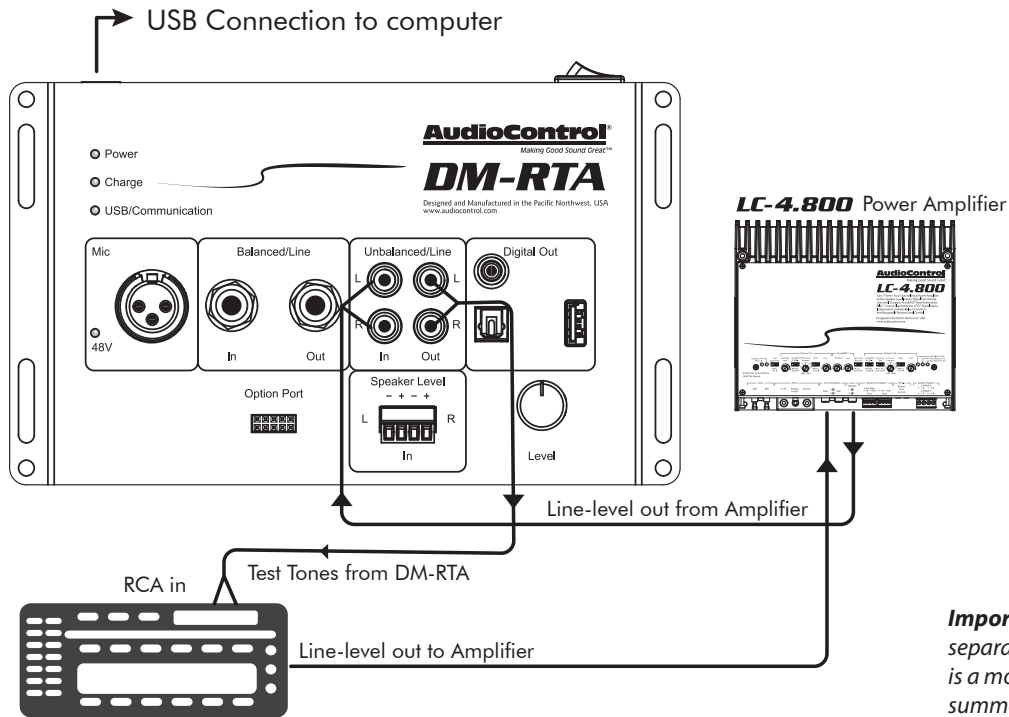
System #2: Using the line-level RCA inputs

Voltage Meter Display

Important Note: Test the Left and Right signals separately to measure discrete results. (The DM-RTA is a mono device and the stereo input signals are summed.)

System #2: Using the line-level 1/4" TRS inputs

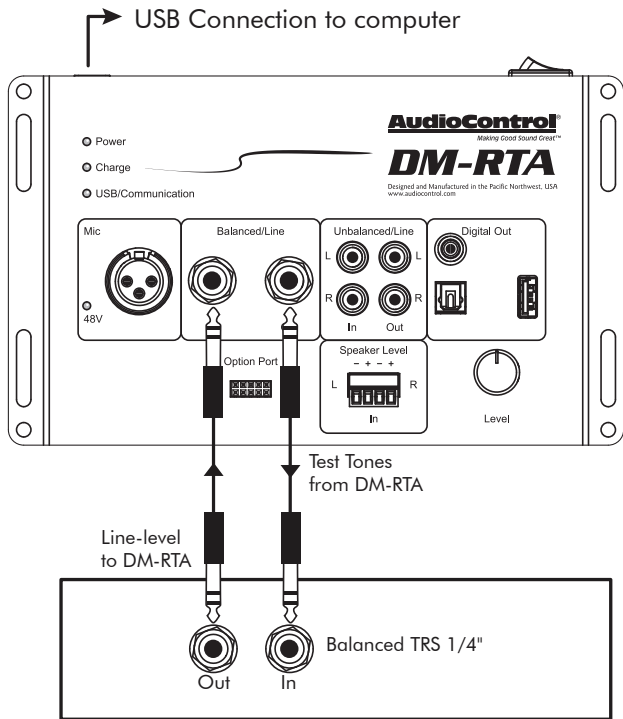

Oscilloscope Display

Audio device, such as mixer, preamplifier, synthesizer

System #3: Using the speaker-level Inputs

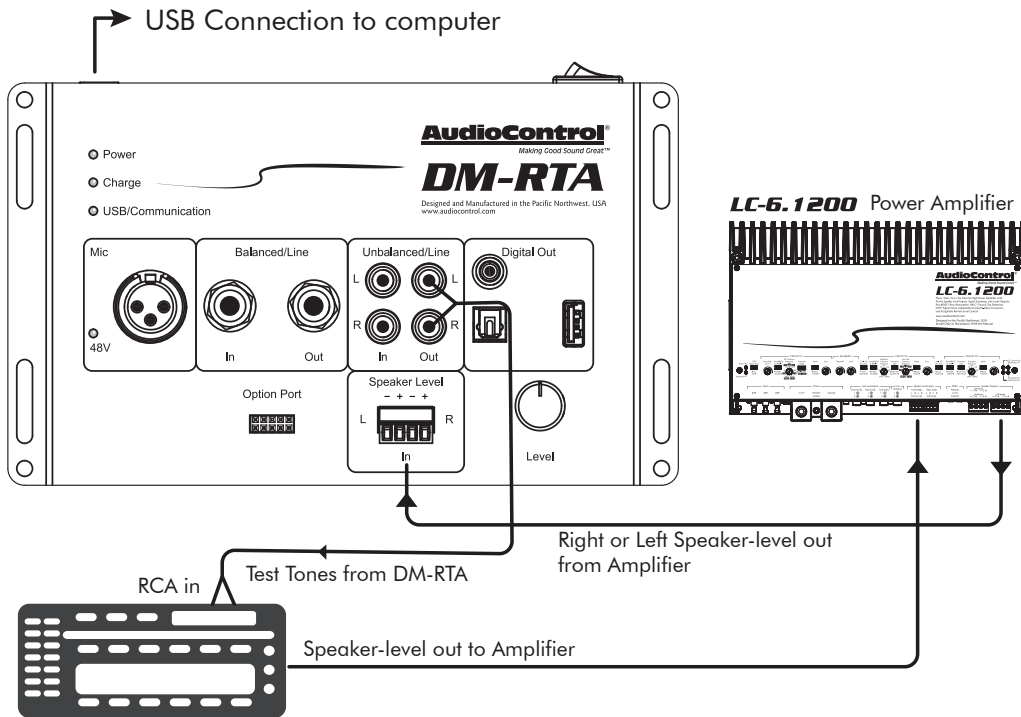

Installation

The DM-RTA has mounting holes that allow you to install the unit in a test rig, such as a mobile cart. These holes have been specially imported and flown in from Blackburn, Lancashire. If you are not going to install the DM-RTA, you can still keep the holes.

When choosing a location, please keep these things in mind:

1. Before you start, disconnect all cables to and from the DM-RTA to prevent any damage during the installation process.
2. Pick a mounting location that will provide access to the controls and connections, provide adequate ventilation, and also protect the unit from heat, moisture, dirt, sticky toffee, and crayons.
3. The DM-RTA needs to be securely mounted using the mounting holes located in each corner.
4. Before drilling any holes into the mounting surface, take every precaution to prevent damage to fuel lines, power and other electrical wiring, hydraulic brake lines, sewer systems, AC plumbing, and hot and cold water lines that might compromise safety.
5. Use good quality connection cables between the DM-RTA and the system under test. Any cables with a dodgy ground connection can cause all sorts of problems with your measurements.
6. The DM-RTA also has speaker-level inputs that are designed to accept amplified, speaker-level signals from a factory source unit or amplifier. You may need to refer to a factory service manual or wiring-harness schematic to determine which wires are the speaker wires for your system. If you are unsure which are the speaker wires, we recommend you look at the color of the speaker wires connected to the speakers and follow them back to the source. Connect the speaker wires to the DM-RTA speaker-level input plugs using the correct polarity.
7. Line-level audio signals will generally come from your aftermarket radio. The DM-RTA produces Test Tones that feed back into your system. There are generally only two things to consider when using the line-level connections: 1. Use good shielded or twisted pair RCA cables and 2. Run your RCA cables at least 18" away from power and speaker cables to avoid picking up radiated noise in your system.

Features

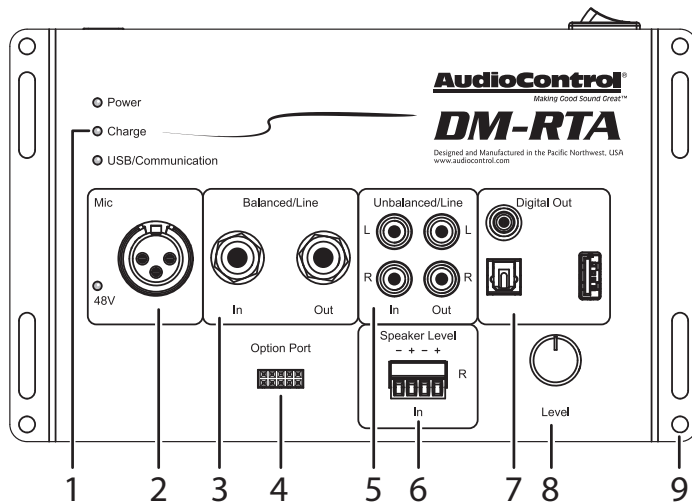

1. Power LED – This indicates when the DM-RTA Power switch is turned on. The DM-RTA can be powered by the supplied power adapter, or it can run for up to 4 hours on its internal rechargeable battery.

Charge LED – This indicates when the internal rechargeable battery is being charged.

USB Activity LED – This indicates when there is USB activity between the DM-RTA and your computer.

2. XLR Microphone Input – This XLR input is used to connect a measurement microphone to the DM-RTA. Some microphones require 48V Phantom Power, and this can be engaged using the DM-RTA software interface, and the 48V LED will turn on as a warning.

CAUTION: Some microphones can be damaged by Phantom Power, so make sure you read your microphone's manual before engaging. (Reading owner's manuals is an OK thing to admit.)

- 3. 1/4" TRS Line-Level Input and Output** – These are balanced connections for line-level analog signals. The line-level 1/4" TRS output from your equipment can connect here, so the DM-RTA will receive the line-level audio signals for analysis. The line-level analog output from the DM-RTA connects to the line-level inputs of your power amplifiers and other equipment.
- 4. Options Port** – This port allows you to connect our optional Bluetooth adapter, so you can stream audio into the DM-RTA from your Bluetooth-enabled devices. Further details will be available when this accessory and others become available.
- 5. RCA Line-Level Inputs and Outputs** – These are unbalanced stereo RCA connections for line-level analog signals. The line-level output from the head unit or factory-installed radios can connect here, so the DM-RTA will receive the line-level audio signals for analysis. The line-level analog outputs from the DM-RTA connect to the line-level inputs of your power amplifiers and other equipment.
- 6. Stereo Speaker-Level Inputs** – The speaker-level output from amplifiers and factory installed radios can connect here, so the DM-RTA will receive the audio signals this way and do its thing. Make sure that you follow the plus and minus polarity markings on the DM-RTA and match it to the polarity of the speaker wiring. Analog signals entering the DM-RTA are the sum of the speaker-level inputs and the other inputs.
- 7. Coaxial and Optical Digital and USB Outputs** – These S/PDIF and Toslink inputs allow you to connect the digital audio output from the DM-RTA to your other equipment.
- 8. Rotary Push-Encoder** – This control is used to adjust the Test Tones from the DM-RTA. Press the control to increment through octaves, and rotate it to control the level.
- 9. Mounting Holes** – These holes are used for mounting the DM-RTA securely, if for example, you want to install it as part of handy test cart.

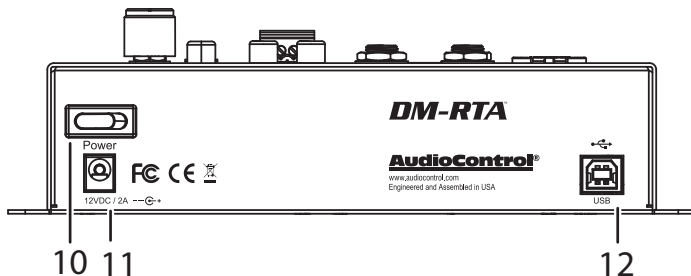

- 10. Power Switch** – Press this momentary switch to turn on power to the DM-RTA. If the supplied power adapter is connected to live AC mains power, then the adapter will supply power to the DM-RTA and recharge its internal battery. If the power adapter is not used, then the power switch will still turn on the DM-RTA and it will run on internal battery power, for approximately 4 hours or more.
- 11. DC Power Input** – Connect this input to the +12 VDC output connector of the supplied power adapter. Use only the supplied power adapter. (It is a high-current model designed to operate the DM-RTA and to charge the internal batteries.)
- 12. USB Connector** – This USB Type B connector connects to the USB Type A port of your computer in order to use the control software of the DM-RTA.

Installing the Application

1. Before you begin, make sure that you are wearing sturdy corduroy trousers and sensible shoes.



Make sure that the DM-RTA is not connected to your computer during the installation of the application

3. Visit our super spiffy website at www.audiocontrol.com and locate the application on the DM-RTA product page. Download it onto your computer. It is available as a zipped file containing the .exe file and a bin file. Un-zip the file and select and open the version that is compatible with your computer.
4. When running for the first time, the application will automatically search for the required drivers, and this may take some time, depending on your system. Do not be alarmed, as it will turn out well, and we will all laugh about this one day.

5. Select the installation folder, or select the default location. Click “Next”

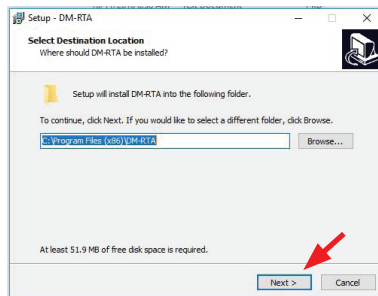

6. Select the Start Menu Folder or Browse, click “Next” to confirm.

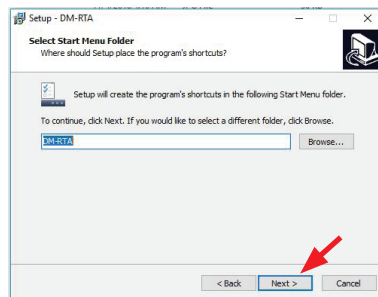

Chapter 6: Installing the Application

- Other impertinent screens appear. Click “Next” to confirm, “Install” and click on “Finish” once the installation is complete. Hurrah!

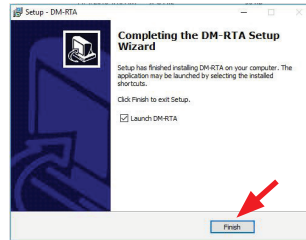
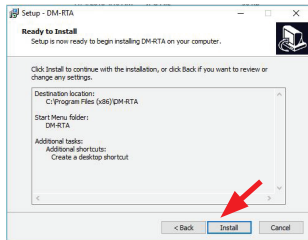
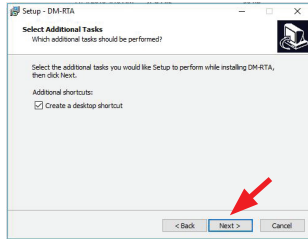

- The new application “DM-RTA” will now appear on your computer.

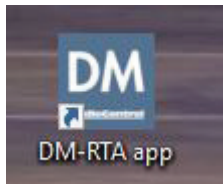

- Open the DM-RTA application and the main GUI (graphic user interface) will appear as if by magic.

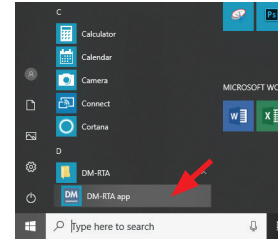

- Now that the application and drivers are all installed and ready to go, it is time to connect to the DM-RTA unit as follows:
 - Connect the USB Type B end of the supplied USB cord into the DM-RTA unit, and the USB A type end into a spare USB port on your computer.
 - Turn on the DM-RTA using the rear panel power switch.
 - The DM-RTA Power LED should turn on, and the still-running application (see step 10) should now recognize the DM-RTA.
 - The application and the unit are now connected and talking to each other nicely, like old friends.
 - Put the kettle on, it's time for tea.

Here are a few notes in case you run into any problems with the installation.

1. If there is a previous version of the application installed, then this has to be un-installed before installing the new version.
2. Sometimes during the installation, you may run into odd things, depending upon how Windows is feeling. Usually you can ignore these warnings, as the files supplied by us are trusted, tested, and kind to pets and children.

Due to our bold and never-ending quest for audio righteousness, it is quite likely that the firmware will be updated at some time. This is the infernal firmware running within the DM-RTA, and differs from the software application running on your computer.

1. To obtain the new firmware, visit our website at www.audiocontrol.com and locate the firmware/application on the DM-RTA product page. Download it onto your computer. It is available as a zipped file containing a firmware “bin” file. Un-zip the file on your computer, and note its location.
2. Compare the file’s version number with the version shown on the software application (Help menu/About), and if the downloaded file is newer, then a firmware update is recommended.
3. To update the firmware, first run the software application, turn on the DM-RTA unit, and wait for it to finish its deliberations. Then select Tools > Update device firmware
4. After a warning, browse to find the location of the new firmware BIN file to be uploaded onto the DM-RTA.
5. The firmware installation will begin.
6. And end.
7. After the firmware has been successfully updated, the software application will reboot the unit and the new firmware will be in play. Welcome to a brave new world of audio goodness.

Microphone Options

AudioControl offers a wide range of professional measurement and instrumentation microphones which will make a perfect addition to your DM-RTA tool kit, and allow you to make accurate acoustical measurements.

CM-20



For an entry-level measurement microphone, choose the CM-20.

CM-10



Use the CM-10 if you want to use the long time standard issue microphone for AudioControl's legendary SA-3052 analyzers.

C-550h



The high-precision Josephson C-550h rounds off the top of the list for truly accurate readings and impeccable frequency response.

The Display

The display has five main sections, one for each of the main audio tools of the DM-RTA. Each display will be discussed in the following pages.

Voltage Meter

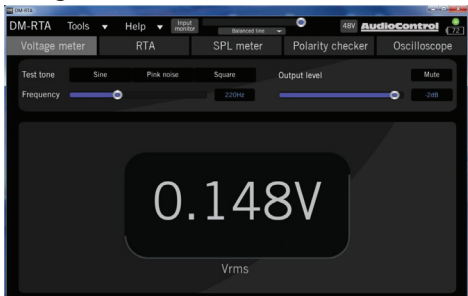

Real Time Analyser



SPL Meter

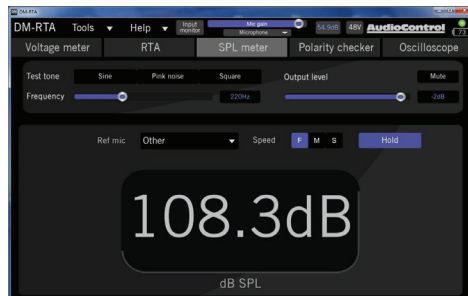

Polarity Checker

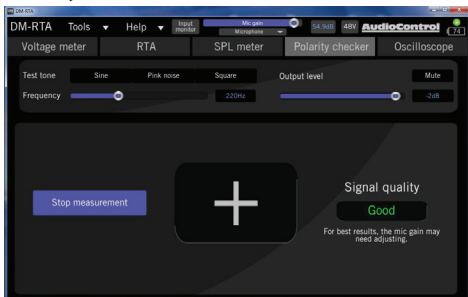

Oscilloscope



The Top Line Controls

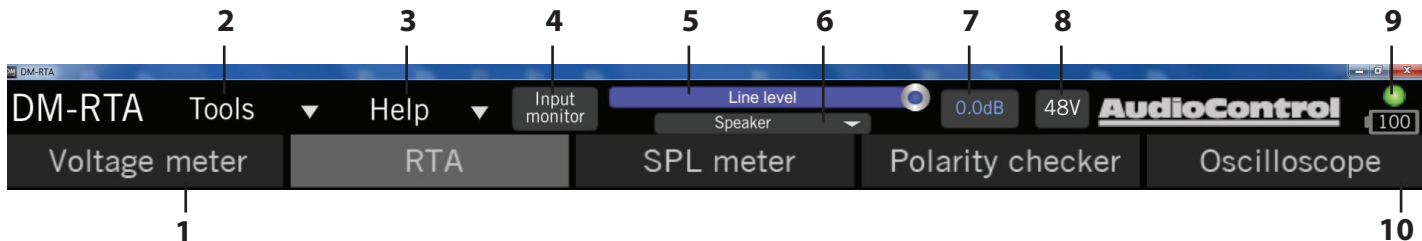

1. Large Tabs – These tabs allow easy access to the five main tools.

2. Tools Menu – This has a drop-down menu with 3 options:

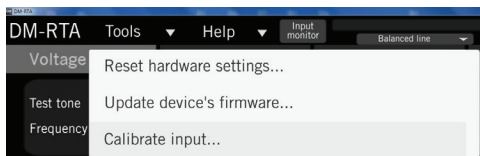

Reset hardware settings – Select this to reset the hardware settings back to as they were from the factory.

Update device's firmware – Select this if there is a newer version of the firmware available.

Calibrate input – This option is only available in the Voltage meter operation, and it is described later.

3. Help – This has a drop-down menu with 3 options:

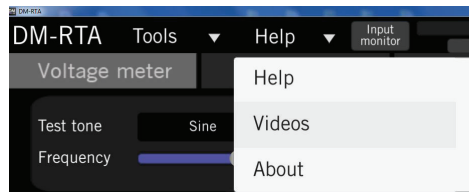

Help – Select this to open up a PDF copy of this very manual.

Videos – Select this to open up AudioControl's collection of adorable cat videos.

About – Select this to show the software and firmware version currently running.

- 4. Input monitor** – Select this to monitor the signals coming in to the DM-RTA unit. This will loop out the incoming signal or test tone if that is what you are using – if there is an RCA input that you are looking at on the RTA, you can still have the audio running through the intended signal path. This should operate like a tape loop monitor from those sunny audio days when we were young.
- 5. Input level** – This allows you to adjust the input level used in the RTA, SPL, and Polarity Checker tools. Move the sliding ball left (to increase) or right (to decrease). The setting can be different for each of the DM-RTA tools.
- 6. Selected input** – This does not select the input, but it sets the gain to an appropriate level for the input you are using. So if you are using the microphone input, select this here. The setting can be different for each of the DM-RTA tools.
- 7. Gain dB** – This numerical value can be changed by using the mouse and entering a new value using your computer keyboard. It gives some fine control compared to just dragging the input level control (5).
- 8. 48V** – Select this only if you are using a microphone that requires 48V Phantom Power. Note that some microphones can be damaged by using Phantom Power, so make sure you really need it, before selecting this button.
- 9. Green light of goodness** – This green light will appear if the DM-RTA device has been recognized by the DM-RTA software application.
- 10. Battery Charge** – This percentage value indicates how much the internal battery is charged. The device will automatically charge if it is connected to the supplied power supply adapter. The Charge LED on the device will light when it is charging. Use only the supplied power supply adapter. There are approximately five hours of play time from a fully charged device before it needs to be recharged.
Warning: Do not leave the device unattended while charging.

The Test Tone Controls

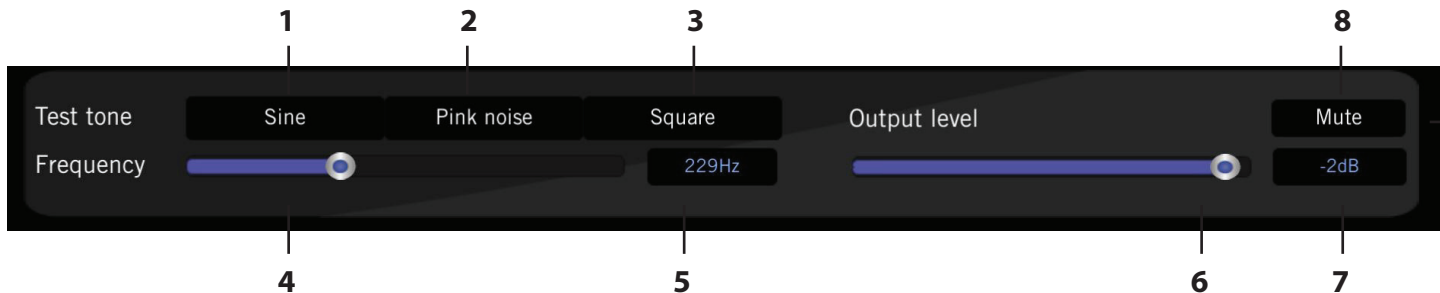

1. **Sine** – Select here to turn on a pure sine wave test tone.
2. **Pink Noise** – Select here to turn on a pink noise test signal.
3. **Square** – Select here to turn on a square wave test tone.
Caution: Take care with the use of test tones in case the amplifiers in your system take offence and overheat, or this causes damage to your hearing. Amplifiers (and ears) are much more used to the normal ups and downs of musical program material, than the constant sine wave test tones, especially at the lower frequencies.
4. **Frequency** – The sine wave or square wave test tone frequency can be changed by dragging this control left or right.

If you press and hold the round encoder knob on the actual DM-RTA device, the frequency will increase in Octave steps.

5. **Frequency Value** – Alternatively, you can adjust the sine wave or square wave frequency by entering a numeric value here.
6. **Output Level** – You can adjust the output level of the test tone by dragging this control left or right.
You can also adjust the output level by rotating the round encoder knob on the actual DM-RTA device.
7. **Output Level Value** – Alternatively, you can adjust the test tone output level by entering a numeric value here.
8. **Output Level Mute** – You can quickly turn the test tone output on and off by clicking here, without changing the level value.

Voltage Meter

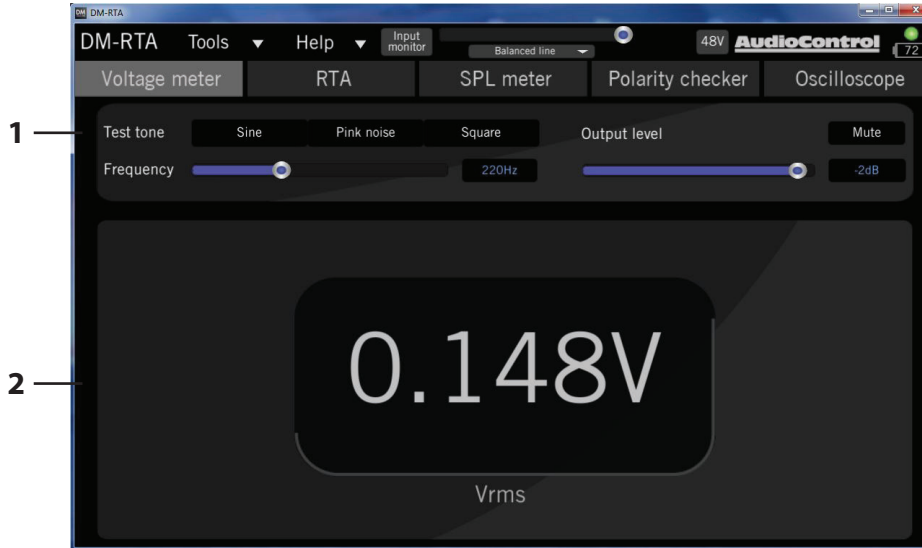

The voltage meter will give an accurate reading of the AC Voltage (rms) of sine wave audio signals entering the DM-RTA.

Note: The incoming audio signal must be a pure sine wave, and only one input must be connected at a time. The source can either be a sine wave test tone generated by the DM-RTA, a test tone CD or MP3 file playing from a source, or an external audio generator.

Chapter 8: The Display: Voltage Meter

- 1. Test Tone** – Select the test tone to be a sine wave if you want to take voltage measurements using the internal test tones. Connect the DM-RTA output so that the test tone will play in your system.
- 2. Voltage display** – This large meter displays the rms voltage of the incoming sine wave.

Calibration

The voltage meter can be calibrated using the calibration menu available under the Tools menu. (Only the voltage meter has this option.)

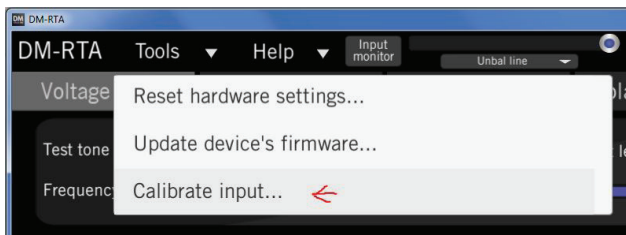

This calibration routine allows you to enter a sine wave of known voltage. The DM-RTA will measure this reference signal and adjust the displayed reading to be exactly the voltage you entered.

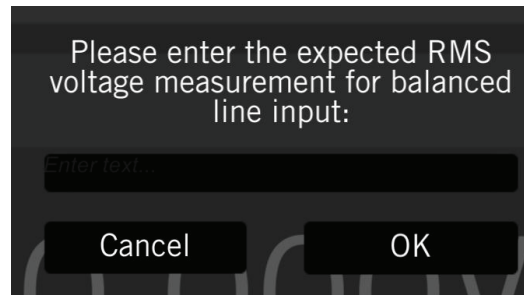

Real Time Analyser



The RTA display allows you to see the response of your system, and see how the levels vary across the audio range of frequencies. You can investigate any gaps in the response, adjust crossover controls (if your system allows such niceties) and adjust any EQ controls you might have.

The display shows the frequency along the horizontal axis, and the signal level along the vertical axis. As an example, if you were playing a sine-wave test tone, it would appear in the RTA as a peak centered around the test tone frequency. If you vary the test tone output level, then you will see the displayed signal increase or decrease in level. If you adjust the test frequency, then you will see the peak move left or right in the display.

If you play a square wave test tone, then you will see the fundamental peak at one frequency, in addition to multiple smaller peaks at higher frequencies. (A square wave is made up from a series of sine waves in combination.)

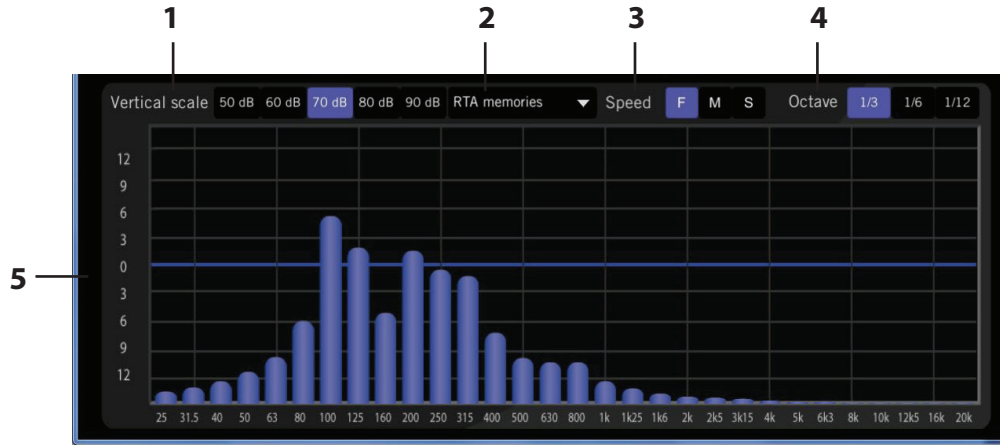

- 1. Vertical Scale** – These options allow you to select the vertical scale of the RTA from an overall signal range of 50 dB, 60 dB, 70 dB, 80 dB, and 90 dB.
- 2. RTA Memories** – Up to six RTA displays can be stored and recalled using the drop-down menu available here. These allow you to save those precious memories for safe keeping, showing them to your friends, and recalling the way things were. All the Memories can be cleared, and also the average of all memories can be displayed.
- 3. Speed** – Choose the display speed from Fast (F), Medium (M), and Slow (S). Note that the low frequencies always have a slower settling time than the higher frequencies.
- 4. Octave** – Choose the octave range between readings, from 1/3rd, 1/6th, or 1/12th octave. For example, if you select 1/3, there will be three readings per octave (three vertical bars). For more detail, select 1/6 or 1/12 (six or twelve readings per octave)
- 5. RTA Display** – The display shows the frequency along the horizontal axis, and the signal level along the vertical axis.

Sound Pressure Level Meter

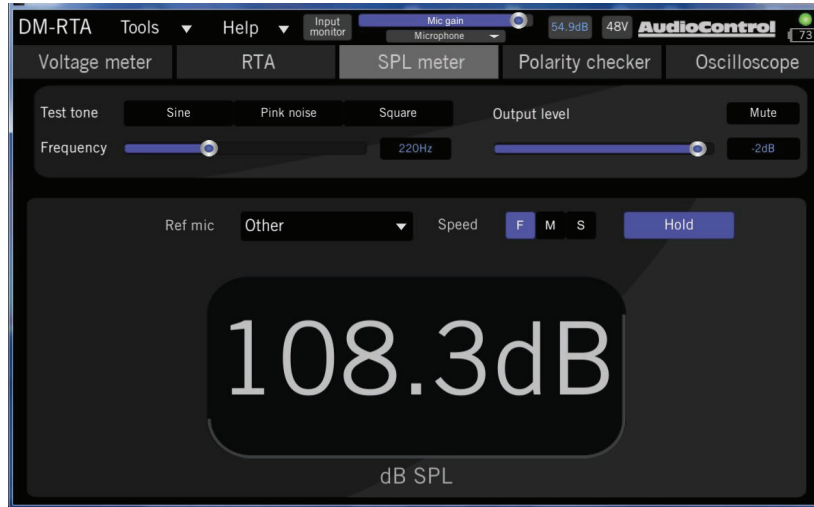

The SPL display allows you to measure the Sound Pressure Level of your system using a reference microphone. You can investigate the overall SPL in your system, and in different parts of the room for example, allowing you to adjust the system for audience pleasure and audience hearing safety.

The display shows the SPL level in dB, and you are able to select our various calibration microphones, adjust the measurement speed, and to hold the current reading.

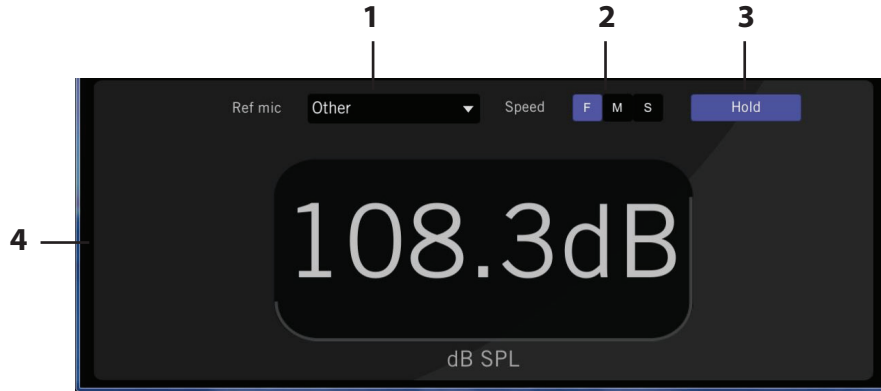

1. Reference Mic – This pull-down menu allows you to select the microphone, so its known properties will be used in the SPL calculations. Select “Other” if your microphone is not listed.

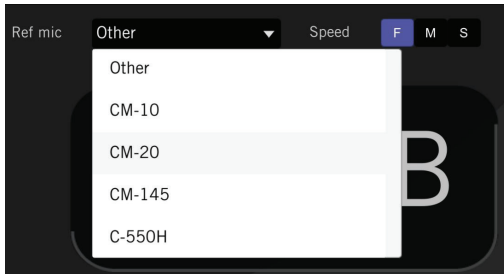

- 2. Speed** – Select from Fast, Medium, and Slow, to suit your preference and the sound material you are measuring.
- 3. Hold** – Press this to hold the current reading in the display.
- 4. SPL Display** – This is the measured SPL display in dB.

Polarity Checker

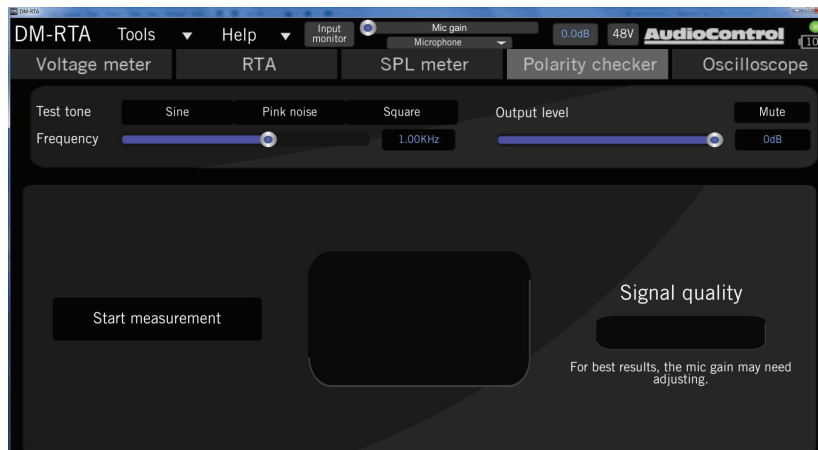

The Polarity Checker display allows you to measure the polarity of the speakers in your system using a microphone. This will allow you to locate any speakers that are wired out of phase. Not that it was you that wired them that way, of course. This is a no-guilt operation designed to help you fix the problem quickly before anyone notices.

Connect a microphone to the XLR input of the DM-RTA, and connect one of the audio outputs of the DM-RTA to play in the loudspeakers of your system. During the test, the DM-RTA will play a test signal into your system, and the microphone signal is then analysed.

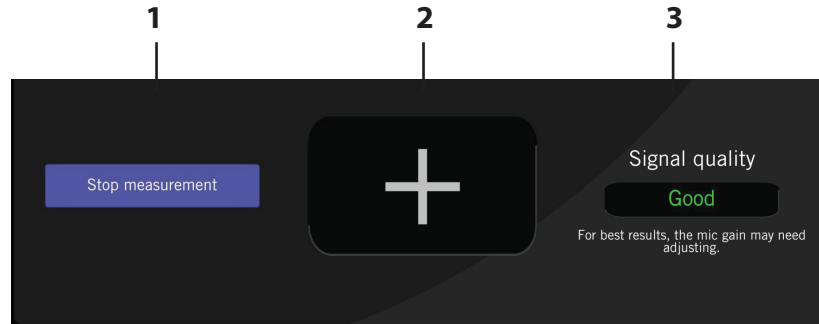

- 1. Start/Stop Measurement** – Press this button to start the measurement. An audio test signal will play in your system, after a short warning.

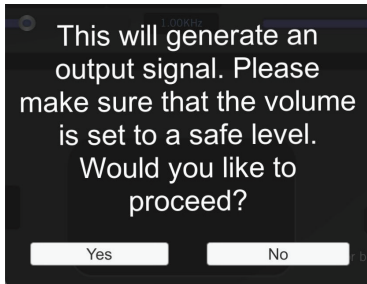

- 2. Polarity Display** – A Plus here (+) indicates that the loudspeaker you are measuring is correctly wired in-phase (but check that the Signal Quality (3) is good before celebrating).

A Minus here (-) indicates that whoever did the speaker wiring, it wasn't you. Check the wiring, and swap the wires at the amplifier end, or speaker end (but not both) whichever is most convenient.

- 3. Signal Quality** – If the signal picked up by the microphone is too low in level for an accurate reading, then try adjusting the microphone gain control at the top of the display, until the level is more suitable, or increase your amplifier to bring up the output levels in your loudspeakers.

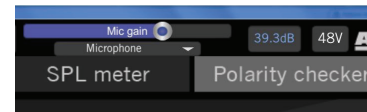

Oscilloscope



The Oscilloscope display allows you to measure the variation of your incoming audio signal level with time. This will allow you to identify many qualities of your system, for example if the output from your amplifier is distorted in any way (clipping) from the nice signals you are putting in.

The display shows time along the horizontal axis, and the signal level along the vertical axis. As an example, if you were playing a sine wave test tone, if you adjust the test frequency, then you will see the sine wave peaks move closer or further apart in the display. If you adjust the test tone output level, then the sine wave will increase or decrease in vertical voltage range.

The vertical scale and horizontal scale can both be adjusted to suit your test signal and get the best display.

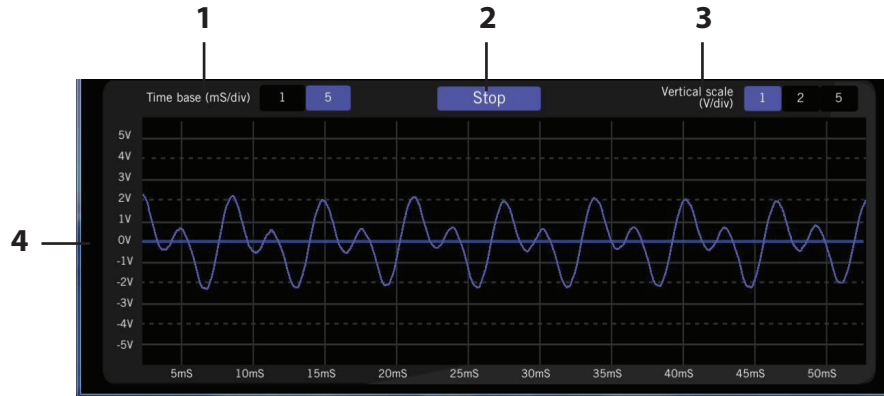

- 1. Time Base** – This allows you to adjust the horizontal time display from 1 mS per division, to 5 mS per division.
- 2. Stop** – This allows you to freeze the current display, giving you the chance to take a screenshot with your computer to show mum.
- 3. Vertical Scale** – This allows you to adjust the vertical display from 1 Volt per division, 2 Volts per division, or 5 Volts per division.

Example: Sine Wave

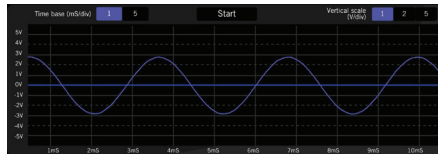

Example: Pink Noise

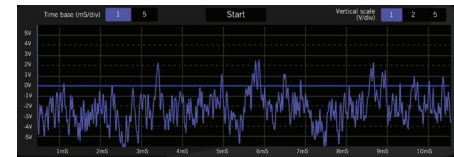

Example: Square Wave

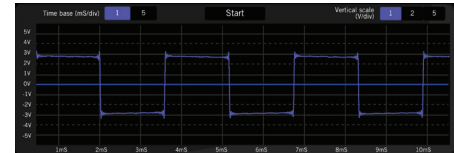

Specifications

As technology advances, AudioControl reserves the right to continuously change our specifications and fulfill our prime directive and audio destiny.

DM-RTA

Maximum input level (line)	10 Vrms
Maximum input level (speaker)	40 Vrms
RCA Input impedance	3.24 kΩ
¼" input impedance	3.24 kΩ
XLR input impedance	10 kΩ
SPK Input impedance	16 kΩ
Maximum output voltage level from internal signal generator: sine, pink and square wave	
¼" output	5 Vrms
RCA output	5 Vrms
Max output voltage when monitoring the input (limited by the output of the DAC)	5 Vms
TRS ¼" output impedance	51Ω
RCA output impedance	51Ω
Accuracy	+/- 1%
Digital (coax only) output impedance	75Ω
Battery Life	approximately 5 Hours
Dimensions	8.00 x 4.80 x 2.31"
Weight	1.9 lbs

©2018 AudioControl. All rights reserved.

Dimensions

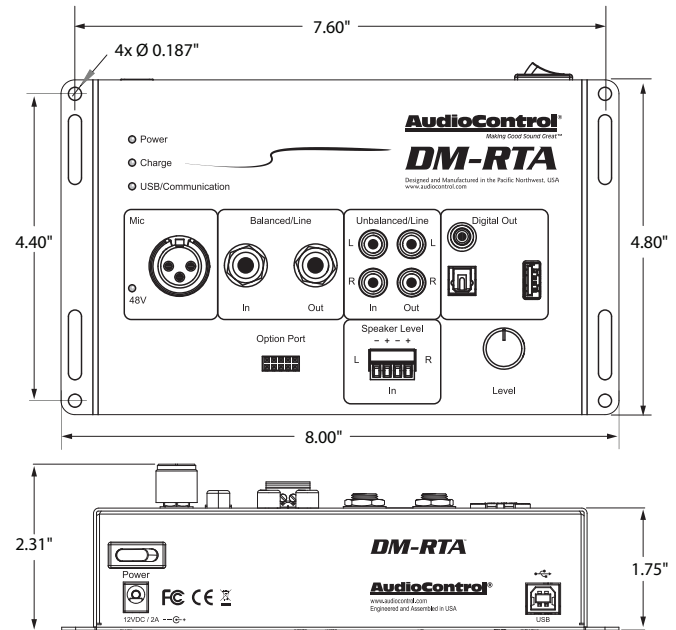

DM-RTA Block Diagram

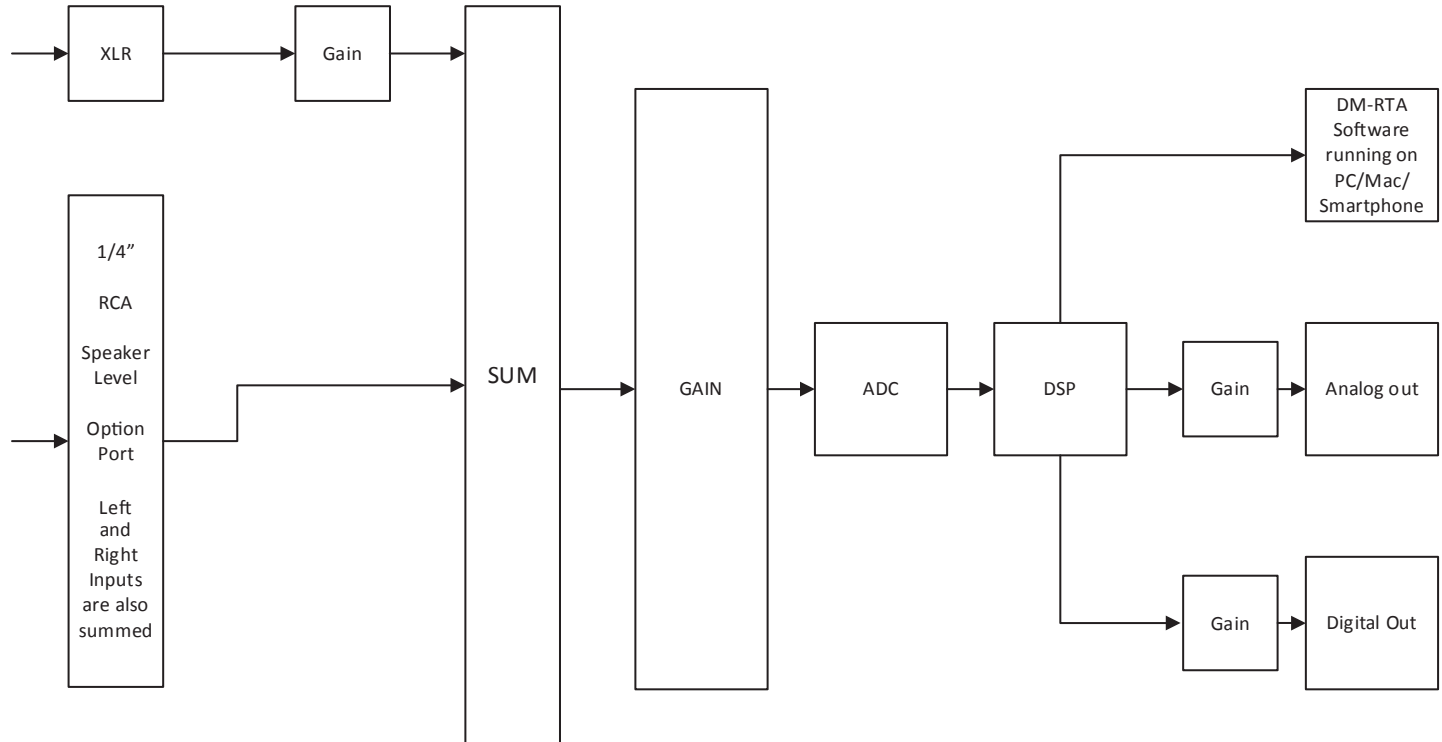

Service

First, if you need service, it is probably best to go and see a trained health care professional.

Please visit our AudioControl knowledge base at web address: www.audiocontrol.com/knowledge-base. This may help you find a solution to your problem.

If you are fairly sure that the DM-RTA needs service, then please contact AudioControl, either by e-mail or phone. We will verify if there is anything wrong in the system that you can correct yourself, or if it needs to be sent back to our factory for repair.

Please include the following items when returning the unit:

1. A copy of your proof of purchase. No originals please. We cannot guarantee returning them to you.
2. A brief explanation of the trouble you are having with the unit. (You'd be surprised how many people forget this.) If you can supply a really detailed description of the problem, this would be so much better, and our service technicians may add you to their Christmas Card list. Please include any notes about the system and other components you are using. Is it an intermittent problem, or all the time?
3. A return street address. (No PO Boxes, please).

4. A daytime phone number in case our technicians have a question about the problem you are having, or if they are just feeling lonely.
5. Package the unit in the original packaging if you still have it, and if the kids are not using it for art supplies. Use great care and plenty of good packing materials to protect the unit and prevent it from moving about inside the box. Do not use loose materials like packing peanuts or real peanuts.

You are responsible for the freight charges to us, but we'll pay the return freight back as long as the unit is under warranty. We match whatever shipping method you use to send it to us, so if you return the unit overnight freight, we send it back overnight. We recommend United Parcel Service (UPS) for most shipments.

Repair service is available at:

Attention: Service Department
22410 70th Avenue West,
Mountlake Terrace,
WA 98043 USA

Phone 425-775-8461
FAX 425-778-3166

e-mail: sound.great@audiocontrol.com

The Warranty

People are confused by warranties! Lots of fine print. Months of waiting around. Well, fear no more AudioControl is here. Our warranty is designed to make you rave about AudioControl. It's a warranty that looks out for our customers, plus helps you resist the temptation to have your friend, "who is good with electronics", try to repair your AudioControl product. So go ahead, read this warranty, then register your AudioControl product at www.audiocontrol.com/product-registration.

Our warranty has conditional conditions! "Conditional" doesn't mean anything ominous. The Federal Trade Commission tells all manufacturers to use the term to indicate that certain conditions have to be met before they'll honor the warranty. If you meet all of these conditions, AudioControl will, at its discretion, repair or replace any AudioControl products that exhibit defects in materials and/or workmanship during the warranty on your product for five (5) years from the date you bought it, and we will fix or replace it, at our option, during that time.

Here are the conditional conditions:

1. You must fully register your purchase within 15 days of the purchase date by going to the AudioControl product registration page at www.audiocontrol.com/product-registration. Failure to register your product will negate the warranty.
2. You need to hold on to your sales receipt! All warranty service requires original sales receipt documentation. The warranty only applies to the original purchaser from an authorized AudioControl dealer. Note: Products purchased from unauthorized dealers are not covered under warranty.
3. If purchased through an authorized AudioControl dealer, the warranty is five years.
4. Our warranty covers AudioControl products that have been installed according to the instructions in the owner's manual.
5. You cannot let anybody who isn't: (A) the AudioControl factory; or (B) somebody authorized in writing by AudioControl service your AudioControl product. If anyone other than (A), or (B) messes with your AudioControl product, the warranty is void.
6. The warranty is void if the serial number is altered, defaced or removed, or if your product has been used improperly. Now that may sound like a big loophole, but here is what we mean by this: Unwarranted abuse is: (A) physical damage (don't use your product to level your dining room table); (B) improper connections (120 volts into the RCA jacks can fry the poor thing); (C) sadistic things! This is the best product we know how to build, but for example if you mount it to the front bumper of your car, drop it over the Niagara Falls or use it for Clay Pigeon shooting practice, something will go wrong.

Assuming you conform to 1 through 6, and it really isn't all that hard to do, we get the option of fixing your product or replacing it with a new one at our discretion.

In the event that your product is out of warranty or not covered under our warranty you may request to have any damage repaired at our normal "Out of Warranty" repair cost.

Legalese Section

This is the only warranty issued by AudioControl. This warranty gives you specific legal rights, and you may also have rights that vary from state to state. Promises of how well your AudioControl product will work are not implied by this warranty. Other than what we've said we'll do in this warranty, we have no obligation, express or implied. We make no warranty of merchantability or fitness for any particular purpose. Also neither we nor anyone else who has been involved in the development or manufacture of the unit will have any liability of any incidental, consequential, special or punitive damages, including but not limited to any lost profits or damage to other parts of your system by hooking up to the unit (whether the claim is one for breach of warranty, negligence of other tort, or any other kind of claim). Some states do not allow limitations of consequential damages.

The can't dance two-step!

