

JL AUDIO[®]
A Garmin Brand



Stealthbox[®]

INSTALLATION GUIDE
for the

SBX-POL-RZR19RSUB/10TW3

SKU# 94796

2019 - 2024 Polaris RZR Pro XP, & Turbo R 4-Seat

Enclosure Type: Sealed

Driver Type: 10TW3-D8

Nominal Impedance: 4 ohms

Continuous Power Handling: 400 watts (RMS method)

! IMPORTANT

- Installation requires appropriate tools and safety equipment. Professional installation is recommended.
- If you prefer to perform your own installation, please read this installation guide completely before beginning.
- Before cutting or drilling, check for potential obstacles behind mounting surfaces.
- Mount this product securely to prevent damage or injury in severe conditions.

INSTALLATION
DIFFICULTY:

3 ^{OUT} **5**

ESTIMATED TIME:
2 HOURS



INCLUDED HARDWARE

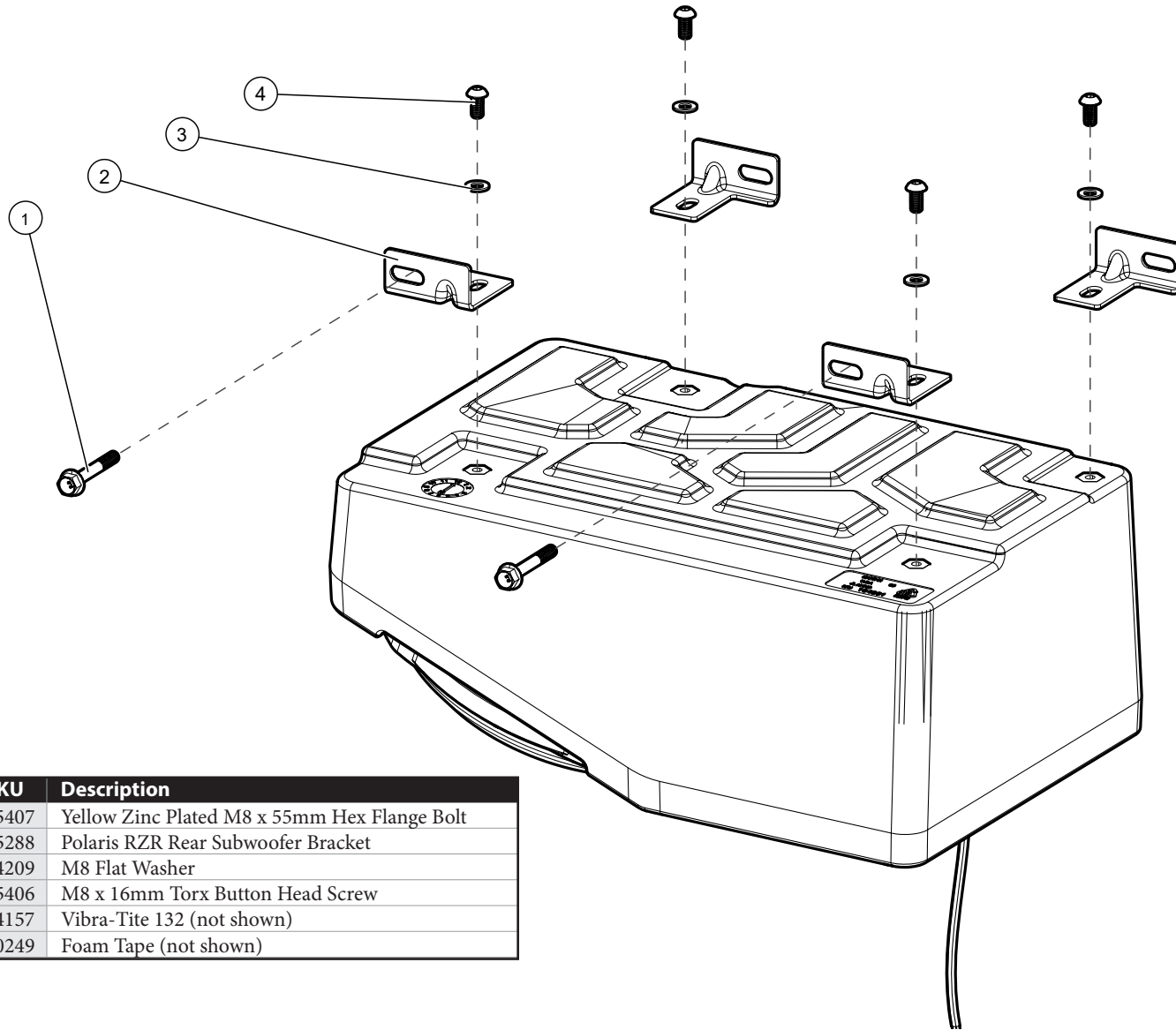

BOM ID	Qty	SKU	Description
1	2	155407	Yellow Zinc Plated M8 x 55mm Hex Flange Bolt
2	4	155288	Polaris RZR Rear Subwoofer Bracket
3	4	154209	M8 Flat Washer
4	4	155406	M8 x 16mm Torx Button Head Screw
-	1	194157	Vibra-Tite 132 (not shown)
-	1	150249	Foam Tape (not shown)



STEP 1

Empty the rear seat area.



STEP 2

Undo the straps, release the seat belt buckles, and pass the seat belts through the openings in the seats.



STEP 3

Unlatch and remove the rear seat backs.



STEP 4

Unclip and remove the upper cover panel.



STEP 5

Unclip and remove the lower cover panel.

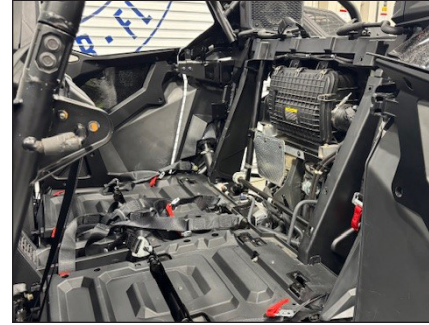

STEP 6

Fold the seat bottoms forward.

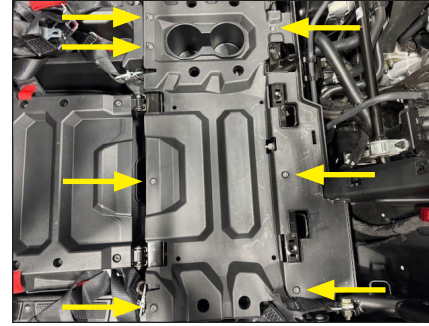

STEP 7

Remove the indicated screws from the under seat cover panel, and repeat for the opposite side. Note the position of each screw for proper reassembly.



STEP 8

Remove the under seat cover panel.

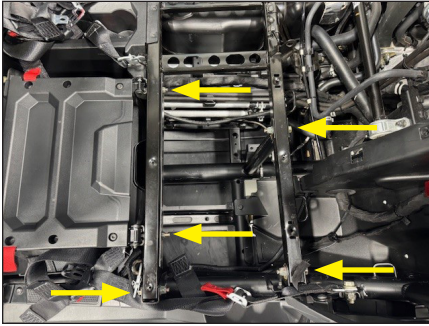

STEP 9

Remove the indicated bolts and nuts from the seat frame, and repeat for the opposite side.

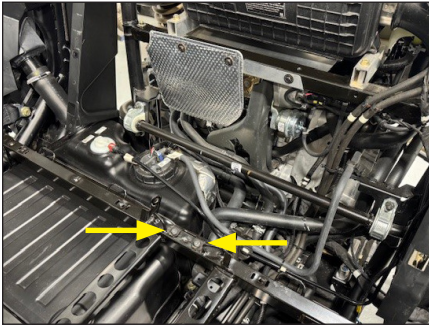

STEP 10

Remove the indicated screws from the seat frame.



STEP 11

Remove the seat bottoms from the seat frame, and move the seat belts away from the frame.

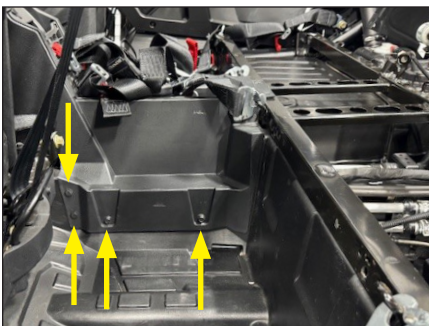

STEP 12

Remove the two screws and two clips from the base of the center console, and repeat for the opposite side.

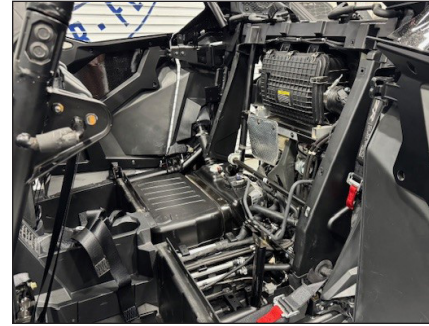

STEP 13

Carefully lift and remove the seat frame from the vehicle.

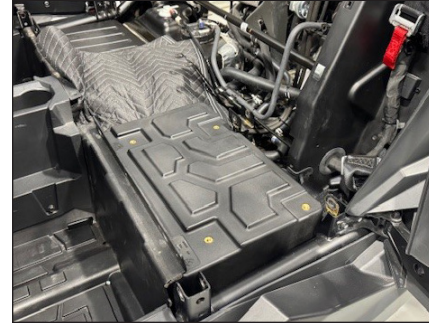

STEP 14

Place a blanket in the cavity to protect the enclosure, then carefully place the enclosure into position, as shown.



STEP 15

Carefully set the seat frame back into position.

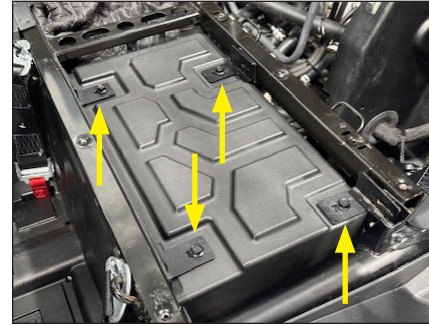

STEP 16

Align each of the four Enclosure Brackets at the top of the enclosure, as shown. Slide an M8 Flat Washer over an M8 x 16mm Torx Button Head Screw. Apply Vibra-Tite 132 to the screw, and pass the assembly through the lower slot in an Enclosure Bracket, into the threaded insert on top of the enclosure, and hand tighten.

Repeat for all four Enclosure Brackets.

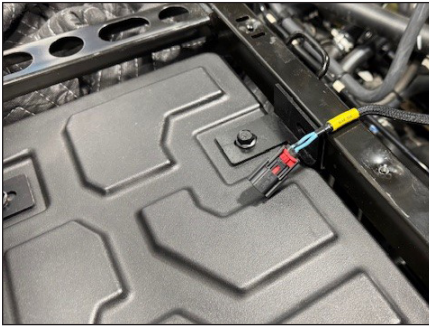

STEP 17

For vehicles equipped with a SlamPak® system, plug the Molex connector from the enclosure harness into the mating connector of the SlamPak® harness.

For all other vehicles, cut the Molex connector from the enclosure harness, and connect the subwoofer wires to the amplifier.
 Light Blue = Subwoofer Positive (+)
 Light Blue / Black = Subwoofer Negative (-)

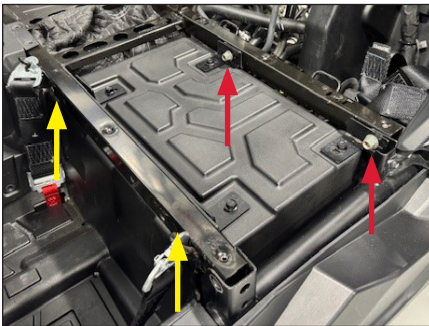

STEP 18

At the red arrow locations, reinstall two factory bolts through the rear Enclosure Brackets and seat frame. At the yellow arrow locations, reinstall the seat bottom using the included Yellow Zinc Plated M8 x 55mm Flanged Hex Bolts through the seat frame and front Enclosure Brackets.

Reinstall the remaining factory seat frame hardware. Fully tighten all the Enclosure Bracket hardware.



STEP 19

Reinstall the under seat cover panel.



STEP 20

Reinstall the lower cover panel, upper cover panel, center console, seat backs, and seat belts.

CONGRATULATIONS!

You have completed the installation for this model! Enjoy your new Stealthbox®!



(954) 443-1100

www.jlaudio.com

Please review the warranty information included with each product for details. Warranty is valid only if the product was purchased from an Authorized JL Audio Dealer. Authorized dealer status can be verified with the Dealer Locator on www.jlaudio.com. International Warranty: Please contact your country's JL Audio distributor for specific warranty details.
 © Garmin Ltd. or its subsidiaries. All rights reserved. • Garmin, JL Audio, Stealthbox, and How we play, are trademarks of Garmin Ltd. or its subsidiaries and are registered in one or more countries, including the U.S. The JL Audio logo, the How we play logo, the Stealthbox logo, and the SBX logo are trademarks of Garmin Ltd. or its subsidiaries. Product images shown are for illustrative purposes only and may differ from the actual product. Due to continuous product development, all specifications are subject to change without notice.

JLA-SKU# 011796 • ver. 03.27.2025 • 10369 NORTH COMMERCE PARKWAY • MIRAMAR, FLORIDA • 33025 • USA



011796